

DIGITAL PIANO

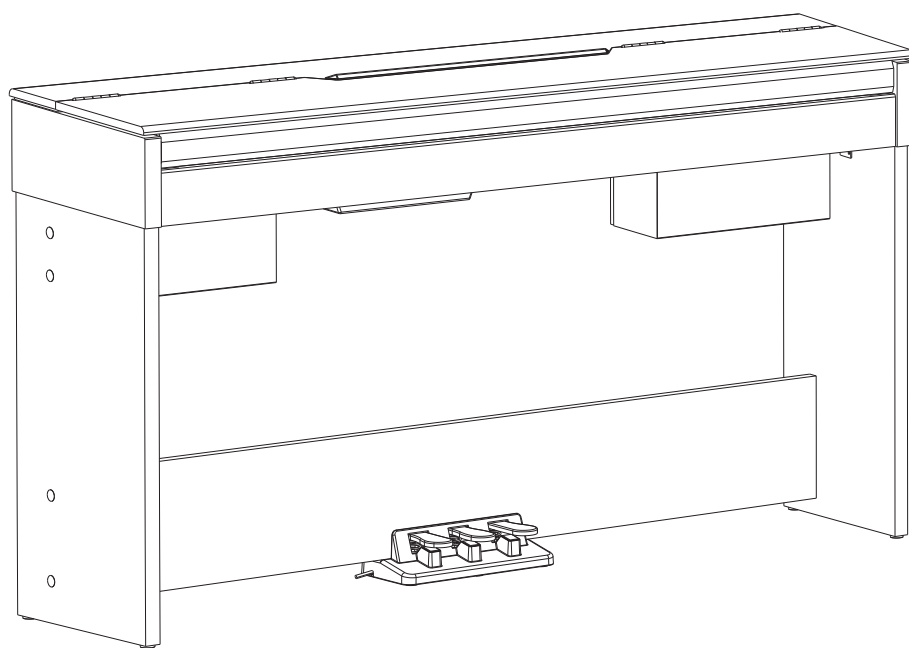

Owner's Manual

THE FCC REGULATION WARNING (for USA)

This equipment has been tested and found to comply with the limits for a Class B digital device, pursuant to Part 15 of the FCC Rules.

These limits are designed to provide reasonable protection against harmful interference in a residential installation. This equipment generates, uses, and can radiate radio frequency energy and, if not installed and used in accordance with the instructions, may cause harmful interference to radio communications. However, there is no guarantee that interference will not occur in a particular installation. If this equipment does cause harmful interference to radio or television reception, which can be determined by turning the equipment off and on, the user is encouraged to try to correct the interference by one or more of the following measures:

- Reorient or relocate the receiving antenna.
- Increase the separation between the equipment and receiver.
- Connect the equipment into an outlet on a circuit different from that to which the receiver is connected.
- Consult the dealer or an experienced radio/TV technician for help.

Unauthorized changes or modification to this system can void the user's authority to operate this equipment.

CAUTION

The normal function of the product may be disturbed by Strong Electro Magnetic Interference. If so, simply reset the product to resume normal operation by following the owner's manual. In case the function could not resume, please use the product in other location.

PRECAUTIONS

PLEASE READ CAREFULLY BEFORE PROCEEDING

Please keep this manual in a safe place for future reference.

Power Supply

Please connect the designated AC adaptor to an AC outlet of the correct voltage.

Do not connect it to an AC outlet of voltage other than that for which your instrument is intended.

Unplug the AC power adaptor when not using the instrument, or during electrical storms.

Connections

Before connecting the instrument to other devices, turn off the power to all units. This will help prevent malfunction and / or damage to other devices.

Location

Do not expose the instrument to the following conditions to avoid deformation, discoloration, or more serious damage:

- Direct sunlight
- Extreme temperature or humidity
- Excessive dusty or dirty location
- Strong vibrations or shocks
- Close to magnetic fields

Interference with other electrical devices

Radios and televisions placed nearby may experience reception interference. Operate this unit at a suitable distance from radios and televisions.

Cleaning

Clean only with a soft, dry cloth.

Do not use paint thinners, solvents, cleaning fluids, or chemical-impregnated wiping cloths.

Handling

Do not apply excessive force to the switches or controls.

Do not let paper, metallic, or other objects into the instrument. If this happens, unplug the AC adaptor from the wall outlet. Then have the instrument inspected by qualified service personnel.

Disconnect all cables before moving the instrument.

Panel Description	4
Front Panel.....	4
Rear Panel.....	5
Setup	6
Part List.....	6
Setup Guide.....	6
Power Supply.....	8
Connections	9
Connecting a pair of Headphones.....	9
Connecting an Audio Equipment.....	9
Connecting an MP3/CD Player.....	9
Connecting a Computer.....	9
Adjusting the Volume	10
Listening to the Song	10
Playing Demo song.....	10
Playing Song.....	10
Practice Song.....	10
Playing Voices	11
Selecting Voice.....	11
Playing two Voice Simultaneously.....	11
Playing a Lower Voice.....	11
Playing Voice Demo.....	11
Touch Response.....	11
Digital Effects	12
Reverb and Chorus Effect.....	12
EQ Effect.....	12
Metronome	12
Tempo	12
Transpose	13
Tune	13
Beep Tone	13
Troubleshooting	14
Specifications	14
Appendices	15
Voice List.....	15
Song List.....	15
MIDI Implementation List.....	16

Panel Description

Front Panel

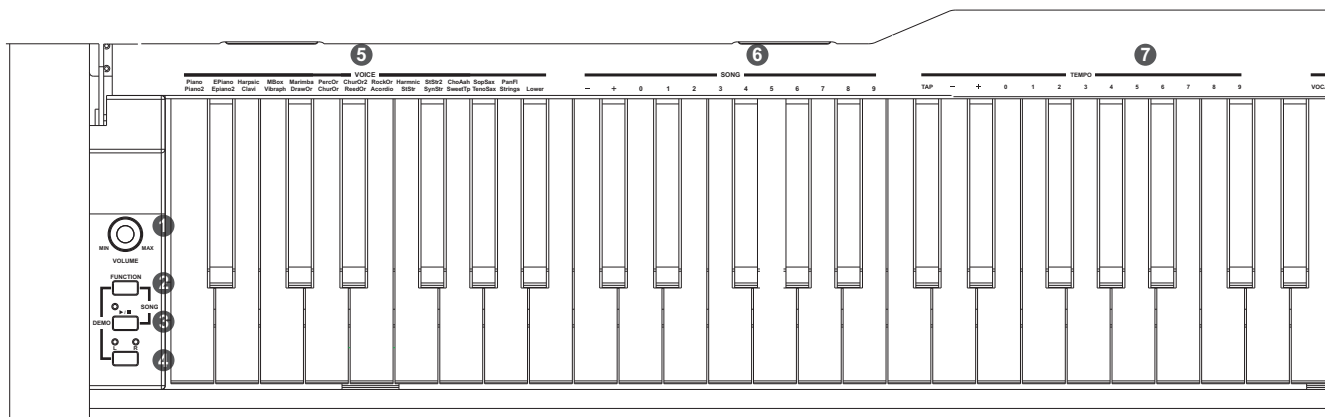

1. MASTER VOLUME

Adjust the master volume.

2. FUNCTION Button

Hold down this button and press the special keys to realize different functions.

3. START/STOP Button

Start/stop the song playing.

4. L/R Button

In song mode, you can press [L/R] button to select which hand to practice.

5. VOICE SELECT Key

Hold down the [FUNCTION] button and press the key to select a voice.

6. SONG SELECT Key

Hold down the [FUNCTION] button and press the key to select a song.

7. TEMPO ADJUST Key

Hold down the [FUNCTION] button and press the key to adjust the current tempo.

8. POWER ON / OFF

Turn the power ON or OFF.

9. PHONES 1 AND 2

Connect the headphone

10. USB Jack

Connect to a computer.

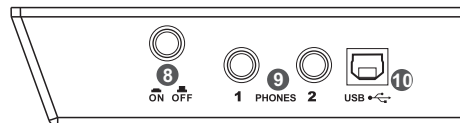

11. SOFT Pedal

Step on the soft pedal, all notes played on the keyboard would have a softer effect.

12. SOSTENUTO Pedal

Step on the sostenuto pedal, the notes played before you step on would have a sustain effect.

13. SUSTAIN Pedal

Step on the sustain pedal, all notes played on the keyboard would have a longer sustain.

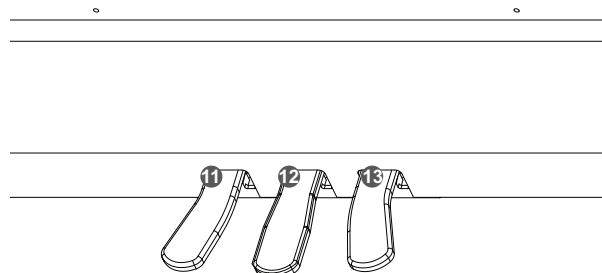

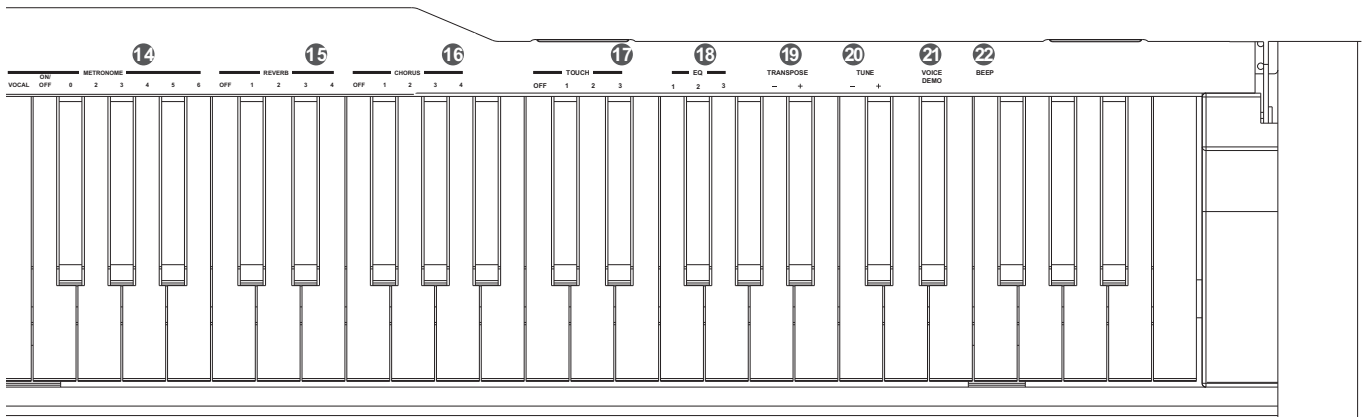

14. METRONOME Key

Hold down the [FUNCTION] button and press the [ON/OFF] key to turn the metronome ON or OFF. Hold down the [FUNCTION] button and press the other key to select the time signature.

15. REVERB Key

Hold down the [FUNCTION] button and press the [ON/OFF] key to turn reverb effect ON or OFF. Hold down the [FUNCTION] button and press the other key to select the reverb type.

16. CHORUS Key

Hold down the [FUNCTION] button and press the [ON/OFF] key to turn chorus effect ON or OFF. Hold down the [FUNCTION] button and press the other key to select the chorus type.

17. TOUCH Key

Hold down the [FUNCTION] button and press the key to select different touch response level.

18. EQ Key

Hold down the [FUNCTION] button and press the key to select the EQ type.

19. TRANPOSE Key

Hold down the [FUNCTION] button and press the key to adjust the transpose value from -12 to 12 semitones.

20. TUNE Key

Hold down the [FUNCTION] button and press the key to adjust the tune value from -50 to 50 (stand for -100 to 100 cents).

21. VOICE DEMO Key

Hold down the [FUNCTION] button and press the key to start/stop the voice demo playing.

22. BEEP Key

Hold down the [FUNCTION] button and press the key to turn the prompt tone ON or OFF.

Rear Panel

23. AUX IN Jack

Connect an external sound source, such as an MP3 or CD player.

24. AUX OUT Jack

Connect the audio equipment.

25. DC IN Jack

Connect the DC 15V power adaptor.

26. SPEAKER Jack

Connect the speaker.

27. PEDAL Jack

Connect to the pedals.

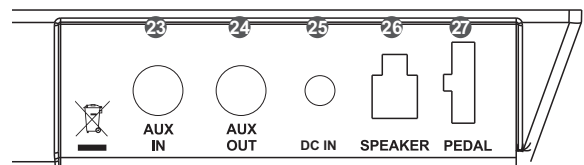

Setup

This section contains information about setting up your instrument and preparing to play. Please go through this section carefully before turning the power on.

Part List

Before you proceeding to assemble the stand, get a Philip's screwdriver (not supplied). Make sure you have the following parts, which are supplied into package.

1.	Piano body
2.	ST side board left
3.	Left speaker box
4.	Speaker line
5.	Right speaker box
6.	Pedal line
7.	Hand screw (2)
8.	Pedal box
9.	Φ6x50 "+" screw (8)
10.	Screw cap (8)
11.	ST side board right
12.	Horizontal hole nut(4)
13.	4x15BM "+" screw(2)
14.	Gasket(2)

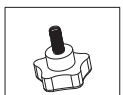
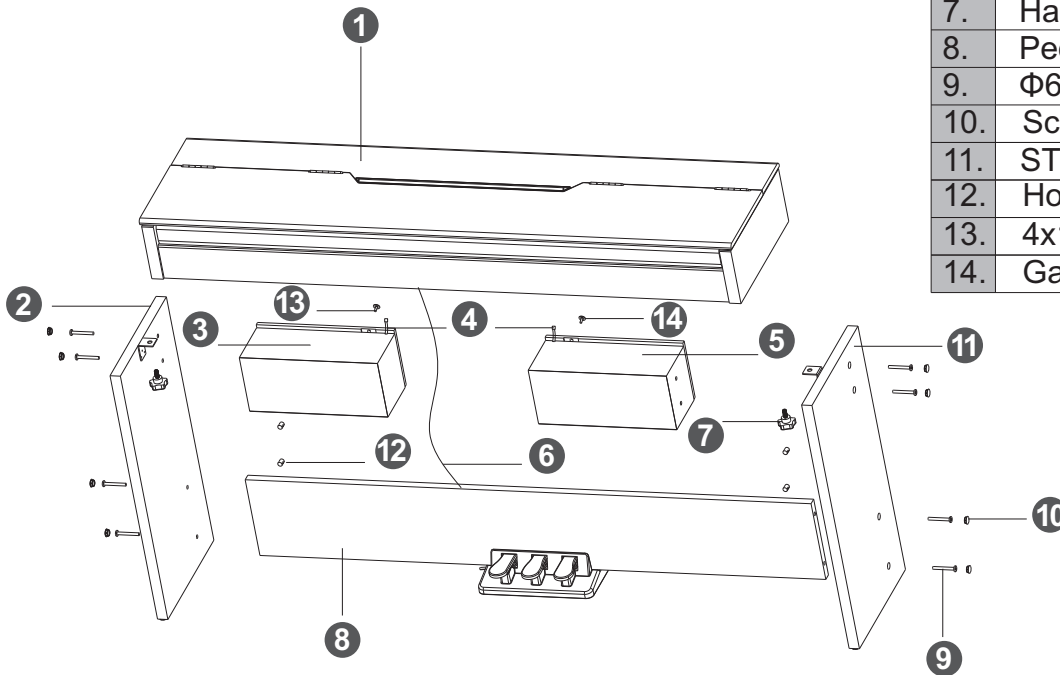

7. Hand screw (2)

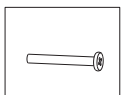

9. Φ6x50 "+" screw (8)

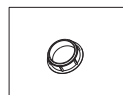

10. Screw cap (8)

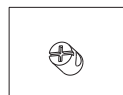

12. Horizontal hole nut(4)

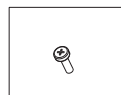

13. 4x15BM "+" screw(2)

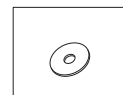

14. Gasket(2)

Setup Guide

STEP 1: First of all make 4 PCS Horizontal hole nut into the holes in the pedal box as picture shown, ensure that Horizontal hole nut hole is aligned with the pedal box holes, then use 4 PCS Φ6x50 screws to fix the left/right ST board to the pedal box, and cover the screw cap as shown.

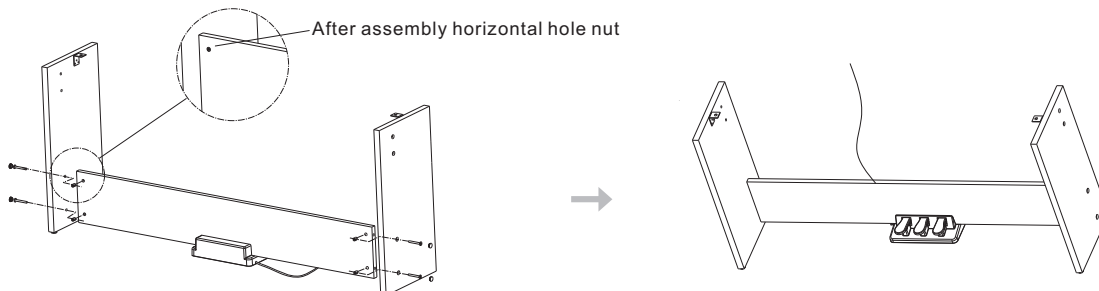

STEP 2: With 4 pcs $\Phi 6 \times 50$ "+" screws to fix the Speaker box to the ST side boards and cover the screw caps as shown.

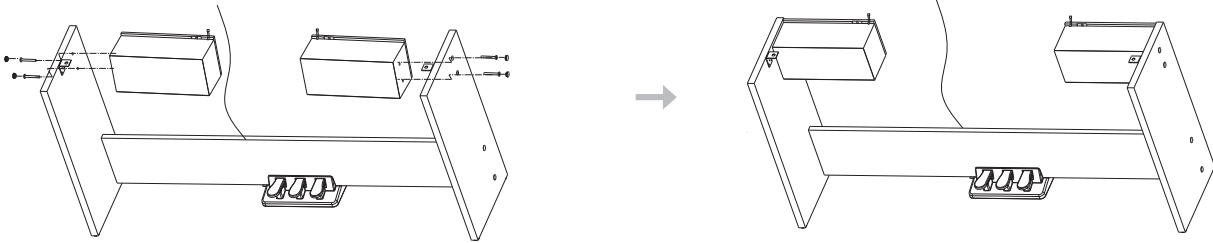

STEP 3: With 2 pcs hand screw fix the piano body and piano foot part together as shown.



STEP 4: Use 2 PCS 4 x15 screws and gasket to fix Left/Right speakers box, link the pedal line and speaker line according to the label, then power it up.

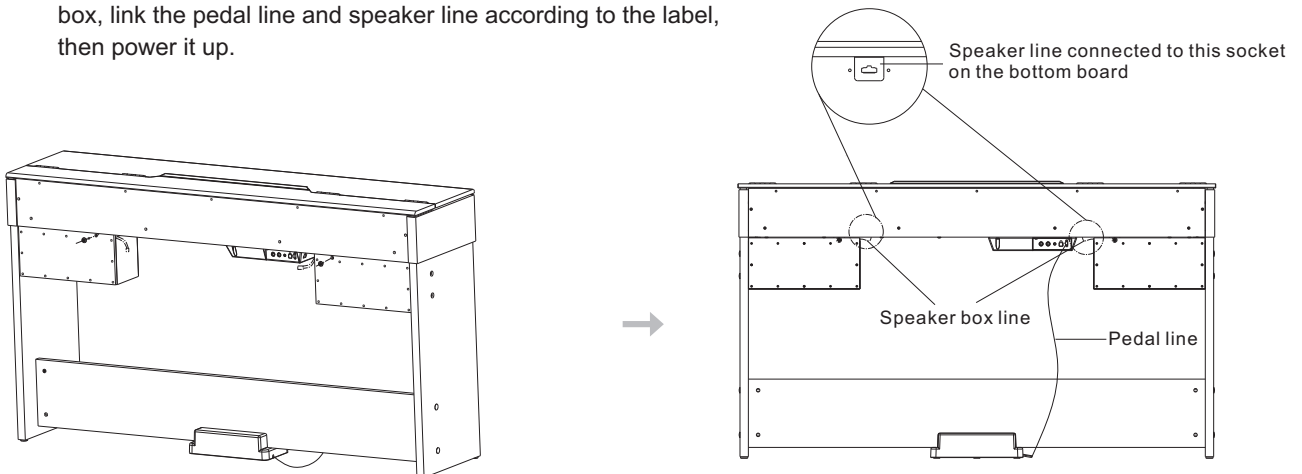

Setup

Power Supply

1. Please make sure that POWER ON/OFF switch of the instrument is set to OFF. Then turn the [VOLUME] knob to the minimum volume level.

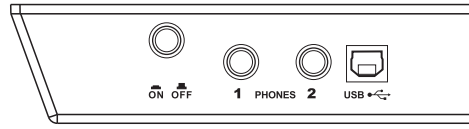

2. Connect the AC adaptor to the power supply jack.

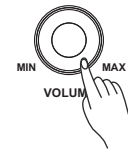

3. Plug the AC adaptor into an AC outlet. And when turning the power OFF, please simply reverse the procedure please.

4. Turn the power ON. The LED on the panel will light up.

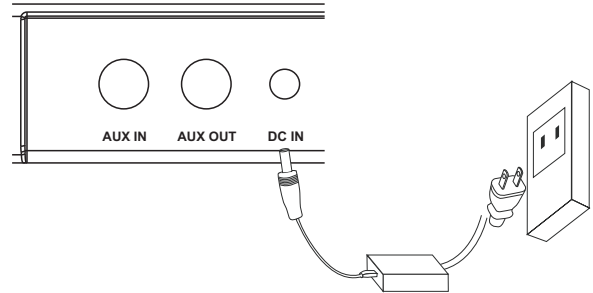

Note:

When the keyboard is not in use or during thunderstorm, please disconnect the power for safety purpose.

In order to save energy, we have designed the "Automatic Shutdown" function to the piano. With this function, the piano will shutdown automatically when you have left it idle for more than 30 minutes. If you don't need this feature, just press and hold the [A0] key (the 1st key) and turn it on.

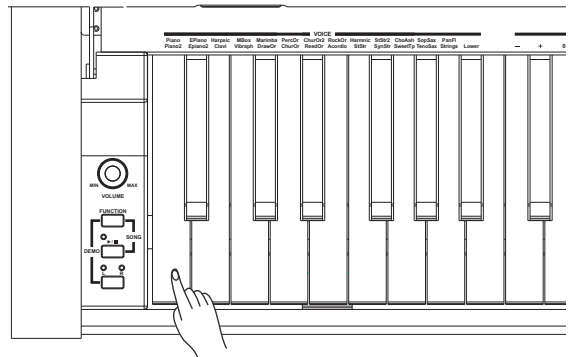

Connecting a pair of Headphones

A standard pair of stereo headphones can be plugged in here for private practice or late-night playing.

Jack1: When a pair of headphones is plugged into Jack 1, the internal stereo speaker system is automatically shut off. The sound can be heard from headphones.

Jack2: When a pair of headphones is plugged into the Jack 2, the sound can be heard from headphones and speakers of the instrument.

Note:

Do not listen with the headphones at high volume for long periods of time. Doing so may cause hearing loss.

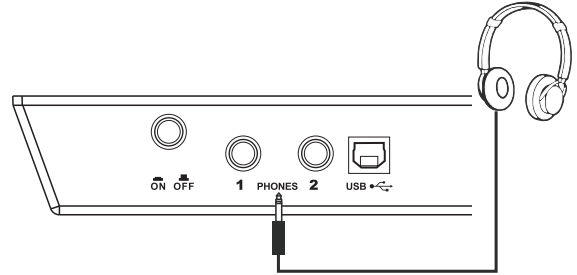

Connecting an Audio Equipment

The rear-panel AUX OUT jack delivers the output of the instrument for connection to a keyboard amplifier, stereo sound system, a mixing console, or tape recorder. Use an audio cord to plug into the AUX OUT jack located on the rear board then plug the other end of the cord into AUX IN of the amplifier.

Note:

To avoid damaging the speakers, please ensure that the volume has been set to the minimum level before connecting the power and other devices.

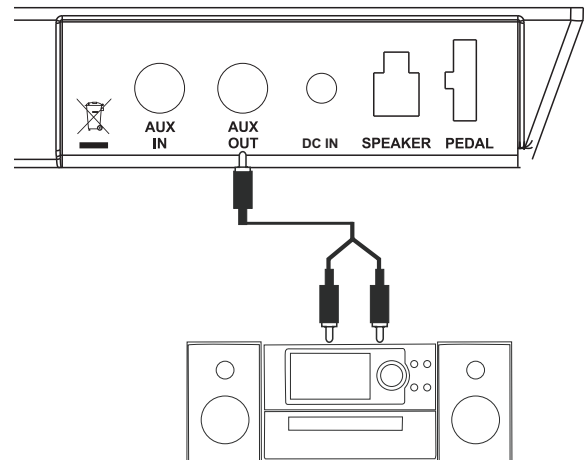

Connecting an MP3/CD Player

Connect the audio output of an MP3/CD player or other audio source to the stereo AUX IN jack on the rear panel. The input signal is mixed with the piano signal, allowing you to play along.

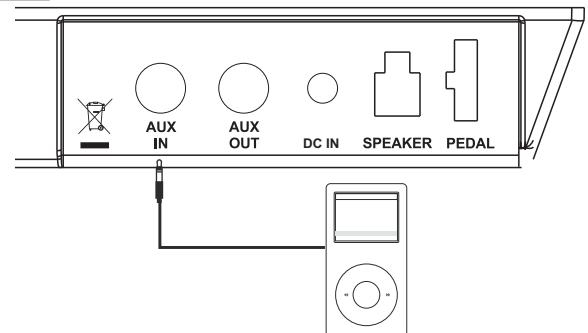

Connecting a Computer

Connect PC or other USB host devices that support USB audio. For devices with USB cable, you can simply connect the MIDI/USB converter to your USB connector on the device and plug the USB cable into the piano, after the driver is installed and initialization is finished, you can choose USB Audio Device in the device menu of the software to transfer midi data.

Note:

Do not select USB audio device in both of input and output setting together, otherwise the sound overlaps.

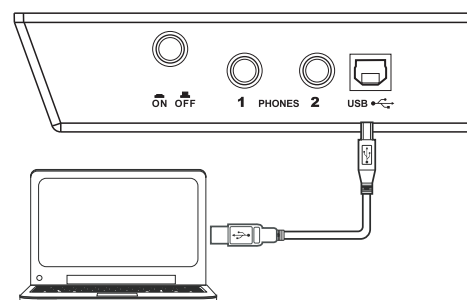

Adjusting the Volume

Rotate the [VOLUME] knob rightwards, the volume increases and vice versa.



Listening to the Song

Playing Demo song

While holding down the [FUNCTION] button, press [L/R] button to start the demo song playing. And all the LEDs on the panel will flash simultaneously.

Do it again or press [Start/Stop] button to stop playing, and the LED will stop flash.

Note:

The keyboard would be disabled when the demo song is playing.

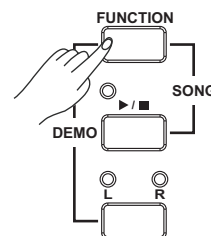

Playing Song

There are total 60 songs in this digital piano (see Appendix). Each song can be practiced in the MELODY OFF mode.

Start Song

While holding down the [FUNCTION] button, press [Start/Stop] button to start the song playing. All songs will be played in a loop.

Loop

While only press [Start/Stop] button, it will play the current song repeatedly.

Stop Song

Press [Start/Stop] button to stop the song playing.

Select Song

While holding down the [FUNCTION] button, press corresponding keys in SONG selection area to select your desired song.

Note:

1. Press [song +] and [song -] keys simultaneously to select the first song.
2. If you want to select song by the number keys, you should input 2 numbers. For example, if you want to select the eighth song, you should input "08".

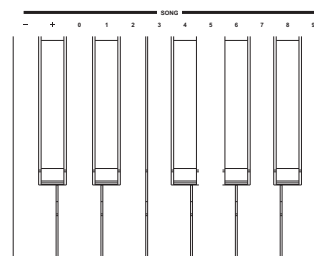
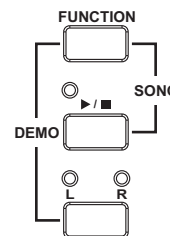

Practice Song

In the song mode, you can press [L/R] button to select which hand to practice and the status switch as following.

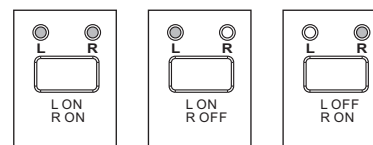

Selecting Voice

The instrument features 26 exceptionally realistic voices for you to choose. Please refer to Voice List. While holding down the [FUNCTION] button, press corresponding key in voice selecting area to select the voice you want. Now, You can play the keyboard and listen to the wonderful voice.

Note:

1. While changing a voice, pay attention to the rules: While holding down the [function] button, and press the same key again, the voice will be changed between the upper and lower key. When the upper/lower voice is on, and then you press another voice key, the corresponding upper/lower voice will be selected.
2. While voice is selected, the dual voice and lower voice will be turned off automatically.

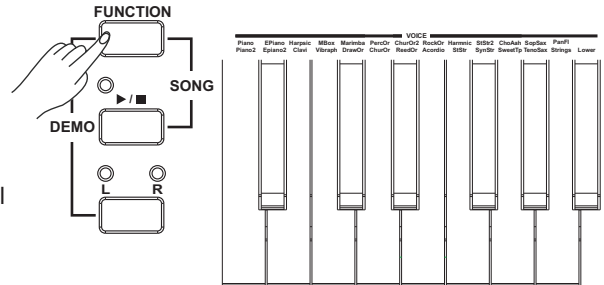

Playing two Voice Simultaneously

You can play two voices synchronously on the keyboard by selecting a dual voice. While holding down the [FUNCTION] button, press 2 keys simultaneously in voice selecting area. Press the first key to select the upper voice, press the second key to select the dual voice.

Notes:

While dual voice is turned on, lower voice would be turned off automatically.

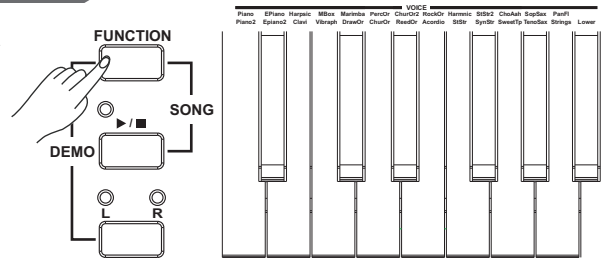

Playing a Lower Voice

While holding down the [FUNCTION] button, select the Lower on the keyboard. This will select Strings as lower voice and split the keyboard at F#3 automatically.

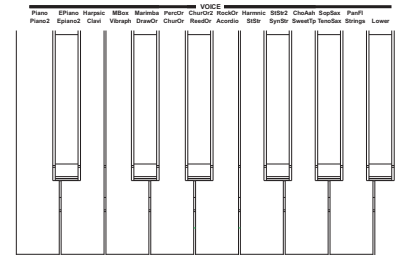
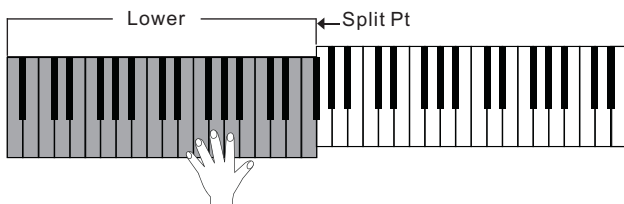

Playing Voice Demo

While holding down the [FUNCTION] button, press VOICE DEMO key to start the demo for the selected voice. Do it again to stop the voice demo playing. This instrument contains 26 voice demos.

Note:

In voice demo mode, the keyboard will be not available.

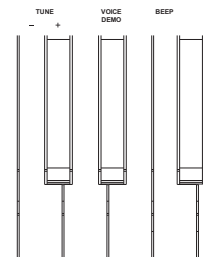

Touch Response

While holding down the [FUNCTION] button, press a key in the TOUCH selecting area to select different touch response level.

- 0: OFF
- 1: Soft
- 2: Medium
- 3: Hard

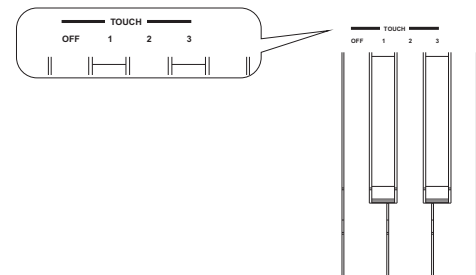

Digital Effects

Reverb and Chorus Effect

While holding down the [FUNCTION] button, press the corresponding keys in REVERB and CHORUS effect setting area to select the voice effect type.

Reverb Value:

- 0: OFF
- 1: Room
- 2: Small Hall
- 3: Large Hall
- 4: Stadium

Chorus Value:

- 0: OFF
- 1: Light Chorus
- 2: Medium Chorus
- 3: Deep Chorus
- 4: Flanger

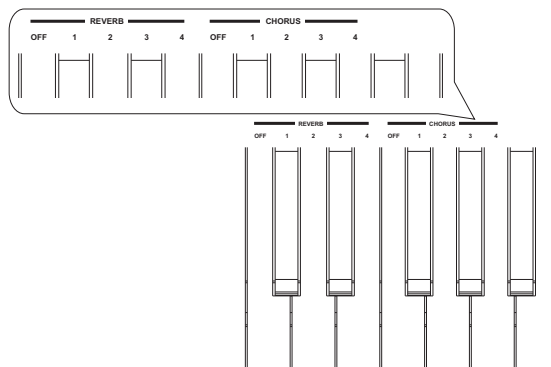

EQ Effect

The equalizer is the function of adjusting the sound value of the gain spectrum, gain setting can bring a different sound field effect.

This instrument contains 3 sets of equalizer for you to choose. While holding down the [FUNCTION] button, press the corresponding keys in EQ setting area to select the EQ type.

EQ Type:

- 1: Standard
- 2: Classical
- 3: Modern

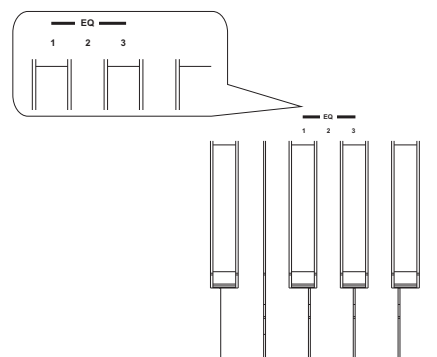

Metronome

Turn on the metronome:

While holding down the [FUNCTION] button, press METRONOME ON/OFF key to turn the metronome ON or OFF.

Select different time signature:

While holding down the [FUNCTION] button, select a demanded time signature by pressing the corresponding keys in metronome setting area. There are 6 types of time signature: 0, 2, 3, 4, 5, 6.

Select metronome voice:

While holding down the [FUNCTION] button, press VOCAL key to select metronome voice: human voice and normal voice.

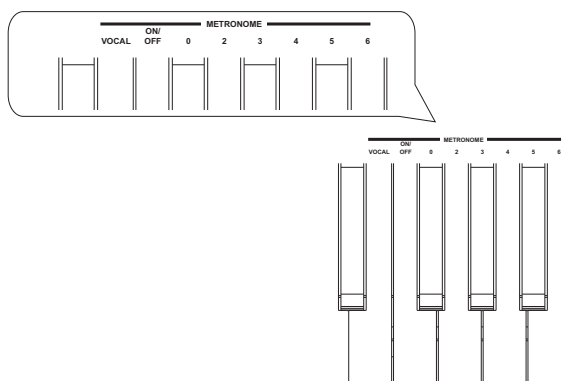

Tempo

While holding down the [FUNCTION] button, press corresponding keys in TEMPO selection area. You can change the tempo by input number or using tap tempo, or press tempo +/- keys to change current tempo.

Notes:

1. Press [tempo +] and [tempo -] keys simultaneously to set the tempo value back to the default (120).
2. The tempo range is :30 ~ 280
3. If you want to change tempo value by the number keys, you should input 3 numbers. For example, if you want to set the tempo value as 85, you should input "085" .

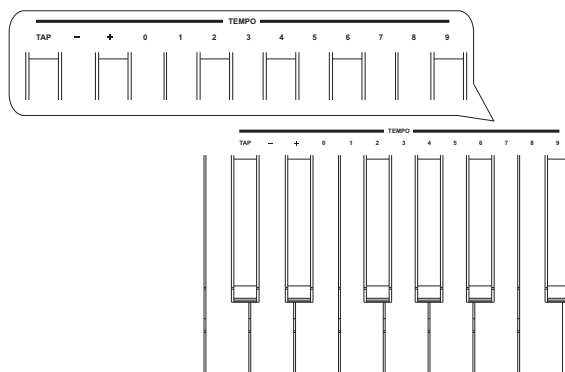

Transpose

While holding down the [FUNCTION] button, press transpose +/- key to adjust the transpose value from -12 to 12 semitones.

Note:

Press [transpose +] and [transpose -] keys simultaneously to set the transpose value back to the default (0 semitone).

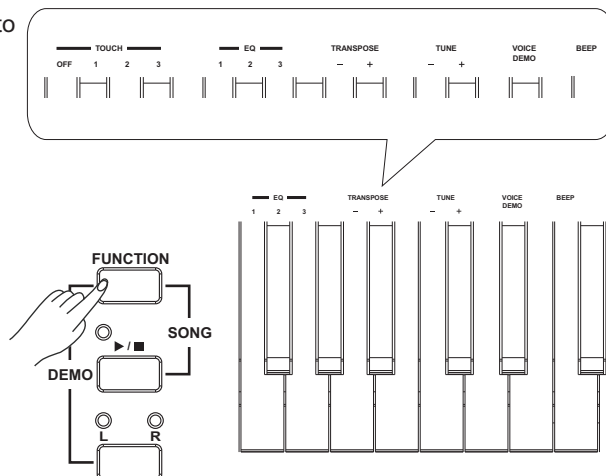

Tune

While holding down the [FUNCTION] button, press tune +/- key to adjust the tune value from -50 to 50 (stand for -100 to 100 cents).

Note:

Press [tune +] and [tune -] keys simultaneously to set the tune value back to the default (0 cent).

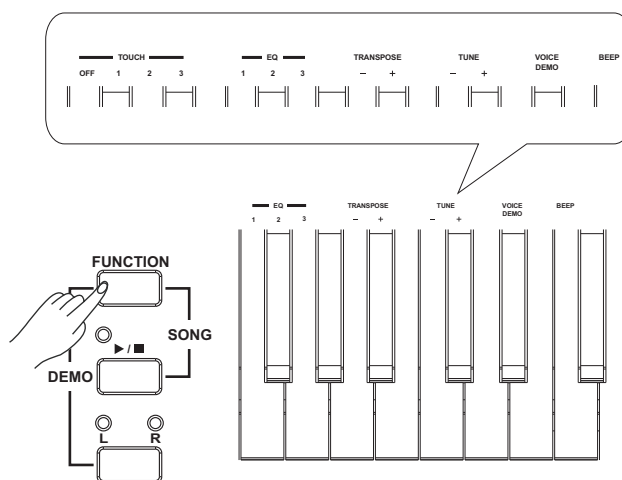

Beep Tone

While holding down the [FUNCTION] button, press beep key to turn the Beep Tone ON or OFF. The default setting is ON.

If you turn on the beep tone, you can hear a beep sound when you press a valid functional key while the [FUNCTION] button is held down.

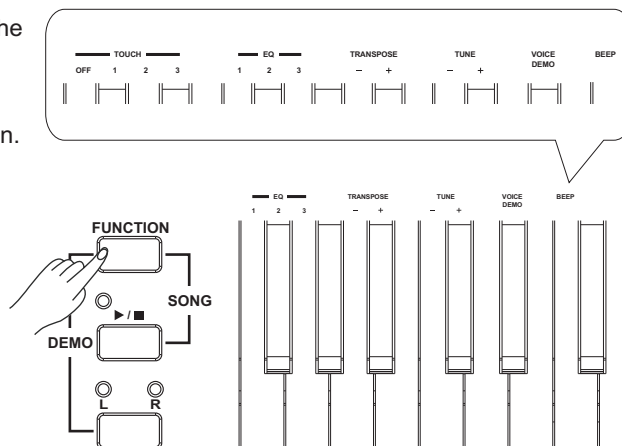

Troubleshooting

Problem	Possible Cause and Solution
The speakers produce a “pop” sound whenever the power is turned ON or OFF.	This is normal and is no cause for alarm.
No sound when the keyboard is played.	Make sure the voice volumes are set at appropriate levels.
When using a mobile phone, noise is produced.	Using a mobile phone in close proximity to the instrument may produce interference. To prevent this, turn off the mobile phone or use it further away from the instrument.

Specifications

Keyboard

88 Hammer-Action keys

Polyphony

64

Voice

26

Demo

1

Song

60

Tempo

30-280

Control Button

Power On/Off switch, Volume, Function, Start/Stop, L/R

Control Key

Voice Select Keys, Tempo Tap, Tempo +/-, Tempo Number Keys, Metronome On/Off, Metronome select keys, Reverb On/Off, Reverb Type Select Keys, Chorus On/Off, Chorus Type Select Keys, Touch On/Off, Touch Select Keys, EQ Type Select Keys,Transpose, Tune,Voice Demo Key, Vocal, Beep, Song Select Keys, Song+/-.

Connectors

DC IN, Headphones (2 standard. ¼” phone), AUX IN, AUX OUT, USB, Pedals (Sustain, Soft, Sostenuto)

Power Supply

DC 15V

Speaker

15W+15W

Weight

41KG

Dimensions

1365(W) x 330(D) x 790(H) mm

Voice List

NO.	English Name
1	Grand Piano
2	Grand Piano 2
3	Ele. Piano
4	Ele. Piano 2
5	Harpsichord
6	Clavichord
7	Music Box
8	Vibraphone
9	Marimba
10	Drawbar Organ

NO.	English Name
11	Percussive Organ
12	Church Organ
13	Church Organ 2
14	Reed Organ
15	Rock Organ
16	Accordion
17	Harmonica
18	Stereo Strings
19	Stereo Strings 2
20	Synth Strings

NO.	English Name
21	Choir Aahs
22	Sweet Trumpet
23	Soprano Sax
24	Tenor Sax
25	Pan flute
26	Strings

Song List

NO.	English Name
1	Waltz For Piano In g-Sharp Minor
2	The Happy Farmer
3	Etude
4	Dance Of The Four Swans From "Swan Lake"
5	Carmen Suite No.2 Habanera
6	A Little Polish Dance
7	Jesus Saviour Pilot Me
8	Old Macdonald Had A Farm
9	O Sole Mio
10	Wedding March From "Mendelssohn"
11	2-Part Invention No.13 In A Minor BWV 784
12	Turkish March
13	Italian Polka
14	Musette
15	Bourree
16	To A Wild Rose
17	Away In A Manger
18	Fur Elise
19	The Marriage Of Figaro
20	Angels We Have Heard On High
21	Waltz
22	America The Beautiful
23	Did You Ever See A Lassie
24	Arabesque
25	Old France
26	Santa Claus Is Coming To Town
27	Music Box Dancer
28	Symphony No.9 In e Minor Large From "The New World"
29	Larghetto
30	French Suite No. 5 in G Major, BWV 816 - IV. Gavotte
31	Mazurka

NO.	English Name
32	Minuet 1
33	Minuet 2
34	Minuet 3
35	Minuet In G
36	Neapolitan Song
37	Prelude In E Major
38	Salut D' Amour
39	Pizzicato Polka
40	Piano Sonata No.11 in A major K331 I. Andante grazioso
41	Innocence
42	Duke Aria From "The Rigoletto"
43	Burgmuller Op.100 No.15 - Ballade
44	Spinning Song
45	In The Theatre
46	Alfredo and Violetta Column Tower Duet
47	Come Back To Sorrento
48	Piano Sonatina In F Major
49	Tchaikovsky Waltz
50	Military March No.1 In D Major
51	Als Die Alte Mutter Mich Noch lehrte Singen
52	Etude on Leger Lines 1
53	Etude on Leger Lines 2
54	At the Ball
55	Dancing Raindrops
56	From a Story Book
57	Comin' 'Round the Mountain
58	Song of the Brook
59	Puck
60	Cotton-pickin' Fingers
DEMO	Fantasia

MIDI Implementation List chart

Function		Transmitted	Recognized	Remarks
Basic Channel	Default	1ch	ALL	
	Changed	1-16ch	1-16ch	
Mode	Default	x	3	
	Messages	x	3	
	Altered	*****	x	
Note Number	Note	0—127	0—127	
	:True voice	*****	0—127	
Velocity	Note on	o 9nH,V=1-127	o 9nH,V=1-127	
	Note off	x (9nH,V=0)	o(9nH,V=0; 8nH,V=0-127)	
After Touch	key's	x	x	
	Ch's	x	x	
Pitch Bend		x	o	
Control Change	0	o	o	Bank Select
	1	x	o	Modulation
	5	x	o	Portamento Time
	6	o	o	Data Entry
	7	o	o	Volume
	10	x	o	Pan
	11	x	o	Expression
	64	o	o	Sustain Pedal
	65	x	o	Portamento ON/OFF
	66	o	o	Sostenuto Pedal
	67	o	o	Soft Pedal
	80	x	o	Reverb Program
	81	x	o	Chorus Program
	91	o	o	Reverb Level
	93	o	o	Chorus Level
	120	x	o	All Sound Off
121	x	o	Reset All Controllers	
123	o	o	All Notes Off	
Program Change	:true	*****	0—127	
System Exclusive		x	o	
System Common	:SongPosition	x	x	
	:Song Select	x	x	
	:Tune	x	x	
System Real Time	:Clock	x	x	
	:Commands	x	x	
Aux Messages	:LOCAL ON/OFF	x	x	
	:All Notes Off	o	o	
	:Active sense	o	o	
	:Reset	x	o	

- Mode 1: OMNI ON, POLY
- Mode 2: OMNI ON, MONO

- Mode 3: OMNI OFF, POLY
- Mode 4: OMNI OFF, MONO

- o: YES
- x: NO