

# artesia

## DP-10e

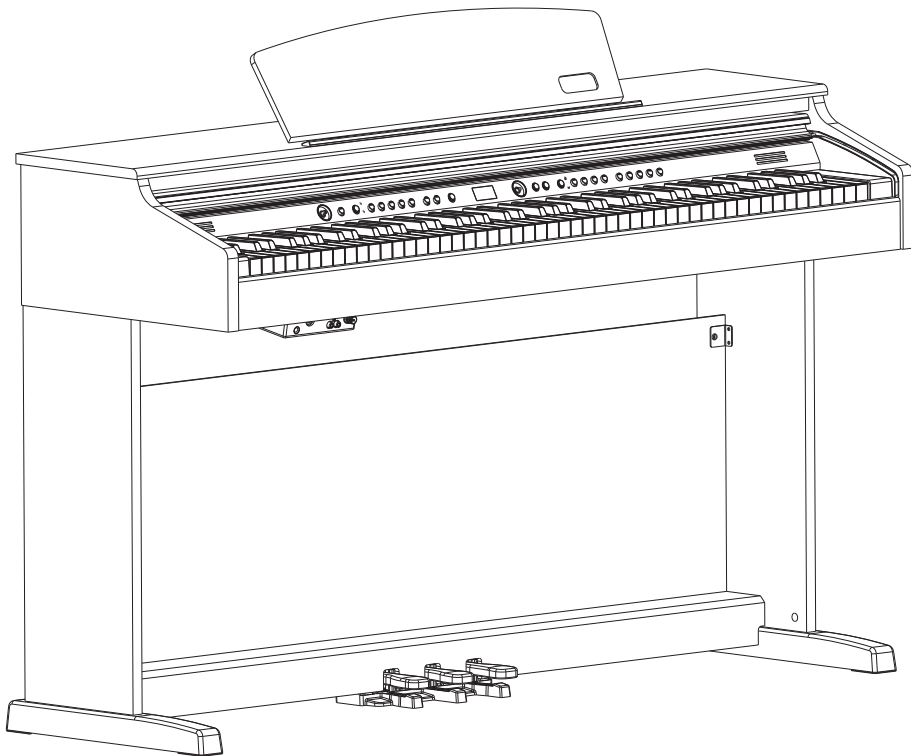

# Owner's Manual

Virgin Musical Instruments

## Precaution

Thank you for purchasing this digital instrument. For perfect operation and security, please read the manual carefully and keep it for future reference.

### Safety Precautions



The lightning with arrowhead symbol within an equilateral triangle is intended to alert the user to the risk of electrical shock within the product's enclosure that may cause injury.



The exclamation point within an equilateral triangle is intended to alert the user to follow the operating and maintenance instructions found in the literature accompanying the product.

### Important Safety Instructions

- 1) Read and follow these instructions.
- 2) Keep these instructions.
- 3) Heed all warnings.
- 4) Do not use this product near water.
- 5) Clean only with a dry cloth.
- 6) Do not block any ventilation openings; install in accordance with the manufacturer's instructions.
- 7) Do not install near any heat sources such as radiators, heat registers, stoves, or any other apparatus (including amplifiers) that produce heat.
- 8) Only power this product using a grounded electrical outlet.
- 9) Protect the power cord from being walked on or pinched particularly at plugs, convenience receptacles, and the point where they exit from the apparatus.
- 10) Only use official attachments/accessories specified by the manufacturer.
- 11) Use only with the cart, stand, tripod, bracket, or table specified by the manufacturer, or sold with the apparatus. When a cart is used, use caution when moving the cart/apparatus combination to avoid injury from tip-over (Figure 1).
- 12) Unplug this apparatus during lightning storms or when unused for a long periods of time.
- 13) Refer all servicing to qualified service personnel. Servicing is required when the apparatus has been damaged in any way, such as power-supply cord or plug is damaged, liquid has been spilled or objects have fallen into the apparatus, the apparatus has been exposed to rain or moisture, does not operate normally, or has been dropped.



(Figure 1)

**WARNING:** To reduce the risk of fire and electric shock do not expose this apparatus to rain or moisture.

**WARNING:** This product contains chemicals, including lead, known to the State of California to cause cancer, and/or birth defects or other reproductive harm. Wash hands after handling.

## **Thank you for choosing the Artesia DP-10e**

Your new piano is a high quality digital piano featuring an 88 note hammer action and touch sensitive keyboard. Plus the most advanced 3D sampling tone generation technology that together will provide you with a rich performing and playing experience. You can also record your own performances or record your own accompaniment to play along with. Your Piano is not only an excellent piano but is also a traditional piece of furniture that will look great in any home decor. To get the most out of your instrument, please read this manual and try out the various functions as you go. Additionally there are so many different exciting features and functions you can also access by plugging in your laptop, table or smartphone. Your new instrument contains the latest technology and is built to last and should continue to offer musical enjoyment of many years to come.

If you have any questions or comments regarding your new piano please call or email us, we would love to hear from you:

TOLL FREE PHONE 888-998-9848  
EMAIL [info@virginmusicalinstruments.com](mailto:info@virginmusicalinstruments.com)

Thank you for your Support:  
Virgin Musical Instrument Company Inc  
PO Box 2908  
La Mesa, CA 91943

# Contents

Panel Control .....	1
Setup .....	3
Basic Operation .....	4
The Connector Box .....	7
Voice/Effect .....	9
Set Up .....	14
Accompaniment .....	21
Song Recording .....	24
Learning Function .....	26
MIDI Function .....	28
Factory Reset .....	29
Appendix .....	30
Specifications .....	34
Warranty .....	35

# Panel Control

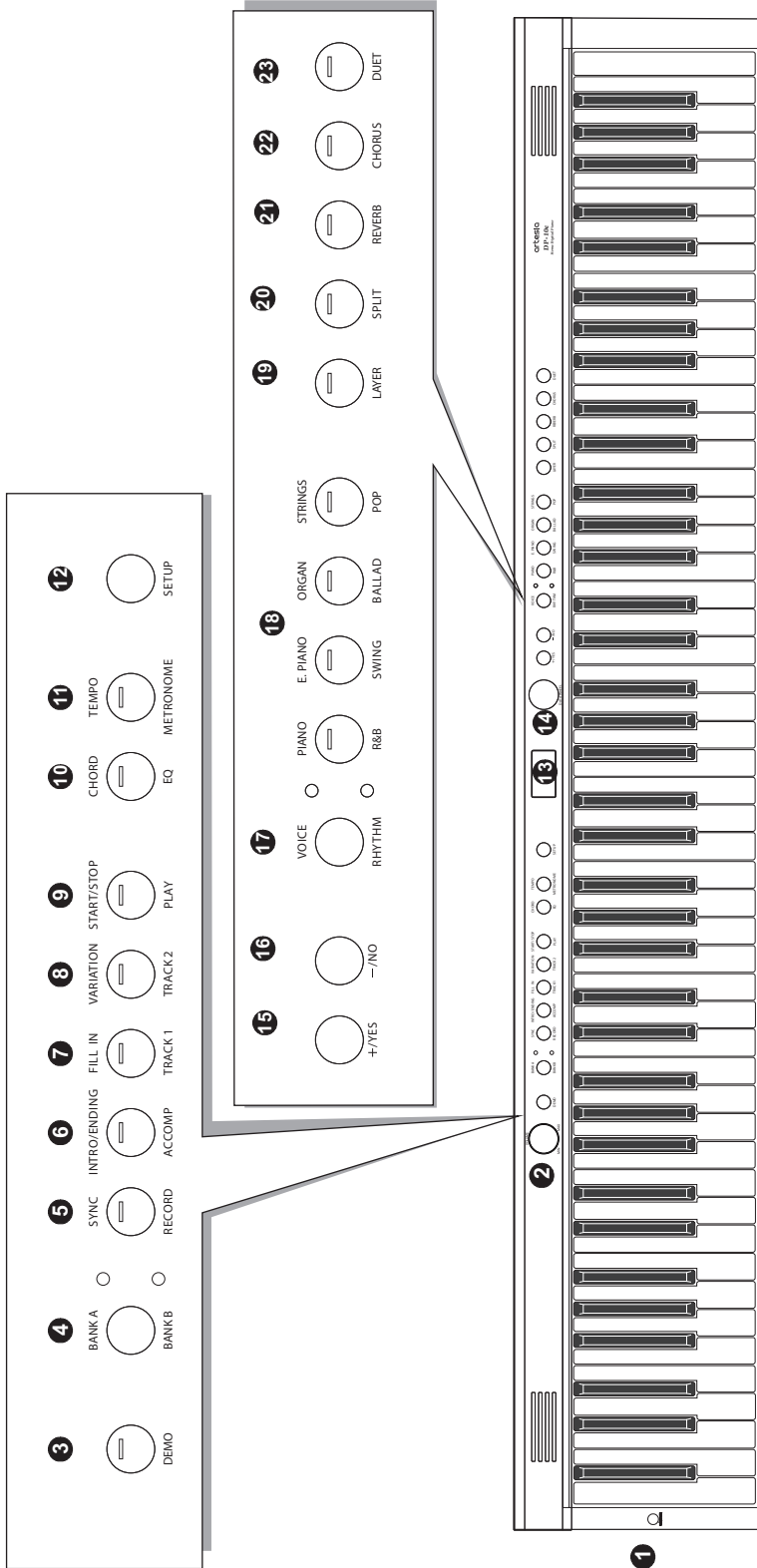

## Rear Panel

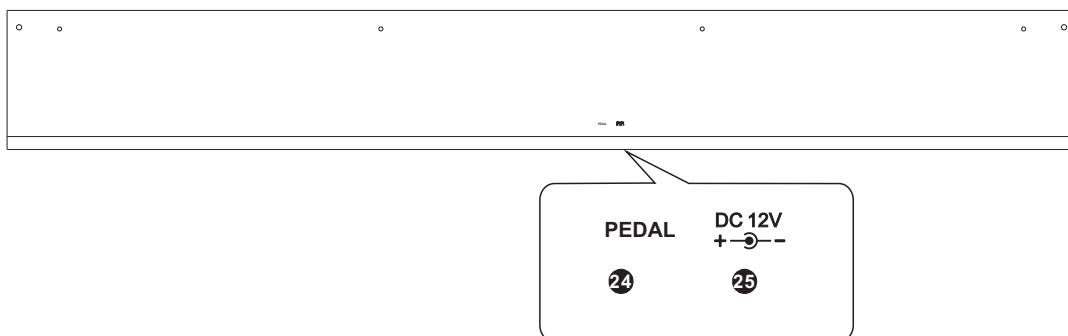

## Connections Panel

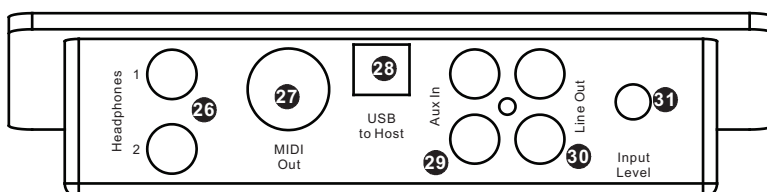

## Front Panel

1. STANDBY /ON button
2. VOLUME Data Control knob
3. DEMO button
4. BANK A / BANK B button
5. SYNC/RECORD button
6. INTRO/ENDING / ACCOMP button
7. FILLIN/TRACK 1 button
8. VARIATION/TRACK 2 button
9. START / STOP / PLAY button
10. CHORD/EQ button
11. TEMPO/METRONOME button
12. SETUP button
13. LCD display
14. DATA WHEEL knob button
15. +/YES button
16. -/NO button
17. VOICE/RHYTHM button
18. VOICE/RHYTHM select buttons

19. LAYER button
20. SPLIT button
21. REVERB button
22. CHORUS button
23. DUET button

## Rear Panel

24. Pedal Connector
25. Power Connector (DC 12V)

## Connections Panel

26. Headphones 1 / 2
27. MIDI Out
28. USB to Host Connector
29. Aux Line In
30. Line Out
31. Aux Input Level

# Setup

You are no doubt eager to play your new piano instrument, but first please make sure you have completed the following setup steps:

- 1) See the assembly guide
- 2) Once the piano is securely assembled, connect the plug of the foot pedal unit into the pedal jack located on the bottom rear panel.

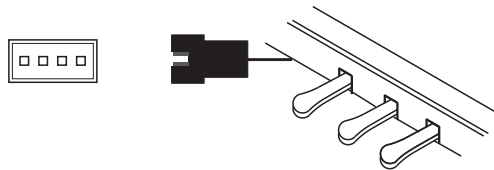

- 3) Plug the other end of the power cable into the power outlet.

## NOTE

1. Ensure the piano is turned off before connecting and disconnecting the power.
2. Turn the volume knob to its minimum level before turning on the power.

# Basic Operation

## Standby/On

Press the [STANDBY/ON] button to turn on the power and the LCD display will illuminate.

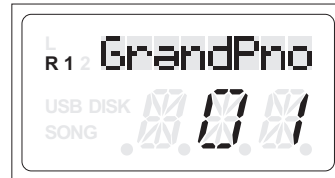

## Auto Standby

Your piano will switch off automatically after 30 minutes of inactivity. In this case, press the [STANDBY/ON] button to turn on the power.

## Deactivate Auto Standby Function

To deactivate the Auto Power Standby Function: hold the first white key and first black key from the left side of the keyboard at the same time and then press the [STANDBY/ON] button.

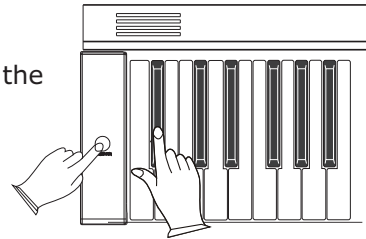

## Adjusting Volume & Starting to Play

The speaker system in your piano is very powerful and can be overpowering in some rooms. Adjust the [VOLUME] control to a 12 o'clock position as a safe starting point. You can adjust the volume at any time even while you are playing.

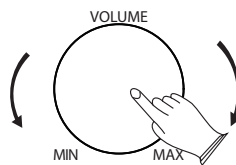

Now play the keyboard. You should hear the rich tone of the default Grand Piano sound.

## Piano Pedals

Just like a regular grand piano, your piano features 3 foot pedals:

### **Damper Pedal (Right)**

The damper pedal performs the same function as the damper pedal on an actual acoustic piano, letting you sustain the sound of the notes being played after releasing your fingers from the keys.

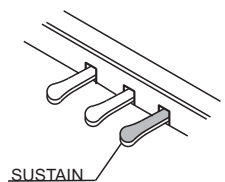



### **Sostenuto Pedal (Center)**

The sostenuto pedal also allows you to sustain notes, but it works a little different than the damper pedal. If you play a note or chord on the keyboard and press the sostenuto pedal while the notes are held, those notes will be sustained as long as the pedal is held. All subsequently played notes will not be sustained.

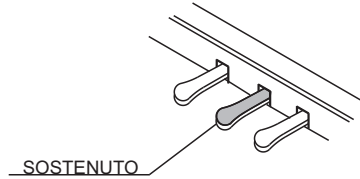

### **Soft Pedal (Left)**

The soft pedal on an acoustic piano changes the character of the sound, making it softer and quieter. The soft pedal on your piano does exactly the same. Press the soft pedal when you need to play passages that require extreme pianissimo.

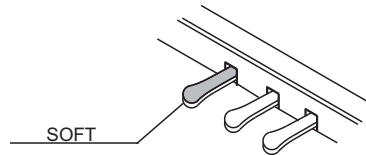

## **Playing Demo Songs**

There are 10 demo songs for you to play individually. Here's how to select and play the demo songs.

### **■ Listen to the Demo Songs**

Press the [DEMO] button to enter the Demo Mode.

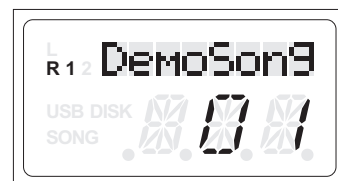
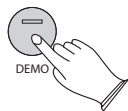

The display will show “DemoSong,” after 5 seconds then the demo songs will play in sequence. You can use the [+ / YES] / [- / NO] buttons or [DATA WHEEL] knob to select the song you want to play.

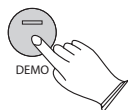

Press the [DEMO] button again to stop playing the Demo Song.

### **[+ / YES] & [- / NO]**

These buttons are used to adjust or select the parameters of specific functions.

# The Connector Box

## Headphones

This piano is equipped with two sets of standard stereo headphone jacks to accommodate private practice or late-night playing. The internal speaker system is automatically shut off when a pair of headphones is plugged into the 1. Headphone jack.

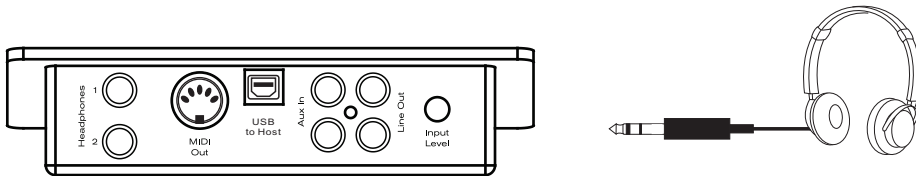

## MIDI Out

MIDI (Musical Instrument Digital Interface) is a world-standard communication interface which allows electronic musical instruments to communicate with each other, by sending and receiving compatible notes, program changes and other types of MIDI data. You should only plug the MIDI out in to another device featuring a MIDI input.

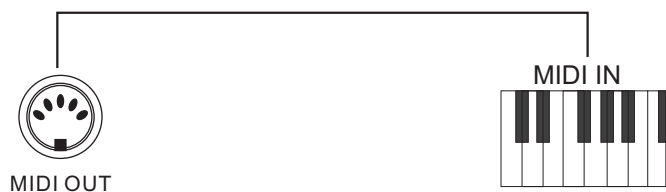

### NOTE

The MIDI OUT jack transmits MIDI data to another MIDI device.

## Line Out

The piano's stereo RCA line output can be used to deliver the output of the piano to a keyboard amplifier, stereo sound system, mixing console or powered speaker monitors. The piano's internal sound system will remain on unless headphones are plugged in to the #1. Headphone jack.

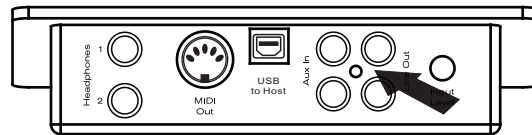

## Using USB-MIDI/USB Audio

This product allows the transfer of MIDI information over USB to a laptop, tablet or smartphone. As complicated as this might sound, it's actually pretty straight forward. This piano is USB Class Compliant; therefore there is no need to install a driver to enable it to work with a computer. Simply just plug it in and the computer's operating system will do the rest. The piano will work with all standard MIDI based computer software.

USB AUDIO interface is a digital audio interface. By USB cable, you can digitally transfer intact audio signals from a Laptop, Tablet or Smartphone to this instrument, and enjoy it on this instrument or use it for accompaniment when you play this instrument; likewise, you can transfer intact audio signals of the instrument to Laptop's, Tablet's or Smartphone's to record and edit music.

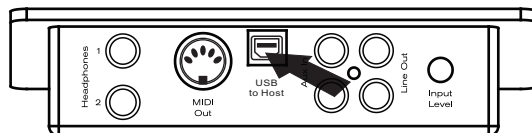

## Aux In

The Aux In stereo RCA connectors allow you to play an external sound source (such as a Laptop, Tablet or Smartphone output) through the piano's built-in speakers or headphone outputs.

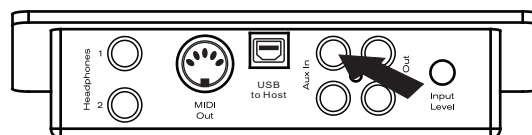

The Aux In signal level can be adjusted using the Input Level knob.

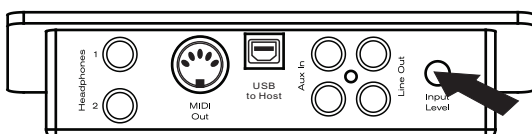

## Voice/Effect

This piano has 137 voices. See page 31 for a complete list of all voices.

### Selecting a Voice

When the upper LED indicator of the [VOICE/RHYTHM] button is lit, you can select the desired voice by pressing the appropriate VOICE button.

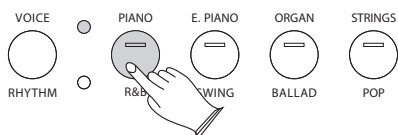

The DP-10e has 4 direct-selecting voice buttons.

When pressing a voice button, the assigned voice number is shown on the display and the button will light.

You can change the instrument voice by pressing one of the other instrument voice buttons or use the [+ / YES] / [- / NO] button or turn the [DATA WHEEL] to select the desired voice.

### Layer Button

In Layer mode two voices may be played simultaneously, each at selected volumes. Press the [LAYER] button and when the indicator LED is flashing press a voice button to select the second voice.

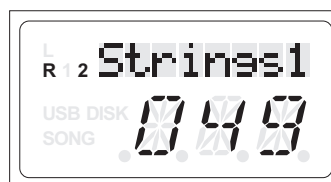
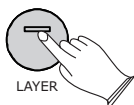

If you do not choose the layer voice within 5 seconds after entering the Layer mode, it will quit this menu selection automatically.

If the Layer indicator is not flashing, then pressing a voice select button will change the primary voice.

- **Set Layer Voice Volume**

Reference: Dual Voice Volume(P.17).

- **Exit Layer Voice mode**

To turn off layer mode: press the [LAYER] button again.

## Split Button

Press the [SPLIT] button to activate the split mode, your keyboard will be split into two sections that play different voices on the left and right sides of the keyboard. To activate the Split mode: press the [SPLIT] button, then when the Split indicator will flash, next press a voice select button to select the left voice.

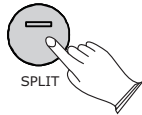

If you do not choose the left voice within 5 seconds after entering the split mode, it will quit this menu selection automatically.

When the Split indicator is not flashing, then pressing a voice select button will change the primary voice.

To turn off split mode: press the [SPLIT] button again.

### ● Adjusting Split Voice Volume

Reference : Split Voice Volume(P.17).

### ● Changing the Split Point

The Split Point is where the Left and Right part of the keyboard have different instrument voices. When you exit the split mode, hold down the [SPLIT] button, the indicator will flash, you can play any one of the keys to set the split point value:1-88 Keys. (Default:35 Key).

## Reverb

The [REVERB] button selects a number of digital reverb effects that you can use for extra depth and expressive power.

Pressing the [REVERB] button will turn on or turn off the reverb effect.

The default reverb type is “room 3” .

When the reverb mode is turned on, you can use the [+ /YES] and [- /NO] buttons or [DATA WHEEL] knob to select a different reverb type.

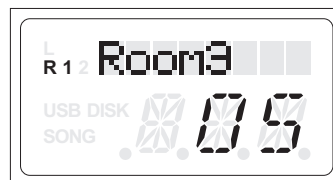
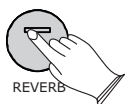

The reverb types in the list below can be selected from the reverb display.

00	01	02	03	04	05	06	07	08
Off	Hall1	Hall2	Room1	Room2	Room3	Stage 1	Stage2	Plate

To change the reverb level: see page 15.

## Chorus

Shimmering, broadening effect that is added to your selected instrument voice.

Press the [CHORUS] button can turn on or turn off the chorus effect.(Default:00)

When the chorus mode is turned on, you can press the or[+/YES] and [-/NO] buttons use the [DATA WHEEL] knob to select chorus type.



The chorus types in the list below can be selected from the chorus display.

00	01	02	03	04	05	06	07	08
off	Chorus1	Chorus2	Chorus3	Chorus4	Feedback	Flanger1	ShortDelay	ShortDe- layFb
9	10	11	12	13				
Flanger2	Flanger3	Celeste1	Celeste 2	Celeste 3				

To change the Chorus Level see page 16.

## DUET

Press the [DUET] button to select DUET mode. In this mode, the keyboard will be split into two separate playing areas for teacher and student.

Right: from C#3 to C7

Left: from A-1 to C3

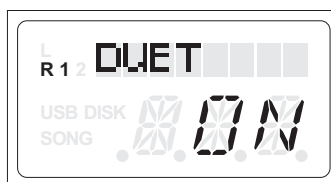
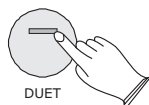

This will be very helpful when the instrument is used by two players at the same time as they will be able to play the same piano sound in the same octave.

Press [DUET] button again to exit the DUET mode.

While the DUET feature is selected using the optional 3 lever pedal, the pedals automatically switch in a different configuration where there are 2 Sustain pedals, one for the left and one for the right part of the keyboard.

## Metronome

Metronome is a convenient feature for practice, and it provides a solid rhythmic guide when recording.

When the lower indicator of the [BANK A/BANK B] button is lit, press the [METRONOME] button to turn the metronome off or on.

### ● Time signature

While holding down the [METRONOME] button use the [+ / YES] and [- / NO] buttons or [DATA WHEEL] to change the time signature of the metronome.

Time signatures: 2/2, 1/4, 2/4, 3/4, 4/4, 5/4, 6/4, 3/8, 6/8, 7/8, 9/8, 12/8.

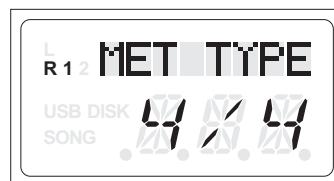
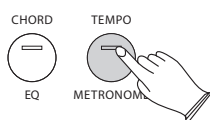

### ● Adjusting the Metronome Tempo

This function allows you to set the rhythm tempo.

When the upper indicator of the [BANK A/BANK B] button is lit, press the [TEMPO] button to set Tempo value.

Use the [+ / YES] / [- / NO] button or the [DATA WHEEL] knob to change the tempo value range from 20 to 280 BPM (beats per minute).

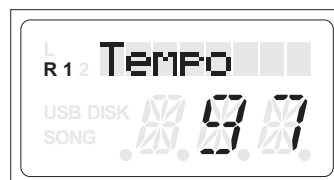
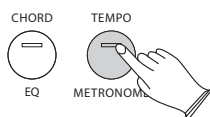
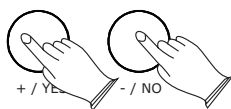

## Touch

It adjusted the piano keys touch sensitivity levels.  
Reference: Touch P.18.



## EQ

When the lower indicator of the [BANK A/BANK B] button is lit, press the [EQ] button repeatedly to select the EQ Bass or EQ Treble function.

Press the [CHORD/EQ] button repeatedly to select the EQ Bass, then press the [+ / YES] and [- / NO] buttons or [DATA WHEEL] to set the value: -12~12. (Default: 00).

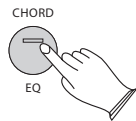

Press the [CHORD/EQ] button repeatedly to select the EQ treble, then press the [+ / YES] and [- / NO] buttons or [DATA WHEEL] to set the value: -12~12. (Default: 00).

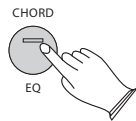

# Set Up

Press the [SET UP] button repeatedly or turn the [DATA WHEEL] to select the function that you desire, see the table below:

Function	LCD Display	Range	Default
Reverb Type	REVERB	00-08	05
Chorus Type	CHORUS	00-13	00
Reverb Level	REV LVL	00-63	18
Chorus Level	CHR LVL	00-63	18
Metronome Type	MET TYPE	2/2-8/12	4/4
Metronome Volume	MET VOL	00-127	100
Main Voice Volume	MAIN VOL	00-127	115
Split Voice Volume	SPLITVOL	00-127	100
Layer Voice Volume	LAY VOL	00-127	75
Accompaniment Volume	ACC VOL	00-31	19
Touch Sensitivity	TOUCH	00-06	02
Tune	TUNE	-64-63	00
Transpose	TRANSPOS	-12-12	00
Song Grading	GRADING	On/Off	ON
Local	LOCAL	On/Off	ON
Reset	RESET		

## ● Reverb Type

Press the [SETUP] button repeatedly or turn the [DATA WHEEL] to select "REVERB", then press the [+ / Yes] button to confirm the selection, then use the [+ / Yes] and [- / No] buttons or [DATA WHEEL] knob to select the desired Reverb Type.

Range: 00 - 08. (Default: 05)

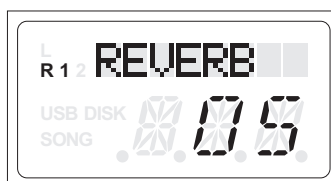

No reverb effect is produced when you select the reverb type "00".

## ● Chorus Type

Press the [SETUP] button repeatedly or turn the [DATA WHEEL] to select "CHORUS", then press the [+ / Yes] button to confirm the selection, then use the [+ / Yes] and [- / No] buttons or [DATA WHEEL] knob to select the desired Chorus Type.

Range: 00-13. (Default: 00)

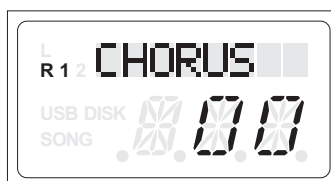

No chorus is produced when you select the chorus type "00".

## ● Reverb Level

This function allows you to adjust the reverb depth for the voice section.

Press the [SETUP] button repeatedly or turn the [DATA WHEEL] to select "REV LVL", then press the [+ / Yes] button to confirm the selection, then use the [+ / Yes] and [- / No] buttons or [DATA WHEEL] knob to adjust the value. Range: 00 - 63. (Default: 18)



## ● Chorus Level

This function allows you to adjust the chorus depth for the voice section.

Press the [SETUP] button repeatedly or turn the [DATA WHEEL] to select "CHR LVL", then press the [+ / Yes] button to confirm the selection, then use the [+ / Yes] and [- / No] buttons or [DATA WHEEL] to adjust the value. Range: 00 - 63.  
(Default:18)

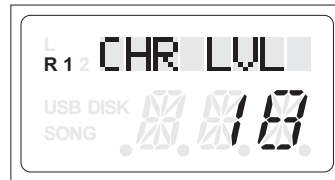
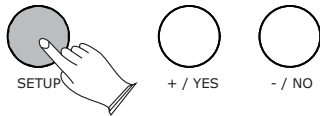

## ● Metronome Type

In this function you can set the time signature of the metronome.

Press the [SETUP] button repeatedly or turn the [DATA WHEEL] to select "MET TYPE", then press the [+ / Yes] button to confirm the selection, then use the [+ / Yes] and [- / No] buttons or [DATA WHEEL] to adjust the value. Time signatures: 2/2, 1/4, 2/4, 3/4, 4/4, 5/4, 6/4, 3/8, 6/8, 7/8, 9/8, 12/8.  
(Default:4/4)

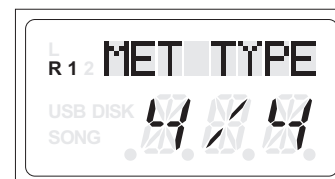
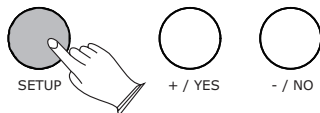

## ● Metronome Volume

In this function you can set the Metronome Volume.

Press the [SETUP] button repeatedly to select "MET VOL", then press the [+ / Yes] button to confirm the selection, then use the [+ / Yes] and [- / No] buttons or [DATA WHEEL] to increase or decrease the value. Range: 00 - 127. (Default:100)

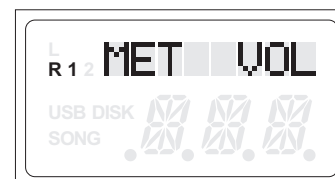
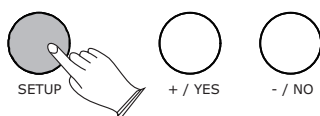

## ● Main Voice Volume

In this function you can set the Main Voice Volume.

Press the [SETUP] button repeatedly or turn the [DATA WHEEL] to select "MAIN VOL", then press the [+ / Yes] button to confirm the selection, then use the [+ / Yes] and [- / No] buttons or [DATA WHEEL] to increase or decrease the value.

Range: 00 - 127. (Default: 115)

Please note that if you increase the Main Volume level slight distortion may occur.

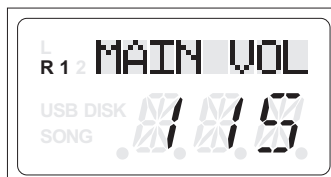
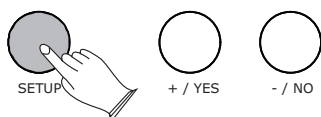

## ● Split Voice Volume

In this function you can the split voice volume.

Press the [SETUP] button repeatedly or turn the [DATA WHEEL] to select "SPLIT VOL", then press the [+ / Yes] button to confirm the selection, then use the [+ / Yes] and [- / No] buttons or [DATA WHEEL] to increase or decrease the value. Range: 00 - 127. (Default: 100)

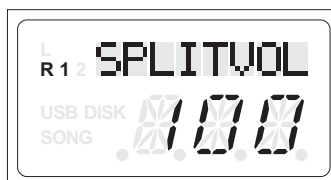
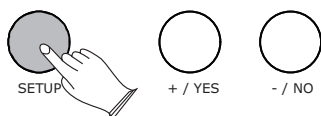

## ● Layer Voice Volume

In this function you can set the Layer Voice Volume.

Press the [SETUP] button repeatedly or turn the [DATA WHEEL] to select "LAY VOL", then press the [+ / Yes] button to confirm the selection, then use the [+ / Yes] and [- / No] buttons or [DATA WHEEL] increase or decrease the value. Range: 00 - 127. (Default: 75)

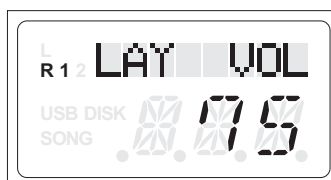
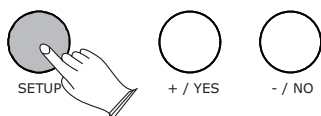

## ● Acc.Vol

This function makes it possible to raise or lower the Accompaniment Volume of your piano.

Press the [SETUP] button repeatedly or turn the [DATA WHEEL] to select "ACC VOL", then press the [+ / Yes] button to confirm the selection, then use the [+ / Yes] and [- / No] buttons or [DATA WHEEL] to adjust the value. Range: 00-31.  
(Default: 19)

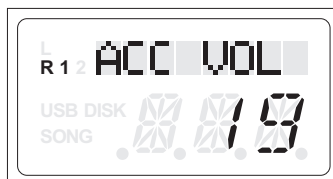
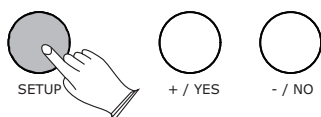

## ● Touch

This function makes it possible to raise or lower the Touch Sensitivity of your piano.

Press the [SETUP] button repeatedly or turn the [DATA WHEEL] to select "TOUCH", then press the [+ / Yes] button to confirm the selection, then use the [+ / Yes] and [- / No] buttons or [DATA WHEEL] knob to adjust the value. 1 TOUCH LO, 2 TOUCH NOR, 3 TOUCH HI, 4 TCH2 LOW, 5 TCH2 NOR, 6 TCH2 HI. (Default: 2).

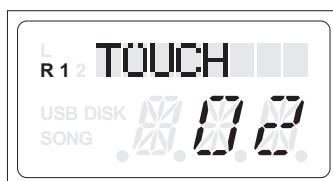
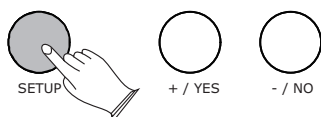

## ● Tune

This function makes it possible to raise or lower the pitch of your piano.

Press the [SETUP] button repeatedly or turn the [DATA WHEEL] to select "TUNE", then press the [+ / Yes] button to confirm the selection, then use the [+ / Yes] and [- / No] buttons or [DATA WHEEL] to set the value. Range: -64 - 63. (Default: 00)

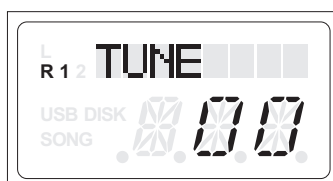

## ● Transpose

The Transpose function allows you to change the pitch of the piano in semitone steps, up to a maximum setting of 12 semitones (one octave).

Press the [SETUP] button repeatedly or turn the [DATA WHEEL] to select "TRANSPOS", then press the [+ / Yes] button to confirm the selection, then use the [+ / Yes] and [- / No] buttons or [DATA WHEEL] knob to adjust the value.

Range: -12 - 12. (Default: 00)



## ● Song Grading

This function is in the song learning mode, when playing songs, it will automatically score based on your performance.

Press the [SETUP] button repeatedly or turn the [DATA WHEEL] to select "GRADING", then press the [+ / Yes] button to confirm the selection, then use the [+ / Yes] and [- / No] buttons or [DATA WHEEL] knob to turn the function on or off. (Default: On)

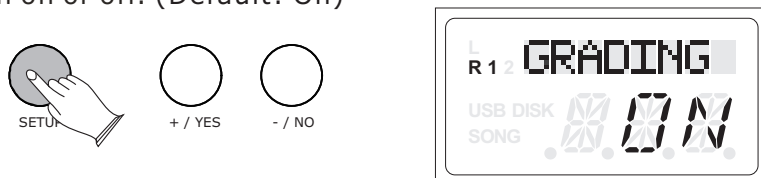

## ● Local

Using this function, you can turn off the keyboard's internal sound generator, while still sending MIDI data.

Press the [SETUP] button repeatedly or turn the [DATA WHEEL] to select "LOCAL", then press the [+ / Yes] button to confirm the selection, then use the [+ / Yes] and [- / No] buttons or [DATA WHEEL] knob to turn the function on or off. (Default: On)

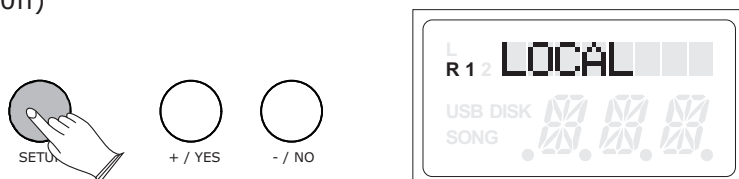

Local on----- Normal operation. Keyboard and Controllers are sent to the Sound Engine. Keyboard plays normally.

Local off----- There will be no sound produced by the keyboards own tone generation system. MIDI function will continue to work as usual.

## ● Reset

Press the [SETUP] button repeatedly or turn the [DATA WHEEL] to select "RESET", then press the [+ / Yes] button to confirm and then the piano will reset. When engaged the pianos settings will return its factory default settings.

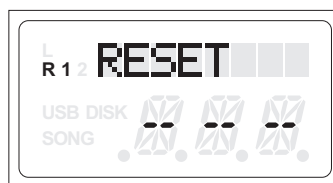
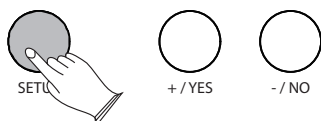



# Accompaniment

Your piano has 100 accompaniment styles which can be used to provide Fully-orchestrated Auto Accompaniment. When the Auto Accompaniment function is turned on, your piano will create fully-orchestrated rhythm, bass and chord accompaniment based on chords you play with the left hand in the Auto Accompaniment section of the keyboard (i.e. all keys to the left of the Auto Accompaniment split point). The right-hand section of the keyboard is available for normal playing.

The default Auto Accompaniment split point is the F#2 key. The Auto Accompaniment section of the keyboard consists of all keys to its left.

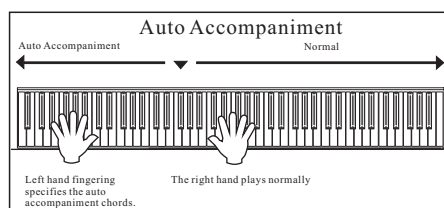

## Using Auto Accompaniment (Only Rhythm Track)

### Select a Rhythm Style

When the lower indicator of the [VOICE/RHYTHM] button is lit, then you can select the desired voice by pressing the appropriate STYLE button.

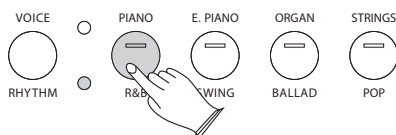

The digital piano has 4 direct-selecting style buttons.

When pressing a style button, the assigned style number is shown on the display and the button will light.

You can change the instrument style by pressing one of the other instrument voice buttons or turn the [DATA WHEEL] to select the desired style.

### Start a Rhythm Style

When the upper indicator of the [BANK A/BANK B] button is lit, press the [START/STOP/PLAY] button to start a Rhythm style.

### Stop a Rhythm Style

When the upper indicator of the [BANK A/BANK B] button is lit, press the [START/STOP/PLAY] button again to stop a Rhythm style.

## Using Auto Accompaniment

When the upper indicator of the [BANK A/BANK B] button is lit.

### Select a Rhythm Style

Reference: Select a Rhythm style .(P.21)  
See list of Rhythm Styles on page 32

### Turn On the Chord Function

Reference: "Chord Button " function.(P.23).

The left hand section of the keyboard becomes the Auto Accompaniment section, and chords played in this section are automatically detected and used as a basis for fully automatic accompaniment with the selected Rhythm style.

### Turn On the Synchro Start Function

Press the [SYNC] button. The beat lamp will flash with the tempo and it's called synchronized start standby. The auto accompaniment will start as soon as you play a chord with your left hand.

### Stop Playing the auto accompaniment

Press the [START/STOP/PLAY] button again to stop the auto accompaniment. An accompaniment progress can be stopped immediately by pressing the [START/STOP/PLAY] button and also can be stopped with an appropriate ending by pressing the [INTRO/ENDING/ACCOMP] button.

### Starting with an Intro

All your piano accompaniment patterns can be started with an appropriate introduction by pressing the [INTRO/ENDING/ACCOMP] button directly.

If you press the [SYNC/RECORD] button and then press the [INTRO/ENDING/ACCOMP] button, the accompaniment will start from the introduction as soon as a chord is detected in the AUTO ACCOMPANIMENT section of the keyboard.

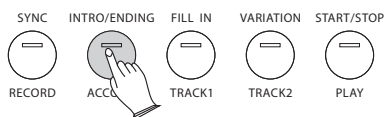

## Fill-In

Press the [FILL IN /TRACK 1] button at any time while the accompaniment is playing to add a rhythmic fill-in pattern.

If you press the [SYNC/RECORD] button and then the [FILL IN/TRACK 1] button, the accompaniment will start from the fill-in as soon as a chord is detected in the AUTO ACCOMPANIMENT section of the keyboard.

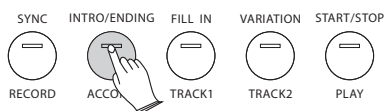

## Chord Button

When the upper indicator of the [BANK A/BANK B] button is lighted, press the [CHORD/EQ] button to turn on the function.

Press the [CHORD/EQ] button to turn the chord function on. The left hand section of the keyboard becomes the Auto Accompaniment section, and chords played in this section are automatically detected and used as a basis for fully automatic accompaniment with the selected Rhythm style.

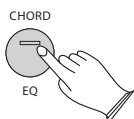

### • Changing the Chord Point Split Location

When you exit the chord mode, hold down the [CHORD] button, the indicator will flash, you can play any one of the keys to set the chord point value:1-88. (Default:35).

## Variation Button

All of the 100 rhythm styles include a variation of that rhythm style that can be played simply by engaging the [VARIATION/TRACK 2] button. Press the [VARIATION/TRACK 2] button again to disengage and return to the main pattern.

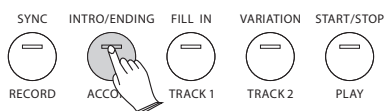

# Song Recording

The recording function lets you record your performances using up to two independent tracks. The recorded data will not be lost when you turn off the piano.

## Start Recording

When the lower indicator of the [BANK A/BANK B] button is lit.

Hold down the [SYNC/RECORD] button, and then press the [INTRO/ENDING/ACCOMP], [FILL IN/TRACK 1] or [VARIATION/TRACK 2] button to enter recording mode, the [SYNC/RECORD] button indicator will light up, and [INTRO/ENDING/ACCOMP], [FILL IN/TRACK 1] or [VARIATION/TRACK 2] button indicator will flash. The recording starts as soon as you start playing the keyboard.

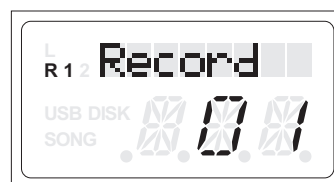
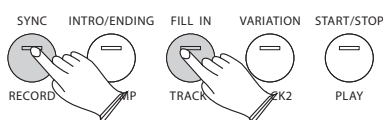

## Stop Recording

Press the [SYNC/RECORD] button again to stop recording.

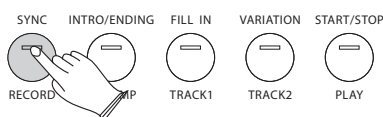

### NOTE

If the other track has data recorded, it will play when recording. You can mute the other track by pressing its track button. The [INTRO/ENDING/ACCOMP] track can record the auto accompaniment style.

## Listen to Your Recording

To play your recorded song from the beginning, simply press the [START/STOP/PLAY] button. Playback stops when the [START/STOP/PLAY] button is pressed again.

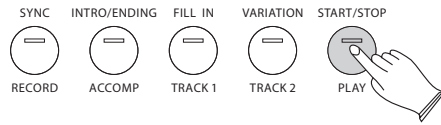

## Tack Clear

When the lower indicator of the [BANK A/BANK B] button is lit. Hold down the [SYNC/RECORD] button and then press [START/STOP/PLAY] button to clear all recorded data.

Hold down the corresponding button to delete the recorded track data.

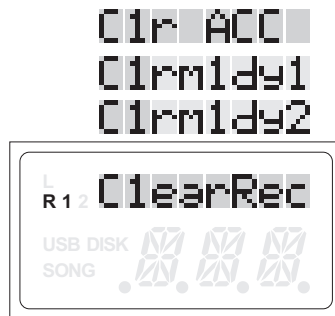
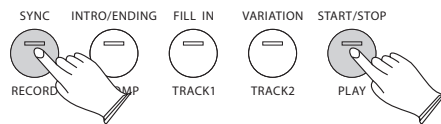

# Learning Function

There are many play along songs built into this Piano for your practice enjoyment. These songs have separate left and right-hand parts that can be turned on and off as required so you can practice the corresponding part on the piano.

## Selecting A Song

Press the [DEMO] button, then press the [+ / YES] / [- / NO] button or [DATA WHEEL] to select Bank. The song bank will appear on the LCD display.

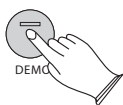

There are 6 song banks in the piano: Learn ( includes 55 songs),Beyer (includes 106 songs),Czerny 100( includes 100 songs),Czerny 30 (includes 30 songs),Czerny 40( includes 40 songs),Sonatine( includes 45 songs).

In the song mode, press the [+ / YES] and [- / NO] buttons or the [DATA WHEEL] knob to select the song bank, after 5 seconds, then you can use the [+ / YES] and [- / NO] buttons or the [DATA WHEEL] knob to select the desired song. Press the [START/STOP/PLAY] button to start the song.

## Listening To The Entire Song

- 1). With the play along song mode engaged, press the [START/STOP/PLAY] button to hear both hand parts playing the entire song.
- 2). Press the [START/STOP/PLAY] button again to stop. Otherwise, playback will stop automatically at the end of the song.

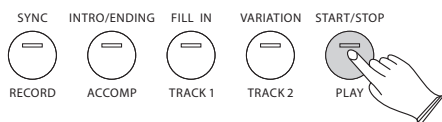

## Practicing The Right Hand Of The Selected Song

1). Press the [VARIATION/TRACK2] button to mute the right hand part of the song.

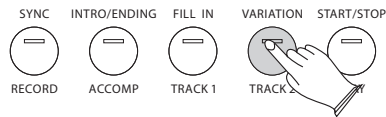

2). Press the [START/STOP/PLAY] button to start the song without the right hand part.

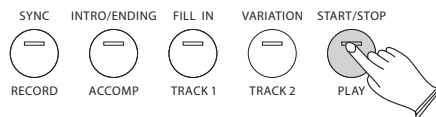

3). Play the right-hand part of your selected song and simultaneously you will hear the left-hand part play.

4). Press the [START/STOP/PLAY] button again to stop. Otherwise, playback will stop automatically at the end of the song.

## Practicing The Left Hand Of The Selected Song

Follow steps 1-4 listed above, substituting the [FILL IN/TRACK1] button whenever the [VARIATION/TRACK2] button is mentioned. You will hear the right-hand part of your selected song.

Play the left-hand part of your selected song while the right-hand part plays.

## Turn off the Learning Function

Press the [DEMO] button again to turn off the learning mode.

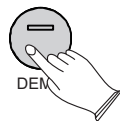

### NOTE

If the Song Grading is turned on, after you finish learning one song, your piano may automatically score 0~100 on your performance.

# MIDI Function

If you are an advanced MIDI user, this section will help you to access the MIDI controller capabilities of the piano. If you already know that you need this specialized functionality, then this section is for you. However, this information is not necessary in order to enjoy playing the piano.

MIDI, or Musical Instrument Digital Interface, is the way most electronic keyboards communicate with computers and with each other. Through a series of MIDI messages a computer or keyboard can tell an instrument what note to play, how loud to play it, when to stop playing it, and a host of other information.

The piano can send MIDI information to a computer or another MIDI-capable instrument, via its MIDI or USB output. This enables the piano to act as a controller keyboard for another instrument, MIDI sequencer or MIDI enabled Digital Audio Workstation program.

## Local On/Off

Turning the Local On/Off function to Off will disconnect the keyboard from the internal sound engine of the piano. This means you can use the piano as a MIDI controller to control other MIDI devices (or virtual instrument software running on your computer) without playing the internal sounds of the piano.

You may also find other occasions (such as when you are using MIDI sequencing software on your computer) where it is useful to turn Local off.

### Turn Local On/Off to Off

Please refer to [SETUP] function, see page 19.



# Factory Reset

Press the [SETUP] button repeatedly or turn the [DATA WHEEL] to select "RESET", then press the [+ / Yes] button to confirm and then the piano will reset.

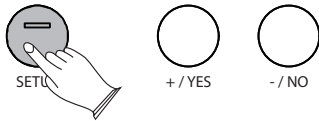

Hold down the [+ / YES] and [- / NO] buttons and press the [STANDBY / ON] button to turn on the piano, then your piano will be set back to factory defaults.

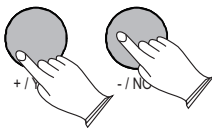

# Appendix

## MIDI Implementation Chart

Function		Transmitted	Recognized	Remarks
<b>Basic Channel</b>	Default	1-16	1-16	
	Changed	1-16	1-16	
<b>Mode</b>	Default	Mode 3	Mode 3	
	Messages	O	X	
	Altered	*****	X	
<b>Note Number</b>	True voice	0~127 *****	0~127	
<b>Velocity</b>	ON	O	O	
<b>Note</b>	OFF	O	O	
<b>After Touch</b>	Key's	X	X	
<b>Touch</b>	Touch Channel	X	X	
<b>Pitch Bend</b>		X	X	
<b>Control Change</b>		0-127	0, 1, 5, 6, 7, 10, 11, 32, 64, 65, 66, 67, 80, 81, 91, 93, 100, 101, 121	
<b>Program Change</b>	True #	0-127 *****	0-7	*8 sounds only PGM=0-7
<b>System Exclusive</b>		O*	O*	*The controller will recognize and respond to GM Device inquiries. Master Tune supported. Master Volume supported.
<b>System Common</b>	Song Position Pointer	X	X	
	Song Select	X	X	
	Tune Request	X	X	
<b>System Real Time</b>	Clock	X	X	
	Commands	X	X	
<b>Aux Messages</b>	All Sounds Off*	O	O	
	Reset All Controllers	O	O	
	Local ON/OFF*	O	O	
	ALL Notes OFF	O	O	
	Active Sensing	X	O	
	System Reset	X	O	
<b>Notes</b>				

Mode1: OMNI ON, POLY    Mode2: OMNI ON, MONO    O: Yes  
 Mode3: OMNI OFF, POLY    Mode4: OMNI OFF, MONO    X: NO





## Troubleshooting Hints

<ul style="list-style-type: none"> <li>•When the instrument is turned on or off, a popping sound is temporarily produced.</li> </ul>	<p>This is normal and indicates that the instrument is receiving electrical power.</p>
<ul style="list-style-type: none"> <li>•When using a mobile phone, noise is produced. Using a mobile phone in close proximity to the instrument may produce interference.</li> </ul>	<p>To prevent this, turn off the mobile phone or use it further away from the instrument.</p>
<ul style="list-style-type: none"> <li>•Not all of the voices seem to sound, or the sound seems to cut off.</li> </ul>	<p>The instrument is polyphonic up to a maximum of 128 notes — including Dual voice, Split Voice, auto accompaniment, song, and Metronome. Notes exceeding this limit will not sound.</p>
<ul style="list-style-type: none"> <li>•The Auto Accompaniment does not sound properly.</li> </ul>	<p>Make sure that the Auto Accomp Volume Function is set to an appropriate level. Is the Split Point set to an appropriate key for the chords you are playing? Set the Split Point to an appropriate position on the keyboard. Is the chord indicator showing in the LCD display? If it is not showing, press the CHORD button so that it does display properly..</p>
<ul style="list-style-type: none"> <li>•No sound produced by the keyboard, but the lights and screen work.</li> </ul>	<p>Check that the master volume control is not set to minimum. Check that nothing is plugged into the headphone socket.</p>
<ul style="list-style-type: none"> <li>•The sound of the voice changes from note to note.</li> </ul>	<p>This is normal. The digital tone generation uses multiple recordings (samples) of an instrument across the range of the keyboard; The actual sound of the voice may be slightly different from note to note.</p>
<ul style="list-style-type: none"> <li>•The volume is too soft.</li> <li>•The sound quality is poor.</li> <li>•The rhythm stops unexpectedly or will not play.</li> <li>•The recorded data of the song, etc. does not play correctly.</li> <li>•The LCD display suddenly goes dark, and all panel settings are reset.</li> </ul>	<p>Check your AC adapter. If you have lost or damaged your AC adaptor, please contact your nearest store for a correct replacement adapter. An incorrect AC mains adaptor which is not rated sufficiently can cause malfunction or damage.</p>
<ul style="list-style-type: none"> <li>•To completely restore all settings as per factory settings</li> </ul>	<p>Perform a factory reset, Please refer to content in this owner's manual. All of the user setting will be erased and the default factory settings will be applied to the instrument.</p>
<ul style="list-style-type: none"> <li>•Power suddenly and unexpectedly turns off, after a period of not touching the keys.</li> </ul>	<p>This is normal and the Auto Power Off function may have been activated. If you need to disable the Auto Power Off function, please see how to do this in the owner's manual.</p>
<ul style="list-style-type: none"> <li>•The sustain pedal seems to produce the opposite effect. Example pressing the footswitch deactivates the sustain, and releasing the footswitch triggers the sustain.</li> </ul>	<p>The polarity of the footswitch needs to be correctly detected. Make sure the the footswitch is properly connected. Turn the piano on while not touching the pedal.</p>

# Specifications

Keyboard:	88 weighted velocity-sensitive keys
Display:	Multi-Function LCD Display
Polyphony:	128
Voice:	137
Pedal:	Sustain, Sostenuto, Soft
EQ:	Bass [-12,+12]dB, Treble [-12,+12]
Effect:	Reverb(8 types),Reverb Level, Chorus(13 types),Chorus Level
style:	100
style Feature:	Syschro start, Intro, Ending, Fillin, Variation, Chord, Acc Volume, Metronome
Keyboard control	Split,Layer,Duet,Tune,Transpose,6 Touch Sensitivity
Demo	10 demo + 376 learning songs
Learning function	Left/Right learning
Song recording	Two melody tracks and one Accompaniment track recording in local memory
Others	AutoPower off, Local Control, USB MIDI/USB AUDIO
Interface	DC Power, Headphone, Line OUT, Line In, MIC, USB Host, Midi Out
Dimensions(W x D x H):	53.5 X 15.1 X 30.5 inches,1270mm x 270mm x 180 mm
Weight:	92.6lbs or 42Kg

## FCC STATEMENT

1. This device complies with Part 15 of the FCC Rules. Operation is subject to the following two conditions:

- (1) This device may not cause harmful interference.
- (2) This device must accept any interference received, including interference that may cause undesired operation.

2. Changes or modifications not expressly approved by the party responsible for compliance could void the user's authority to operate the equipment.

NOTE: This equipment has been tested and found to comply with the limits for a Class B digital device, pursuant to Part 15 of the FCC Rules. These limits are designed to provide reasonable protection against harmful interference in a residential installation. This equipment generates uses and can radiate radio frequency energy and, if not installed and used in accordance with the instructions, may cause harmful interference to radio communications. However, there is no guarantee that interference will not occur in a particular installation. If this equipment does cause harmful interference to radio or television reception, which can be determined by turning the equipment off and on, the user is encouraged to try to correct the interference by one or more of the following measures:

Reorient or relocate the receiving antenna.

Increase the separation between the equipment and receiver.

Connect the equipment into an outlet on a circuit different from that to which the receiver is connected.

Consult the dealer or an experienced radio/TV technician for help.

artesia

Virgin Musical Instrument Company INC

P O Box 2908

La Mesa, CA 91943

PH: 888-998-9848

E-mail: [info@virginmi.com](mailto:info@virginmi.com)

[Virginmusicalinstrumentscompany.com](http://Virginmusicalinstrumentscompany.com)