

DIGITAL PIANO

Owner's Manual

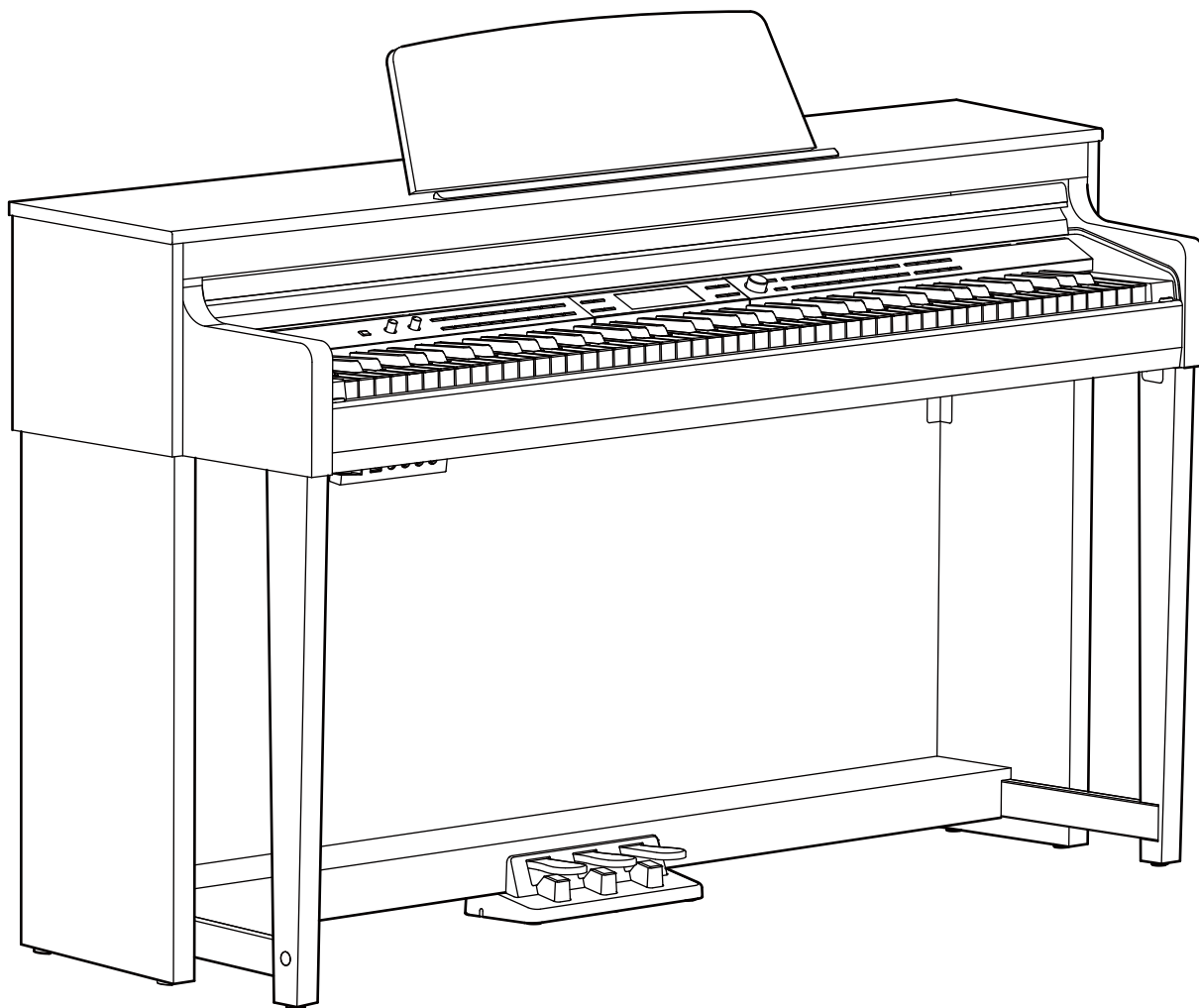

INFORMATION FOR YOUR SAFETY!

THE FCC REGULATION WARNING (for USA)

This equipment has been tested and found to comply with the limits for a Class B digital device, pursuant to Part 15 of the FCC Rules.

These limits are designed to provide reasonable protection against harmful interference in a residential installation. This equipment generates, uses, and can radiate radio frequency energy and, if not installed and used in accordance with the instructions, may cause harmful interference to radio communications. However, there is no guarantee that interference will not occur in a particular installation. If this equipment does cause harmful interference to radio or television reception, which can be determined by turning the equipment off and on, the user is encouraged to try to correct the interference by one or more of the following measures:

- Reorient or relocate the receiving antenna.
- Increase the separation between the equipment and receiver.
- Connect the equipment into an outlet on a circuit different from that to which the receiver is connected.
- Consult the dealer or an experienced radio/TV technician for help.

Unauthorized changes or modification to this system can void the user's authority to operate this equipment.

CAUTION

The normal function of the product may be disturbed by Strong Electro Magnetic Interference. If so, simply reset the product to resume normal operation by following the owner's manual. In case the function could not resume, please use the product in other location.

PRECAUTIONS

PLEASE READ CAREFULLY BEFORE PROCEEDING

Please keep this manual in a safe place for future reference.

Power Supply

Please connect the designated DC adaptor to an AC outlet of the correct voltage.

Do not connect it to an AC outlet of voltage other than that for which your instrument is intended.

Unplug the DC power adaptor when not using the instrument, or during electrical storms.

Connections

Before connecting the instrument to other devices, turn off the power to all units. This will help prevent malfunction and / or damage to other devices.

Location

Do not expose the instrument to the following conditions to avoid deformation, discoloration, or more serious damage:

- Direct sunlight
- Extreme temperature or humidity
- Excessive dusty or dirty location
- Strong vibrations or shocks
- Close to magnetic fields

Interference with other electrical devices

Radios and televisions placed nearby may experience reception interference. Operate this unit at a suitable distance from radios and televisions.

Cleaning

Clean only with a soft, dry cloth.

Do not use paint thinners, solvents, cleaning fluids, or chemical-impregnated wiping cloths.

Handling

Do not apply excessive force to the switches or controls.

Do not let paper, metallic, or other objects into the instrument. If this happens, remove the electric plug from the outlet. Then have the instrument inspected by qualified service personnel.

Disconnect all cables before moving the instrument.

Contents

Setup		
Component Guide.....	4	
Setup Guide.....	4	
Panel & Display Description		
Front Panel.....	7	
LCD Display.....	8	
Connections	9	
Power Supply	10	
Adjusting the Master Volume	10	
Adjusting the Brilliance	10	
Playing the Demos	11	
Playing the Voices		
Playing a Voice.....	11	
Playing Two Voices Simultaneously.....	12	
Playing Different Voices with Both Hands.....	12	
Transpose.....	13	
Piano Mode	13	
Twinova	14	
Auto Accompaniment		
Playing Only the Rhythm Tracks.....	15	
Playing All Tracks of a Style.....	15	
Accompaniment Variations.....	16	
Chord Basics.....	16	
Adjusting the Tempo.....	17	
One Touch Setting.....	18	
Metronome.....	18	
Metronome Beat.....	18	
Mixer	19	
DSP Effect	20	
Harmony	21	
Function Menu		
Tune.....	23	
Octave.....	23	
Touch Response.....	23	
Chord Type.....	23	
Lower Split Point.....	23	
Twinova Split Point / Octave.....	23	
Harmony Type.....	24	
EQ.....	24	
String Resonance.....	24	
Soft Pedal.....	24	
Freeze.....	25	
Metronome Beat.....	25	
Fade Time.....	25	
MIDI Out Channel.....	25	
Song Looping.....	25	
Auto Power Off.....	25	
System Time.....	26	
Factory Reset.....	26	
Performance Memory		
Registering the Panel Settings.....	27	
Recalling the Memory Settings.....	27	
Selecting a Memory Bank.....	27	
Freezing Specific Settings.....	27	
Song Recording	28	
MIDI Recording		
Prepare Recording.....	28	
Start Recording.....	28	
Stop Recording.....	28	
Play Back Recording.....	28	
Audio Recording	30	
Song		
Play the Songs.....	31	
Control the Song Playback.....	31	
Practice the Songs.....	31	
Connecting USB Flash Drive		
Playing.....	32	
Saving.....	32	
Loading.....	32	
Formatting.....	32	
MIDI		
What's MIDI?.....	33	
Troubleshooting	33	
Specifications	34	
Appendices		
Voice List.....	36	
Style List.....	43	
Song List.....	45	
Demo List.....	45	
Chord List.....	46	
MIDI Implementation Chart.....	47	

Setup

This section contains information about setting up your instrument and preparing to play. Please read through this section carefully before turning the power on.

Component Guide

Check that all the parts listed below are included before proceeding to the Setup Guide.

Setup Guide

To assemble the stand, you will need a Phillip's screwdriver (not supplied).

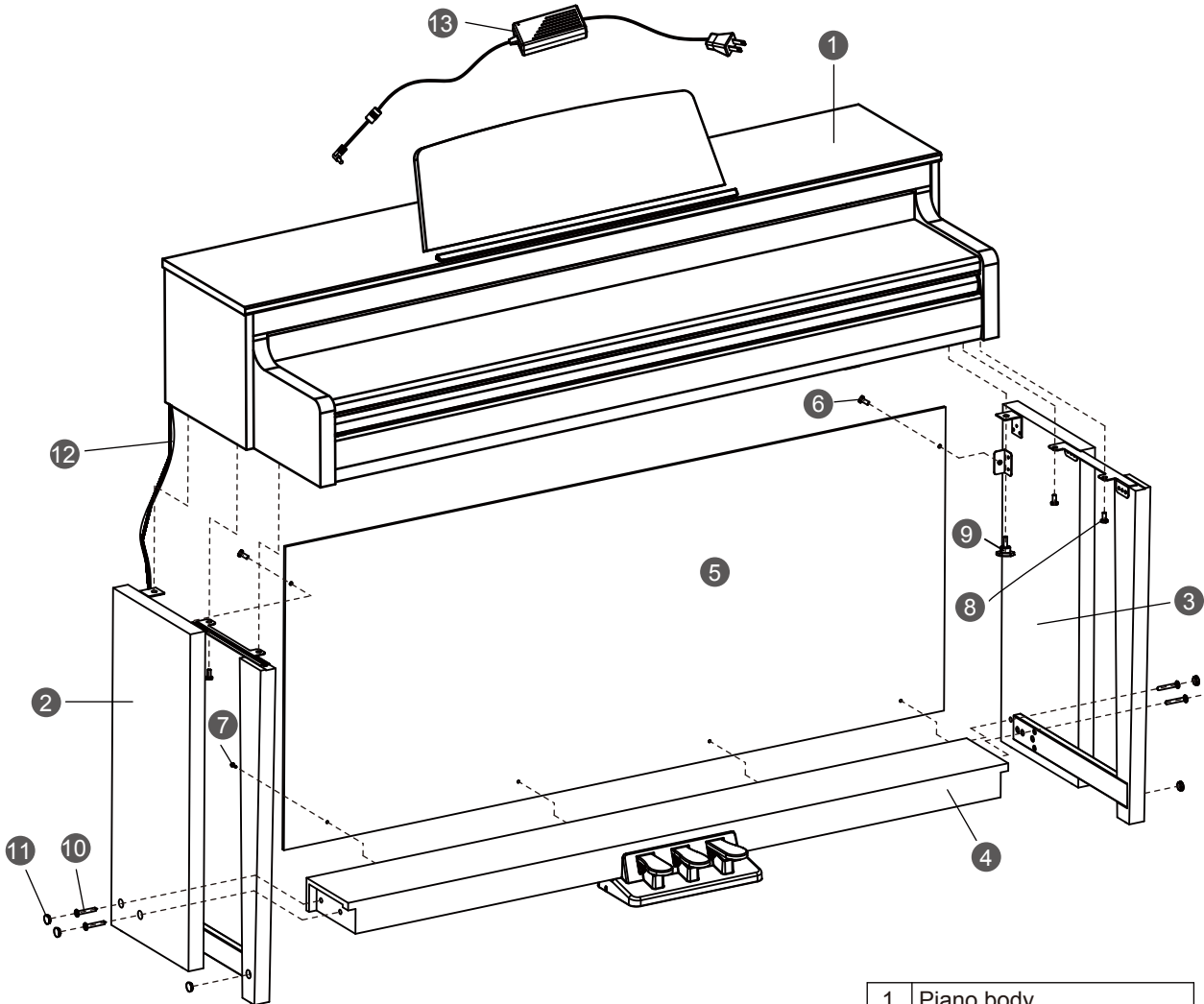

1	Piano body
2	Left stand component
3	Right stand component
4	Pedal assembly
5	Back board
6	Screws 6x12 BM (2PCS)
7	Screws 4x15 PA (4PCS)
8	Screws 6x18 BM (4PCS)
9	Hand screws (2PCS)
10	Screws 6x50 PA (4PCS)
11	Screw caps (6PCS)
12	Pedal cable
13	AC power adaptor

Setup

- A. Put the “pedal box” between the “left and right stand components.” Use “Screws 6x50PA (4pcs)” to stabilize the “left and right stand components” onto to the pedal assembly, then cover with “Screw caps (6pcs)”, as shown in the picture.

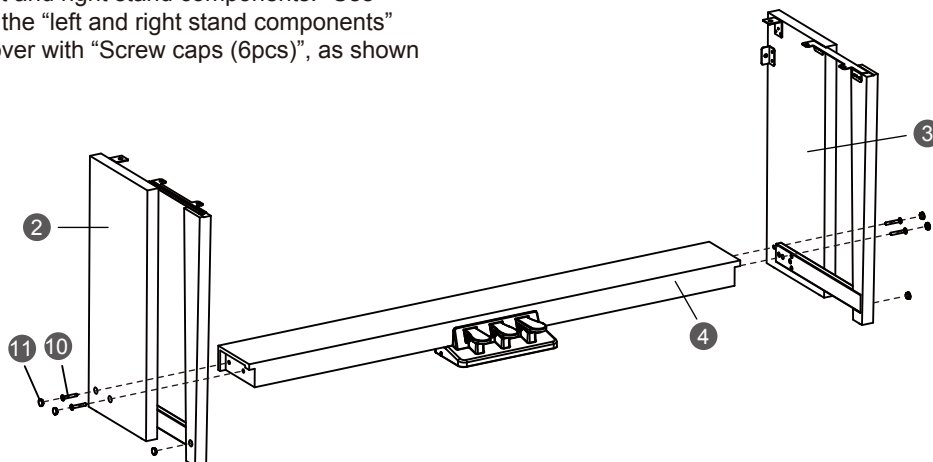

- B. Use “Screws 6x12BM(2PCS)” and “Screws 4x15PA(4PCS)” to affix the back board to the stands, as shown in the picture.

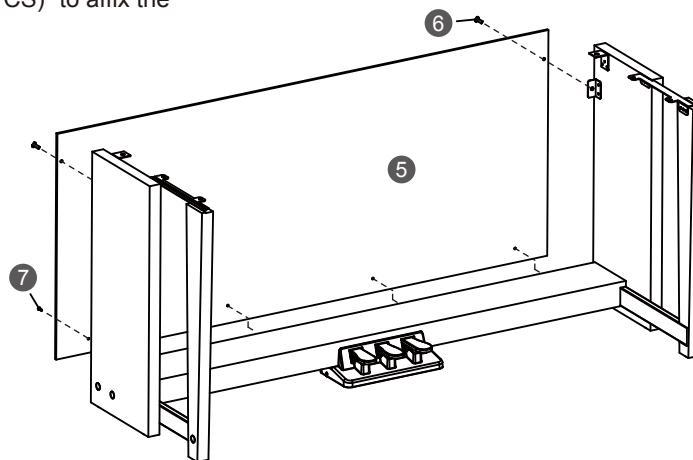

- C. Put the “piano body” on the top of the assembly finished in part B, then affix it with “Screws 6x18 BM (4PCS)” and “Hand Screws (2PCS)”, as shown in the picture.

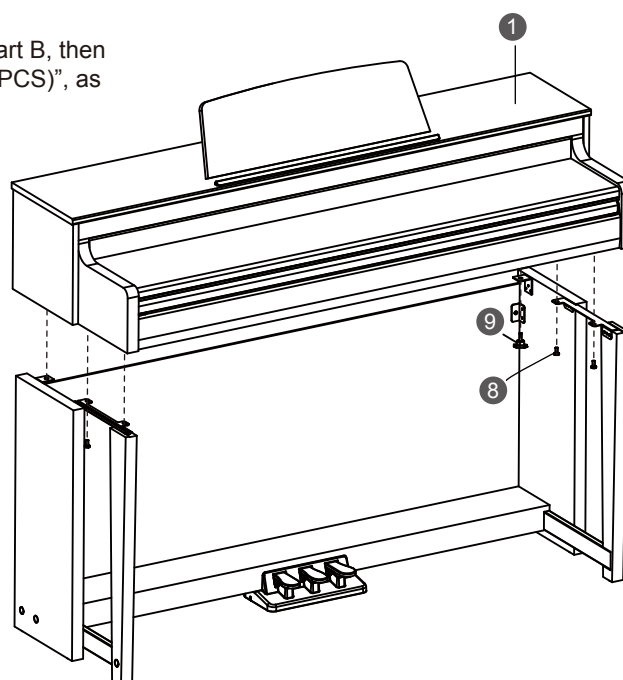

Setup

D. Connect the “pedal cable” to the pedal jack at the bottom rear of the Piano.
Then connect the power cable to the power jack, and plug the other end into an AC outlet. At this point the Piano is fully assembled and you can turn on the power.

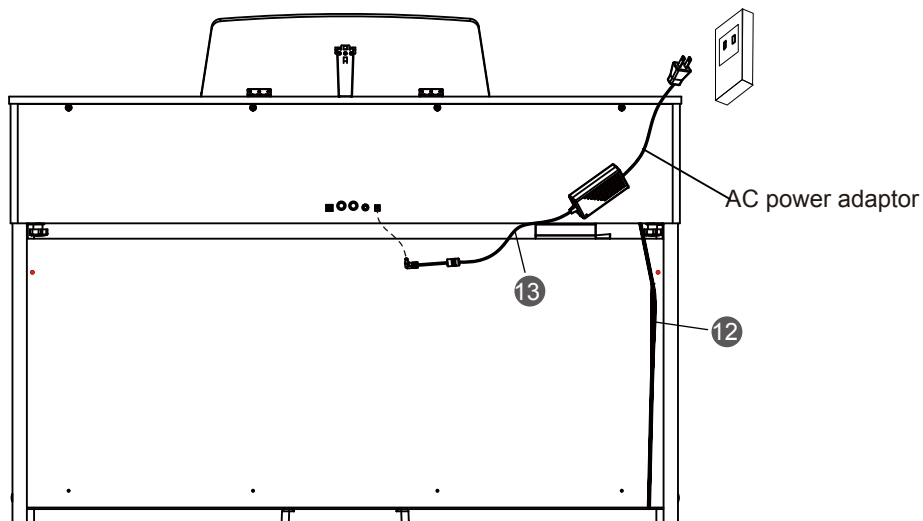

Panel & Display Description

Front Panel

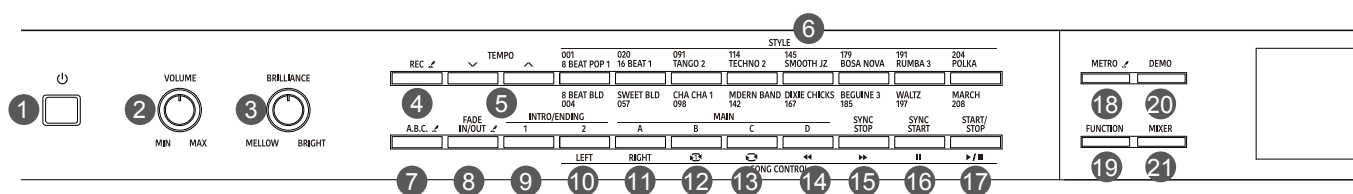

1. [POWER] Switch

Turn the power on or off.

2. [VOLUME] Knob

Adjust the master volume.

3. [BRILLIANCE] Knob

Adjust the brilliance.

4. [REC] Button

USB flash drive inserted: press the button to enter Audio Recording.

USB flash drive not inserted: press the button to enter MIDI Recording.

Press and hold the button to enter the recording setting menu.

5. [TEMPO +/-] Buttons

Press to edit the tempo value.

6. STYLE Select Buttons

Directly set a preset style. Press a button once to select the first preset style, press it again to select the second preset style.

7. [A.B.C.] Button

Press it to turn the A.B.C. function on or off.

Press and hold it to enter the Chord setting menu.

8. [FADE IN/OUT] Button

Press it to turn the Fade In or Fade Out on or off.

Press and hold it to enter the Fade Time setting menu.

9. [INTRO/ENDING 1] Button

Play the Intro or Ending pattern 1.

10. [INTRO/ENDING 2] Button

In style mode: play the Intro or Ending pattern 2.

In song mode: mute/activate the left hand part.

11. [MAIN A] Button

In style mode: play the Main pattern A.

In song mode: mute/activate the right hand part.

12. [MAIN B] Button

In style mode: play the Main pattern B.

In song mode: play the current song in a loop.

13. [MAIN C] Button

In style mode: play the Main pattern C.

In song mode: play all songs in a loop.

14. [MAIN D] Button

In style mode: play the Main pattern D.

In song mode: rewind the song playback.

15. [SYNC STOP] Button

In style mode: turn the Sync Stop function on or off.

In song mode: fast forward the song playback.

16. [SYNC START] Button

In style mode: turn the Sync Start function on or off.

In song mode: pause the song playback.

17. [START/STOP] Button

Start or stop playing a song or a style.

18. [METRO] Button

Press it to turn the Metronome on or off.

Press and hold it to enter the Metronome setting menu.

19. [FUNCTION] Button

Press it to enter the Function menu.

20. [DEMO] Button

Press it to enter Demo mode.

21. [MIXER] Button

Press it to enter the Mixer menu.

22. [STYLE] Button

Press it to enter Style mode.

23. [USB] Button

Press it to enter the USB Play menu.

Press and hold it to enter the USB menu.

24. [VOICE] Button

Press it to enter Voice mode.

25. [SONG] Button

Press it to enter Song mode.

Panel & Display Description

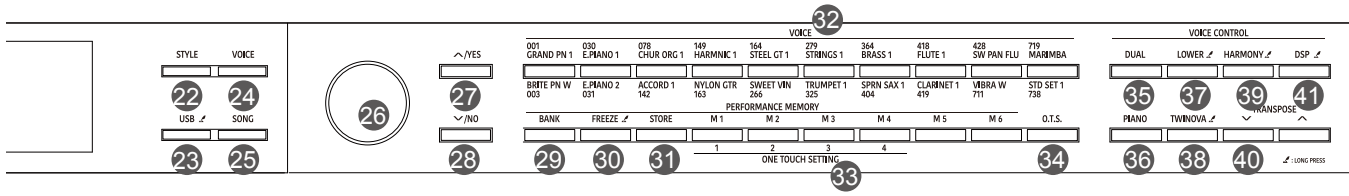

26. Data Dial
Adjust the parameters.

27. [+ / YES] Button
Increase the value.
Press [+ / YES] and [- / NO] together to restore default settings.

28. [- / NO] Button
Decrease the value.
Press [+ / YES] and [- / NO] together to restore default settings.

29. [BANK] Button
Select a memory bank.

30. [FREEZE] Button
Press it to turn the Freeze function on or off.
Press and hold it to enter the Freeze setting menu.

31. [STORE] Button
Save current panel settings to one of the memories.
Press [STORE] and [M1] together to save the settings to M1.

32. VOICE Select Buttons
Directly select a preset voice.
Press a button once to select the first preset voice, press it again to select the second preset voice.

33. [M1]-[M6] Buttons
In memory mode: recall panel settings from one of the memories.
In O.T.S. mode: recall voice settings that match the current style.

34. [O.T.S.] Button
Press it to turn the One Touch Setting function on or off.

35. [DUAL] Button
Press it to turn the Dual function on or off.

36. [PIANO] Button
Press it to enter Piano Mode.

37. [LOWER] Button
Press it to turn the Lower function on or off.
Press and hold it to enter the Split Point setting menu.

38. [TWINOVA] Button
Press it to turn the Twinova function on or off.
Press and hold it to enter the Twinova Split setting menu.

39. [HARMONY] Button
Press it to turn the Harmony function on or off.
Press and hold it to enter the Harmony setting menu.

40. [TRANPOSE +/-] Buttons
Adjust the transpose value.

41. [DSP] Button
Press it to turn the DSP effect on or off.
Press and hold it to enter the DSP setting menu.

LCD Display

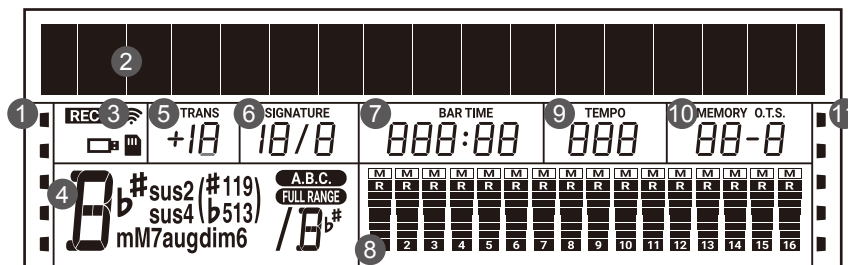

- 1. Function Indicators
- 2. 192x16 Dot Matrix LCD
- 3. Function Indicators
- 4. Chord
- 5. Transpose
- 6. Beat
- 7. Measure/Beat/Time
- 8. During playback, shows the MIDI Channel Volume
When playback stops, shows the track Volume
- 9. Tempo
- 10. Memory/O.T.S.
- 11. Function Indicators

Connections

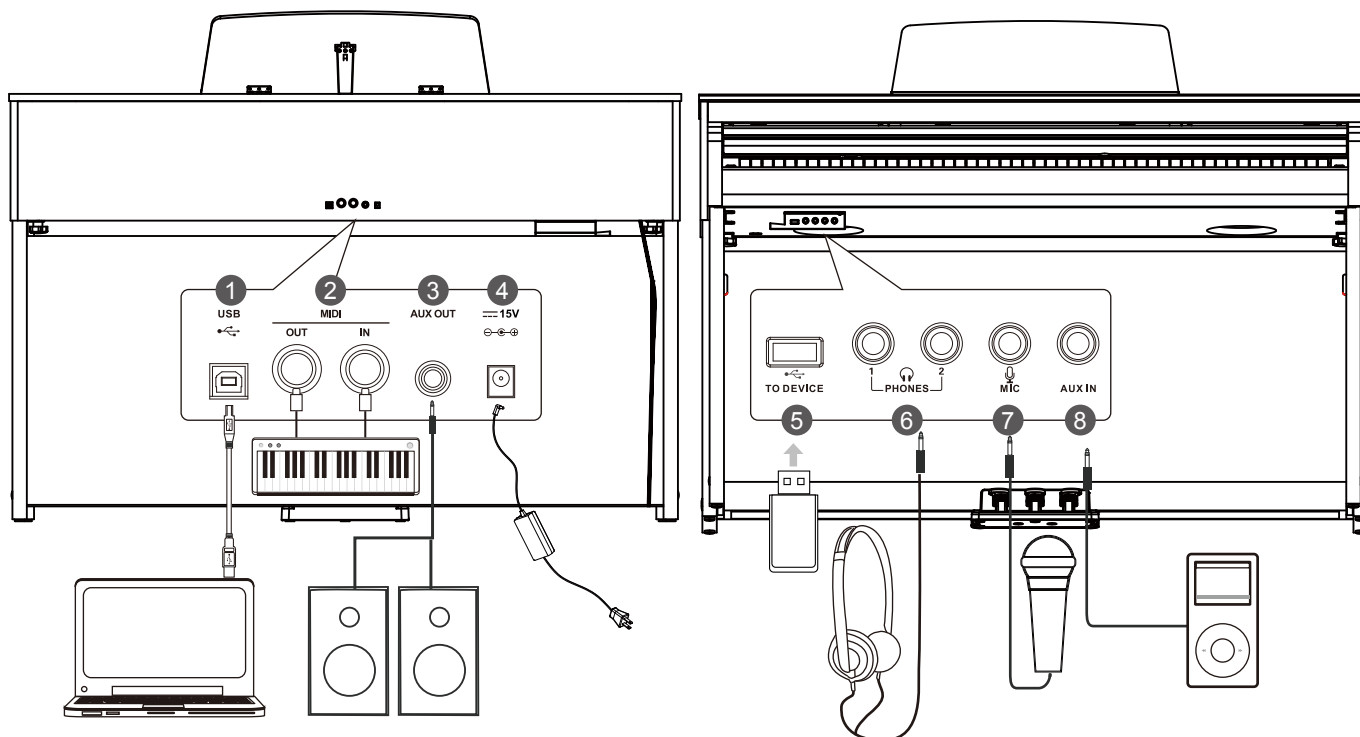

1. USB Jack

Use a standard USB cable to connect the USB jack of the instrument to the USB port of a computer. With USB, you can save a keyboard performance to the computer or use the instrument to play back music played on the computer.

Note:

Do not set the USB MIDI device to be both input and output simultaneously when configuring the software on your computer. Otherwise, the sound will be overlapped when playing the keyboard.

2. MIDI OUT, MIDI IN Jacks

Use a standard MIDI cable to connect the MIDI OUT jack of the instrument to the MIDI IN jack of an external device. The instrument will transmit MIDI messages to the external device and work as a MIDI controller.

Use a standard MIDI cable to connect the MIDI IN jack of the instrument to the MIDI OUT jack of an external device. The instrument will receive MIDI messages from the external device and work as a sound source.

3. AUX OUT Jack

The AUX OUT jack delivers the output of the instrument to external audio equipment such as a keyboard amplifier, stereo sound system, mixing console, or recording interface. Use an audio cable to connect the AUX OUT jack of the instrument to the INPUT jack of the external audio equipment.

Notes:

1. Turn off the power to all devices before connecting or disconnecting external equipment.
2. To avoid damaging the speakers, set the master volume level to minimum before turning on the power.

4. DC IN Jack

Connect the specified power adaptor.

5. USB Port

Connect a USB flash drive to the instrument to save the data you've created to the USB flash drive. You can also load files from a USB flash drive to the instrument, or use the instrument to play back files saved on USB flash drive.

Note:

To avoid errors or damaging the USB flash drive, do not remove it when reading or writing is in progress

6. PHONES Jack

Plug a pair of standard stereo headphones into the PHONES jack for private practice or late-night playing. When headphones are connected, the internal speakers will be muted, and the sound can only be heard from the headphones.

Note:

To avoid the risk of hearing loss, do not use headphones at high volume level for a long period of time.

7. MIC Jack

Before connecting or disconnecting a microphone, set the master volume level to minimum. Plug the microphone into the MIC jack, then adjust the master volume to an appropriate level.

Note:

Please unplug the microphone when it is not in use.

8. AUX IN Jack

The AUX IN jack receives audio signals from an external audio source such as an MP3 or a CD player. Use an audio cable to connect the AUX IN jack of the instrument to the OUTPUT jack of an MP3/CD player. The instrument's speakers will play the music transmitted from the external player, and you can play along.

Power Supply

1. Before connecting the power supply, please set the [POWER] switch to "OFF" and set the master volume level to minimum.
2. Connect the power adaptor to the DC IN jack on the rear panel.
3. Plug the power adaptor into an appropriate AC outlet.
4. Press the [POWER] switch. The LCD will light up and display the welcome interface, indicating the instrument is powered on.
5. When you are ready to turn the instrument off, press and hold the [POWER] switch for a second. The LCD light will turn off.



Notes:

1. In order to save energy, the instrument will automatically shut down after 30 minutes when not in use. (see **Auto Power Off**).
2. For your safety, please unplug the instrument when it is not in use or during a thunderstorm.

Adjusting the Master Volume

Rotate the [VOLUME] knob clockwise to increase the master volume or counter-clockwise to decrease it. Adjust to set the desired volume level.

Note:

If the speakers do not produce sound, check if the master volume is set too low or if headphones are plugged into the PHONES jack.

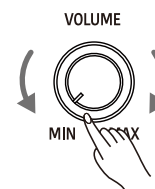

Adjusting the Brilliance

Use the [BRILLIANCE] knob to adjust the overall brilliance level. The brilliance is set to medium by default. Rotate the knob clockwise to brighten the sound, or counter-clockwise to mellow the sound.

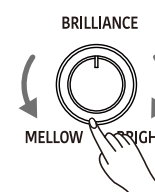

Playing the Demos

The instrument features several professional demos. Please refer to the **Demo List** for details.

1. Start playing the demo.
Press the [DEMO] button to enter Demo mode and start playing the demos in a continuous loop. The LCD shows the current demo number and name.
2. Select a demo.
Use the data dial or [+/Yes]/[-/No] buttons to select a desired demo.
3. Stop playing the demo.
Press the [START/STOP] button to stop playing and exit Demo mode.

Note:

During demo playback, playing the keyboard will not produce sound.

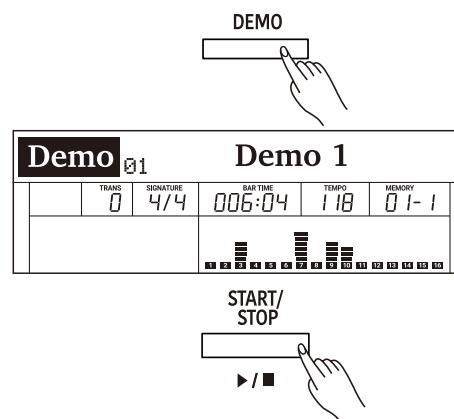

Playing the Voices

The instrument features a variety of realistic voices. Please refer to the **Voice List** for details.

Playing a Voice

1. Enter the voice mode.
Press the [VOICE] button or one of the VOICE select buttons to enter Voice mode. The "R1" indicator appears and the LCD shows the current voice number and name.
2. Select a voice to play.
Use the data dial or [+/Yes]/[-/No] buttons to select a desired voice. You can also use the VOICE select buttons to select a preset voice.
3. Play the selected voice.
Play the keyboard to use the selected voice for performance.

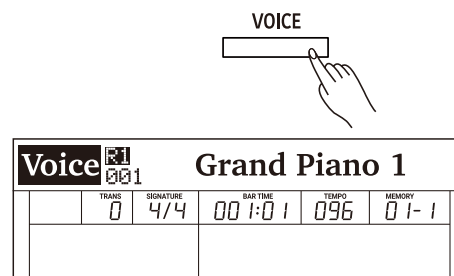

Playing the Voices

Playing Two Voices Simultaneously

The Dual function allows two different voices to be layered together, creating a more full and rich sound. Turn this function on and select a voice for the dual voice "R2".

1. Turn on the dual function.
Press the [DUAL] button to turn on the Dual function. The "R2" indicator appears and the LCD shows the current dual voice number and name.
2. Select a dual voice.
Use the data dial or [+ / Yes] / [- / No] buttons to select a dual voice. You can also use the VOICE select buttons to select a preset voice.
3. Play the voices.
Play the keyboard and you will hear two different voices playing together, just like two different instruments being played at the same time.
4. Turn off the dual function.
Press the [DUAL] button again to turn off the Dual function.

DUAL

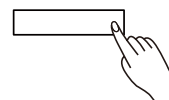

Voice	R1	R2	Modern EP 2		
	034				
	TRANS	SIGNATURE	BAR TIME	TEMPO	MEMORY
	0	4/4	00 1:0 1	096	0 1- 1

Playing Different Voices with Both Hands

The Lower function splits the keyboard into two areas so as to create different voices for each of your hands. The left hand voice is the lower voice "L".

1. Turn on the lower function.
Press the [LOWER] button to turn on the Lower function. The "L" indicator appears. The LCD shows the current lower voice number and name.
2. Select a lower voice.
Use the data dial or [+ / Yes] / [- / No] buttons to select a lower voice. You can also use the VOICE select buttons to select a preset voice.
3. Play the voices.
Play the keyboard with both hands and you will hear two different voices from the left and right hand areas.
4. Set the lower split.
Press and hold the [LOWER] buttons to enter the lower split setting menu, then use the [+ / Yes] / [- / No] buttons or press a key on the keyboard to assign the lower split.
Press [+ / YES] and [- / NO] at the same time to restore the default lower split.
5. Turn off the lower function.
Press the [LOWER] button again to turn off the lower function.

LOWER

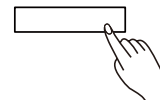

Voice	R1	R2	Electric Grand 3		
	026				
	TRANS	SIGNATURE	BAR TIME	TEMPO	MEMORY
	0	4/4	00 1:0 1	096	0 1- 1

Switch between Voice R1 / R2 / L

The voice "R1" is turned on by default, and cannot be turned off. The dual voice "R2" and lower voice "L" can be turned on/off as desired. In voice mode, when the R1, R2, and L voices are all in use, you can press the [VOICE] button repeatedly to switch between different voice layers.

Playing the Voices

Lower Split

The key that splits the keyboard into the left and right hand areas is called "Lower Split". The default lower split is F#3 (34), however, you can assign it to any other key. Please refer to the **Function Menu** for details.

Notes:

1. When the Lower and Dual functions are in use, only the right hand area will play the dual voices.
2. You can adjust the volume for voice R1/ R2/ L separately in the Mixer. Please refer to **Mixer** for details.

Transpose

The transpose function allows the overall pitch of the instrument to be transposed up or down by a maximum of one octave in semitone steps.

1. Enter the transpose setting interface.
Press the [TRANPOSE+] / [TRANPOSE-] buttons to edit the transpose setting. The LCD shows the current transpose value.
2. Adjust the transpose value.
Use the data dial, [+ / Yes] / [- / No] buttons or [TRANPOSE+] / [TRANPOSE-] to adjust the transpose value.
3. Reset the transpose to default.
Press the [TRANPOSE+] and [TRANPOSE-] buttons at the same time to reset the value to default.

Notes:

1. For example, if you set the transpose value to -05 or 007, you will hear "G" pitch when playing the "C" keys.
2. Transpose setting applies to the accompaniment and the entire keyboard voice.

Func		LOWER SPLIT			F#3	
TRANS	SIGNATURE	BAR TIME	TEMPO	MEMORY		
0	4/4	00 1:0 1	096	0 1- 1		

Default Lower Split

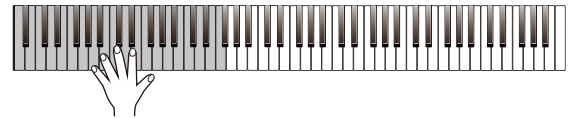

TRANPOSE

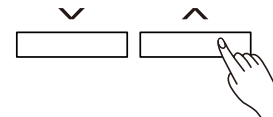

Voice		Grand Piano 1			001	
TRANS	SIGNATURE	BAR TIME	TEMPO	MEMORY		
+ 1	4/4	00 1:0 1	096	0 1- 1		

Piano Mode

Piano Mode is specially designed for piano players. It recreates the voice and touch of a real acoustic piano. By pressing the [PIANO] button, the instrument replicates a concert grand voice. All parameters become optimized for concert piano performance.

Press the [PIANO] button to enter or exit Piano Mode.

Note:

In Piano Mode, the Dual and Lower functions will not be available.

PIANO



Concert Grand					
TRANS	SIGNATURE	BAR TIME	TEMPO	MEMORY	
0	4/4	00 1:0 1	096	0 1- 1	

Twinova

The Twinova function splits the keyboard into two areas with the same pitch and voice, for the convenience of playing together with a friend or instructor.

1. Turn on the Twinova function.
Press the [TWINOVA] button to turn on the function. The default split point is E3.

2. Set the Split Point for Twinova.
Press and hold [TWINOVA] to enter the setting menu. Use the data dial to select "TWINOVA SPLIT", then use the [+ / YES] / [- / NO] buttons to assign the split point. You can also tap a key on the keyboard to assign the split point to that key.

3. Set the Octave for Twinova.
Press and hold [TWINOVA] to enter the setting menu. Use the data dial to select "TWINOVA OCTAVE", then use the [+ / Yes] / [- / No] buttons to adjust the octave range from -2 to +2.

TWINOVA 

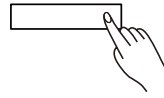

Twinova					
TRANS	SIGNATURE	BAR TIME	TEMPO	MEMORY	
0	4/4	00 1:0 1	096	0 1-1	

Func TWINOVA SPLIT E3					
TRANS	SIGNATURE	BAR TIME	TEMPO	MEMORY	
0	4/4	00 1:0 1	078	0 1-1	

Func TWINOVA OCTAVE 0					
TRANS	SIGNATURE	BAR TIME	TEMPO	MEMORY	
0	4/4	00 1:0 1	078	0 1-1	

Pedal Function in Twinova

Left Pedal: notes played on the left hand area will have longer sustain.

Middle Pedal: notes played on both areas will have longer sustain.

Right Pedal: notes played on the right hand area will have longer sustain.

Note:

In Twinova mode, both the Dual and Lower functions will not be available.

Auto Accompaniment

The auto accompaniment function puts a full backing band at your fingertips. All you have to do is to play chords with your left hand, and the accompaniment will automatically play along, following the chords you play. With auto accompaniment, even a solo performer can enjoy the experience of playing with a full band or orchestra.

The instrument features a variety of styles. Please refer to the **Style List** for details.

Playing Only the Rhythm Tracks

1. Enter the style mode.
Press the [STYLE] button to enter Style mode. The LCD shows the current style number and name.
2. Select a style to play.
Use the data dial or [+/Yes]/[-/No] buttons to select a desired style. You can also use the STYLE select buttons to select a preset style.
3. Start playing auto accompaniment of the rhythm tracks.
Press the [START/STOP] button to start playing the rhythm tracks. Alternatively, press the [SYNC START] button, then play the keyboard to start rhythm playback.

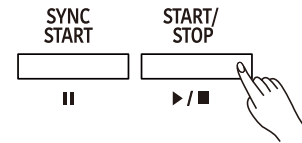
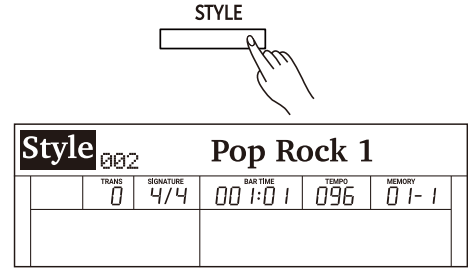

Playing All Tracks of a Style

During rhythm playback, if you turn on the chord mode and then play a chord on the keyboard, it will start the chord part as well.

In chord mode, you can play chords in the following ways: Fingered, Multi-finger, Bass Invert and Full Range. Except for Full Range, the other three will divide the keyboard into two areas (same as in the Lower function).

Chord Type	Description
Fingered	Automatically detects Single Finger and Multi Finger chords.
Multi Finger	Detects only Multi Fingerchords.
Bass Invert	Detects Multi Finger chord inversion of bass track.
Full Range	Detects Multi Finger chords over the entire keyboard range and supports Bass Invert.

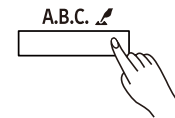

1. Turn on the A.B.C. function.
Press the [A.B.C.] button to turn on the A.B.C. Function. The LED button lights up. Press the button repeatedly to switch between "A.B.C." → "FULL RANGE" → "OFF".

To select a desired way to play chords, press and hold the [A.B.C.] button to enter the setting menu, then use the [+ / YES] / [- / NO] buttons to select a chord type.

2. Start playing auto accompaniment of all tracks.
Press the [SYNC START] button to turn on the Sync Start function. The LED button lights up. When you play a chord in the chord section, it will start the auto accompaniment of all tracks. When you play a different chord, the accompaniment will change along with you.

Alternatively, press the [START/STOP] button to start rhythm playback. Then play a chord in the chord section, and the chord part will start as well.

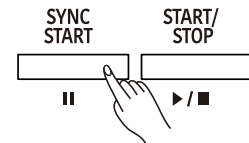
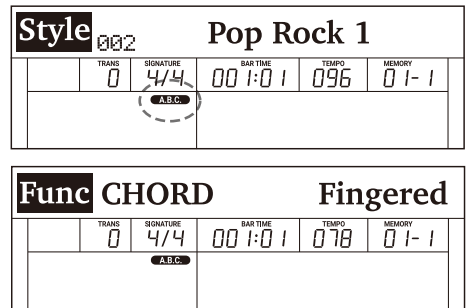

Auto Accompaniment

Accompaniment Variations

Specially created variation patterns can be added into the accompaniment, making your performance more professional and personalized.

INTRO

The Intro is the opening section of a song. When the Intro pattern is finished, it will automatically shift to the selected Main section. The length of the Intro section differs depending on the selected style.

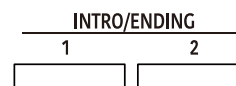

MAIN

The Main is the principal section of a song. It will play and repeat the Main pattern until another section's button is pressed.

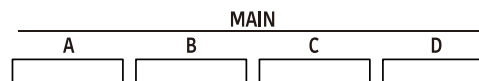

FILL IN

The Fill-in will automatically add a fill to your performance. When the Fill-in pattern is finished, it will shift to the related Main section.

ENDING

The Ending is the ending section of a song. When the Ending pattern is finished, the accompaniment will stop as well.

The length of the Ending section differs depending on the selected style.

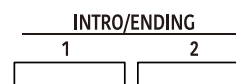

Note:

During style playback, if you press and hold one of the MAIN [A]-[D] buttons, the Fill-in pattern will repeat until the button is released. Playback will then switch to the related Main section.

Chord Basics

A chord, in music, is a harmonic set of three or more notes that are heard simultaneously. The most common type of chord is a triad. A triad is a set of three notes that can be stacked in thirds. When arranged this way, the triad's notes, from lowest pitched to highest, are called: the Root, the Third, and the Fifth.

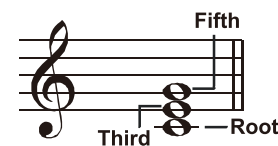

Triad Type

The basic triad types are as follows:

Major Triad	A root with a major third added above and a perfect fifth constitutes a "Major Triad".
Minor Triad	A root with a minor third added above and a perfect fifth constitutes a "Minor Triad".
Augmented Triad	A root with a major third added above and an augmented fifth constitutes an "Augmented Triad".
Diminished Triad	A root with a minor third added above and a diminished fifth constitutes a "Diminished Triad".

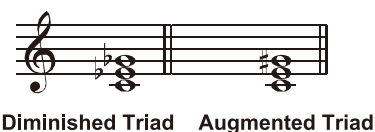
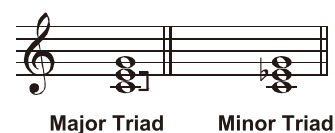

Chord Inversion

When a chord's root is not the lowest note in the triad, it is called an inversion chord. When the root note is the lowest note, it is called a root-position chord. If we put the Third and Fifth in the root position, it forms an "Inversion", so it is called an "Inverted Chord". A major triad and its inversion are illustrated on the right.



Chord Name



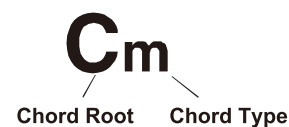

The chord name consists of two parts: Chord root and Chord type.



Auto Accompaniment

Single Finger

Single-finger makes it easy to produce major, seventh, minor and minor seventh chords by pressing a minimum number of keys on the auto accompaniment section.

	★Major Triad Only press the root note on the keyboard.
	★Minor Triad Press the root note and the nearest left black key simultaneously.
	★Seventh chord Press the root note and the nearest left white key simultaneously.
	★Minor seventh chord Press the root note and the nearest left white and black keys simultaneously.

Multi-finger

Multi-finger allows you to play chords in normal fingering. Try playing the 32 types of C chords listed on the right.

0 C	1 C ₆	2 CM ₇	3 CM ₇ (#11)	4 CM(9)	5 CM ₇ (9)
6 C ₆ (9)	7 Caug	8 Cm	9 Cm ₆	10 Cm ₇	11 Cm ₇ (b5)
12 Cm(9)	13 Cm ₇ (9)	14 Cm ₇ (11)	15 CmM ₇	16 CmM ₇ (9)	17 Cdim
18 Cdim ₇	19 C ₇	20 C ₇ sus4	21 C ₇ (b5)	22 C ₇ (9)	23 C ₇ (#11)
24 C ₇ (13)	25 C ₇ (b9)	26 C ₇ (b13)	27 C ₇ (#9)	28 CM ₇ aug	29 C ₇ aug
30 Csus ₄	31 C1+2+5	Notes enclosed in parentheses are optional; the chords could be recognized without them.			

Full Range

In Full Range mode, it detects chords played in normal fingering (Multi-finger) over the entire keyboard range.

Adjusting the Tempo

Each style is preset with a default or standard tempo, but you can change it as needed.

- Adjust the tempo.
Press the [TEMPO+]/[TEMPO-] buttons to edit the tempo setting. The tempo value will flash on the LCD. Use the data dial or [+YES]/[-NO] buttons to change the value.
- Reset the tempo to default.
When the tempo value is flashing, press the [+YES] and [-NO] buttons at the same time to reset the tempo to default.

Note:

When style stops, changing the style will automatically reset the tempo. However, changing the style during style playback will not result in tempo change.

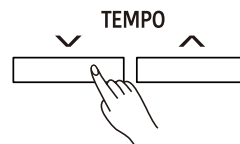

Style 002	Pop Rock 1			
TRANS	SIGNATURE	BARTIME	TEMPO	MEMORY
0	4/4	00 1:01	086	01-1
A.B.C.				

Auto Accompaniment

One Touch Setting

When One Touch Setting is switched on, you can instantly recall all auto accompaniment related settings including voice selection and digital effects, all with the single touch of a button.

1. Turn on the One Touch Setting function.
Press the [O.T.S.] button to turn on the function. The "O.T.S" indicator lights up and the A.B.C. function will be turned on.

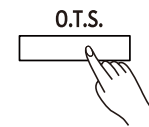

Style	002	Pop Rock 1			
TRANS	0	SIGNATURE	4/4	BAR TIME	00 1:01
				TEMPO	096
					O.T.S. 1
A.B.C.					

2. Recall the settings in O.T.S. mode.
Press one of the [M1] - [M4] buttons. Various panel settings (including voice and effects) that match the current style will be recalled instantly. Each style has 4 preset settings.

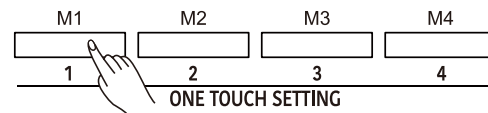

Parameters in One Touch Setting:

Part on/off, voice number, voice volume, voice octave setting, voice reverb level, voice chorus level, voice pan.

Note:

In O.T.S. mode, the Performance Memory is not available.

Metronome

The metronome provides a steady beat to help you practice at a preset tempo.

1. Turn on the metronome.
Press the [METRO] button to turn on the metronome. Beats on the LCD will flash in sync with the metronome sound.
2. Turn off the metronome.
Press the [METRO] button again to turn off the metronome.



Notes:

1. If you turn on the metronome during style playback, the metronome sound will start from the next beat and its time signature will match the current style.
2. In MIDI Recording, if you can turn on the metronome, the metronome sound will not be recorded.
3. In Audio Recording, if you turn on the metronome, the metronome sound will be recorded.

Metronome Beat

Press and hold the [METRO] button to enter the setting menu, then use the [+ / YES] / [- / NO] buttons to change the metronome beat.

Func	METRO				4/4
TRANS	0	SIGNATURE	4/4	BAR TIME	00 1:01
				TEMPO	096
					MEMORY 01-1

Mixer

The Mixer function allows you to separately adjust the volume of each track, so as to keep an appropriate volume balance.

1. Enter the Mixer menu.

Press the [MIXER] button to enter the Mixer menu. The LCD shows the current parameter.

2. Select a parameter.

Use the data dial to select a parameter.

3. Adjust the volume level.

Use the [+ / YES] / [- / NO] buttons to adjust the volume of the current item. Press [+ / YES] and [- / NO] at the same time to switch between the default volume and muting the volume.

MIXER



Mixer		MUSIC VOL:		20	
TRANS	0	SIGNATURE	4/4	BAR TIME	00 1:0 1
		TEMPO	096	MEMORY	01-1

Detailed parameters and their volume ranges:

Parameter	LCD Display	Volume Range
Music volume	MUSIC VOL: xxx	0 - 32
Voice R1 volume	R1 VOL: xxx	0 - 32
Voice R2 volume	R2 VOL: xxx	0 - 32
Voice L volume	L VOL: xxx	0 - 32
Metronome volume	METRO VOL: xxx	0 - 32
Mic volume	MIC VOL: xxx	0 - 32
Rhythm sub. volume	RHYTHM_S VOL: xxx	0 - 32
Rhythm master volume	RHYTHM_M VOL: xxx	0 - 32
Bass volume	BASS VOL: xxx	0 - 32
Chord 1 volume	CHORD1 VOL: xxx	0 - 32
Chord 2 volume	CHORD2 VOL: xxx	0 - 32
Chord 3 volume	CHORD3 VOL: xxx	0 - 32
Phrase 1 volume	PHRASE1 VOL: xxx	0 - 32
Phrase 2 volume	PHRASE2 VOL: xxx	0 - 32

DSP Effect

The DSP effects will add ambiance and depth to your performance in a variety of ways. They can be set to simulate sound from a real environment, making your tone more crystal and strong, or even give you distortion for a rougher edge. Experiment with the various effects to find the ones that work best for you.

Turn the DSP Effect on or off.

The DSP effect is turned on by default. You can press the [DSP] button to turn the function on or off.

Set the DSP Effect.

1. Press and hold the [DSP] button to enter the DSP settings menu.
2. Use the data dial to select a parameter.
3. Use the [+ / YES] / [- / NO] buttons to change the settings of the selected parameter.

DSP 

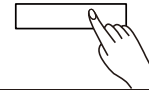

DSP R1 DSP Type					Hall
TRANS	SIGNATURE	BAR TIME	TEMPO	MEMORY	
0	4/4	00:1:01	096	01-1	

DSP effect parameters and their ranges:

Parameter	Display	Range
Voice R1 DSP Effect Type	R1 DSP TYPE xxx	Hall, Room, Crs.Dely, Tp.Delay, Tp.Echo, Chorus, Flanger, Phaser, Overdriv, Amp, Metl.Dst, Hard.Dst, Tremolo, Auto.Wah, Tp.Wah, None(Off)
Voice R1 DSP Effect Level	R1 DSP LEVEL xxx	0-32
Voice R1 Global Reverb Level Send	R1 G.REV SEND xxx	0-32
Voice R1 Global Chorus Level Send	R1 G.CHR SEND xxx	0-32
Voice R2 DSP Effect Type	R2 DSP TYPE xxx	Hall, Room, Crs.Dely, Tp.Delay, Tp.Echo, Chorus, Flanger, Phaser, Overdriv, Amp, Metl.Dst, Hard.Dst, Tremolo, Auto.Wah, Tp.Wah, None(Off)
Voice R2 DSP Effect Level	R2 DSP LEVEL xxx	0-32
Voice R2 Global Reverb Level Send	R2 G.REV SEND xxx	0-32
Voice R2 Global Chorus Level Send	R2 G.CHR SEND xxx	0-32
Voice L DSP Effect Type	L DSP TYPE xxx	Hall, Room, Crs.Dely, Tp.Delay, Tp.Echo, Chorus, Flanger, Phaser, Overdriv, Amp, Metl.Dst, Hard.Dst, Tremolo, Auto.Wah, Tp.Wah, None(Off)
Voice L DSP Effect Level	L DSP LEVEL xxx	0-32
Voice L Global Reverb Level Send	L G.REV SEND xxx	0-32
Voice L Global Chorus Level Send	L G.CHR SEND xxx	0-32
Microphone DSP Effect Type	MIC DSP TYPE xxx	Echo1, Echo2, Echo3, Phaser1, Phaser2, Enhanc, Wah, Overdv1, Overdv2, Lo-Fi, Comp, Gate, None(Off)
Microphone DSP Effect Level	MIC DSP LEVEL xxx	0-32
Microphone Global Reverb Level Send	MIC G.REV SEND xxx	0-32
Microphone Global Chorus Level Send	MIC G.CHR SEND xxx	0-32
Global Reverb Type	G.REV TYPE xxx	Hall1, Hall2, Hall3, Hall4, Pno.Hall, Room1, Room2, Room3, Church, Garage, Std.Hall
Global Reverb Level	G.REV LEVEL xxx	0-32
Global Chorus Type	G.CHR TYPE xxx	Chorus1, Chorus2, Chorus3, Chorus4, GM.Chr1, GM.Chr2, Celeste1, Celeste2, Sympho1, Sympho2, Doubler, Std.Chr
Global Chorus Level	G.CHR LEVEL xxx	0-32

Note:

There may be a slight pause in the sound if you switch the DSP effect on/off while style or song is playing.

Harmony

The harmony function will automatically add harmony effect to the notes you play in the right hand area, enriching your performance with more harmonic expression.

Playing with Harmony

1. Press the [HARMONY] button to turn on the function. The button LED lights up.
2. Turn on the A.B.C. function, then play a chord in the left hand area. When you play in the right hand area, it will add harmony effect to the notes you play.
3. Press the [HARMONY] button again to turn off the function. The LED light turns off.



Setting the Harmony Type

1. Press and hold the [HARMONY] button to enter the settings menu.
2. Use the [+ / YES] / [- / NO] buttons to change the harmony type.

Notes:

Harmony type "1+5" and "octave" are always available, but the rest will not respond until you turn on the A.B.C. function and then play a chord in the chord section.

Func		HARMONY			Duet					
TRANS	0	SIGNATURE	4/4	BAR TIME	00 1:01	TEMPO	096	MEMORY	01-1	
		A.B.C.								

Function Menu

1. Enter the function menu.
Press the [FUNCTION] button to enter the function menu. The LCD shows the current parameter.
2. Adjust the settings.
Use the data dial to select a parameter. Use the [+ /YES] /[- /NO] buttons to change the setting of the selected item. Press [+ /YES] and [- /NO] at the same time to restore the default setting.

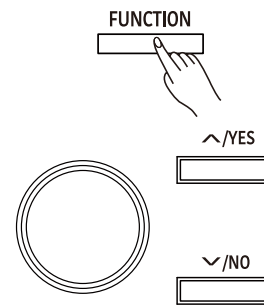

Note:

It will exit the function menu if there is no operation in 10 seconds.

Detailed parameters and their ranges:

No.	Parameter	LCD Display	Range	Default
1	Tune	TUNE	-50 ~ +50	0
2	Voice R1 Octave	OCTAVE R1	-2 ~ +2	0
3	Voice R2 Octave	OCTAVE R2	-2 ~ +2	0
4	Voice L Octave	OCTAVE L	-2 ~ +2	0
5	Touch Response	TOUCH	Off, Soft2, Soft1, Medium1, Medium2, Hard1, Hard2	Medium1
6	Chord Type	CHORD	Fingered, Multi, Bass Invert	Fingered
7	Lower Split Point	LOWER SPLIT	A0 ~ C8	F#3
8	Twinova Split Point	TWINOVA SPLIT	A0 ~ C8	E3
9	Twinova Octave	TWINOVA OCTAVE	-2 ~ 2	0
10	Harmony Type	HARMONY	Duet, Trio, Octave, 1+5, Country Duet, Block, 4 Close 1, 4 Close 2, 4 Open	Duet
11	EQ	EQ	Piano, Pop, Classical, Rock, Jazz,R&B	Piano
12	String Resonance	STRING RES.	0 ~ 32	8
13	Soft Pedal	SOFT PEDAL	Soft, Play, Memory	Soft
14	Freeze	FREEZE	Style, Voice, Song	Style
15	Metronome Time Signature	METRO	2/2~12/8	4/4
16	Fade In/Out Time	FADE TIME	1 ~ 20	10
17	MIDI Out Channel	MIDI OUT CH	1 ~ 16	1
18	Song Looping	SONG LOOP	Single, All, Off	All
19	Auto Power Off	POWER OFF	Never, 30 min, 60 min	30 min
20	System Time-Year	YEAR	2016~2100	2016
21	System Time-Month	MONTH	Jan.~ Dec.	-
22	System Time-Day	DAY	1 ~ 31	-
23	System Time-Hour	HOUR	0 ~ 23	-
24	System Time-Minute	MINUTE	0 ~ 59	-
25	Restore Factory Setting	SYSTEM RESET	-	-

Function Menu

Tune

This function adjusts the pitch of the entire keyboard in 2-cent increments over a range of ± 50 (100 cents).

1. In the function menu, use the data dial to select "TUNE".
2. Use the [+ / YES] / [- / NO] buttons to change the tune value.

Func	TUNE					00
	TRANS	SIGNATURE	BAR TIME	TEMPO	MEMORY	
	0	4/4	00 1:0 1	096	0 1- 1	
	A.B.C.					

Octave

This function will shift the pitch of the specified voice layer up or down by one octave.

1. In the function menu, use the data dial to select "OCTAVE R1" / "OCTAVE R2" / "OCTAVE L".
2. Use the [+ / YES] / [- / NO] buttons to change the octave value.

Func	OCTAVE R1					00
	TRANS	SIGNATURE	BAR TIME	TEMPO	MEMORY	
	0	4/4	00 1:0 1	096	0 1- 1	
	A.B.C.					

Note:

The default octave setting of each preset voice may differ.

Touch Response

The touch response feature allows you to expressively control the voice level based on your playing dynamics, just as on an acoustic instrument.

1. In the function menu, use the data dial to select "TOUCH".
2. Use the [+ / YES] / [- / NO] buttons to change the setting.

Note:

Your setting will be automatically saved when you press [POWER] to turn off the instrument.

Func	TOUCH					Medium1
	TRANS	SIGNATURE	BAR TIME	TEMPO	MEMORY	
	0	4/4	00 1:0 1	096	0 1- 1	
	A.B.C.					

Chord Type

You can select a desired fingering type to play chords.

1. In the function menu, use the data dial to select "CHORD".
2. Use the [+ / YES] / [- / NO] buttons to select a fingering type.

Func	CHORD					Fingered
	TRANS	SIGNATURE	BAR TIME	TEMPO	MEMORY	
	0	4/4	00 1:0 1	096	0 1- 1	
	A.B.C.					

Lower Split Point

This function assigns a key to split the entire keyboard into two areas. When the A.B.C. function is in use, the left hand area controls the playback of auto accompaniment. When A.B.C. is disabled, the left hand area plays the lower voice.

1. In the function menu, use the data dial to select "LOWER SPLIT".
2. Use the [+ / YES] / [- / NO] buttons or press any key on the keyboard to assign the split point.

Func	LOWER SPLIT					F#3
	TRANS	SIGNATURE	BAR TIME	TEMPO	MEMORY	
	0	4/4	00 1:0 1	096	0 1- 1	
	A.B.C.					

Twinova Split Point / Octave

You can adjust the split point and octave for Twinova mode.

1. In the function menu, use the data dial to select "TWINOVA SPLIT" / "TWINOVA OCTAVE".
2. Use the [+ / YES] / [- / NO] buttons to change the setting.

Func	TWINOVA SPLIT					E3
	TRANS	SIGNATURE	BAR TIME	TEMPO	MEMORY	
	0	4/4	00 1:0 1	078	0 1- 1	
	A.B.C.					

Func	TWINOVA OCTAVE					0
	TRANS	SIGNATURE	BAR TIME	TEMPO	MEMORY	
	0	4/4	00 1:0 1	078	0 1- 1	
	A.B.C.					

Function Menu

Harmony Type

1. In the function menu, use the data dial to select "HARMONY".
2. Use the [+/Yes]/[-/No] buttons to select a harmony type.

Detailed harmony types:

Harmony Type	LCD Display
Duet	Duet
Trio	Trio
Octave	Octave
1+5	1+5
Country Duet	CountryDuet
Block	Block
4 Close 1	4Close1
4 Close 2	4Close2
4 Open	4Open

Func	HARMONY				Duet
	TRANS	SIGNATURE	BAR TIME	TEMPO	MEMORY
	0	4/4	00 1:01	096	0 1-1

EQ

An EQ controls the gain value of different frequency bands. Different gain settings will produce different sound effects.

1. In the function menu, use the data dial to select "EQ".
2. Use the [+ /YES] / [- /NO] buttons to change the setting.

Func	EQ				Piano
	TRANS	SIGNATURE	BAR TIME	TEMPO	MEMORY
	0	4/4	00 1:01	096	0 1-1

String Resonance

When a piano voice is selected, pressing the sustain pedal will add a string resonance effect to the notes you play. The string resonance effect faithfully recreates the resonance from the strings and soundboard of an acoustic grand piano.

1. In the function menu, use the data dial to select "STRING RES.".
2. Use the [+ /YES] / [- /NO] buttons to change the setting.

Note:

Your setting will be automatically saved when you press [POWER] to turn off the instrument.

Func	STRING RES.				8
	TRANS	SIGNATURE	BAR TIME	TEMPO	MEMORY
	0	4/4	00 1:01	096	0 1-1

Soft Pedal

You can assign other pedal functions to the soft pedal.

1. In the function menu, use the data dial to select "SOFT PEDAL".
2. Use the [+ /Yes] / [- /No] buttons to select a pedal function.

Detailed pedal functions:

Pedal Function	Description
Soft	Press the pedal to make notes played on the keyboard sound softer.
Play	Press the pedal to start or stop playing the style.
Memory	Press the pedal to switch between the memories.

Func	SOFT PEDAL				SOFT
	TRANS	SIGNATURE	BAR TIME	TEMPO	MEMORY
	0	4/4	00 1:01	096	0 1-1

Function Menu

Freeze

When Freeze function is in use, the selected parameter setting will remain unchanged when a performance memory is recalled.

1. In the function menu, use the data dial to select "FREEZE".
2. Use the [+YES]/[-NO] buttons to select a parameter.

Note:

The setting will be usable only when Freeze function is in use.

Func	FREEZE					Style
	TRANS	SIGNATURE	BAR TIME	TEMPO	MEMORY	
	0	4/4	00 1:0 1	096	0 1-1	

Metronome Beat

1. In the function menu, use the data dial to select "METRO".
2. Use the [+YES]/[-NO] buttons to change the Beat.

Func	METRO					4/4
	TRANS	SIGNATURE	BAR TIME	TEMPO	MEMORY	
	0	4/4	00 1:0 1	096	0 1-1	

Fade Time

Set the time length (in seconds) for Fade In/Out.

1. In the function menu, use the data dial to select "FADE TIME".
2. Use the [+YES]/[-NO] buttons to change the time setting.

Func	FADE TIME					10
	TRANS	SIGNATURE	BAR TIME	TEMPO	MEMORY	
	0	4/4	00 1:0 1	096	0 1-1	

MIDI Out Channel

Set the MIDI OUT channel for Voice R1.

1. In the function menu, use the data dial to select "MIDI OUT CH".
2. Use the [+YES]/[-NO] buttons to change the MIDI Out channel.

Note:

Your setting will be automatically saved when you press [POWER] to turn off the instrument.

Func	MIDI OUT CH					01
	TRANS	SIGNATURE	BAR TIME	TEMPO	MEMORY	
	0	4/4	00 1:0 1	096	0 1-1	

Song Looping

You can play back songs in the following ways: looping all songs, looping a single song, or no looping (looping off).

1. In the function menu, use the data dial to select "SONG LOOP".
2. Use the [+YES]/[-NO] buttons to change the setting.

Note:

Your setting will be automatically saved when you press [POWER] to turn off the instrument.

Func	SONG LOOP					All
	TRANS	SIGNATURE	BAR TIME	TEMPO	MEMORY	
	0	4/4	00 1:0 1	096	0 1-1	

Auto Power Off

The instrument will automatically shut down after 30 minutes of inactivity, but you can disable this function or change the time setting.

1. In the function menu, use the data dial to select "POWER OFF".
2. Use the [+YES]/[-NO] buttons to change the time setting.

Note:

Your setting will be automatically saved when you press [POWER] to turn off the instrument.

Func	POWER OFF					30 min
	TRANS	SIGNATURE	BAR TIME	TEMPO	MEMORY	
	0	4/4	00 1:0 1	096	0 1-1	

Function Menu

System Time

You may want to set the correct system time, as it will appear on files saved to a USB flash drive and other applications.

1. In the function menu, use the data dial to select “YEAR” / “MONTH” / “DAY” / “HOUR” / “MINUTE”.
2. Use the [+ / YES] / [- / NO] buttons to set the time.

Note:

Your setting will be automatically saved when you press [POWER] to turn off the instrument.

Func		YEAR				2016
TRANS	SIGNATURE	BAR TIME	TEMPO	MEMORY		
0	4/4	00 1:01	096	01-1		

Factory Reset

1. In the function menu, use the data dial to select “SYSTEM RESET”.
2. Press [+ / YES]. The LCD will show “Reset all settings?”
3. Press [+ / YES] to confirm. Note: The operation will delete all user settings.
4. The LCD will show “Delete the user song?”
5. Press [+ / YES] to confirm. Note: The operation will delete all user songs.
6. The reset procedure may take several minutes to complete.

Note:

Do not turn off the power when factory reset is in progress, otherwise it may corrupt the internal data and cause malfunction.

Func		SYSTEM RESET			
TRANS	SIGNATURE	BAR TIME	TEMPO	MEMORY	
0	4/4	00 1:01	096	01-1	

Performance Memory

This function is designed to make your performance easy and efficient. It allows you to save virtually all panel settings to a single performance memory for instant recall.

Note:

To reset the performance memory to factory default, press and hold both the [STORE] and [M1] buttons, then turn on the power. The operation will delete all user memory.

Registering the Panel Settings

Press and hold the [STORE] button, then press one of the [M1]-[M6] buttons. This will save the current panel settings to the selected memory.

Note:

This operation will overwrite any previous data.

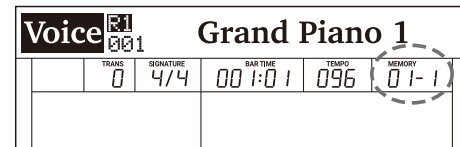

Recalling the Memory Settings

Press one of the [M1] - [M6] buttons to instantly recall the settings saved in that memory. This will reset the related parameters on the control panel.

Note:

Performance memory cannot be recalled when the O.T.S. function is in use.

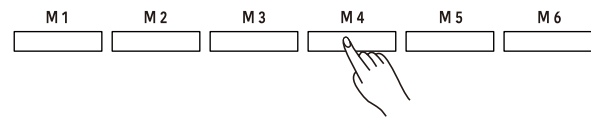

Selecting a Memory Bank

1. Press the [BANK] button. The LCD shows the current bank number.
2. Use the data dial to select a memory bank. You can also press the [BANK] button repeatedly to select a bank.

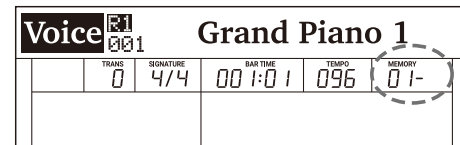
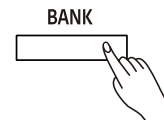

Freezing Specific Settings

When Freeze function is in use, specified panel parameters will remain unchanged even when a performance memory is recalled.

1. In memory mode, press the [FREEZE] button to turn on the function. The LED lights up.
2. Press the button again to turn off the function. The LED turns off.
3. Press and hold [FREEZE] to enter the settings menu. You can select to freeze voice, style, or song settings. Please refer to the **Function Menu** for details.

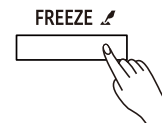

Song Recording

You can record your performance in two ways: MIDI recording and Audio recording.

MIDI Recording

In MIDI recording, you can record and save your keyboard performance as a user song on the instrument. You can then play it back and save it to a USB flash drive.

Prepare Recording

1. Press the [REC] button to enter recording standby mode. The Record button LED and the “REC” indicator will blink.

Note:

If a USB flash drive has been inserted, press and hold the [REC] button to enter the Recording settings menu, then set the Record Type to “MIDI”. You can select to save the MIDI recording to either the internal flash memory or the connected USB flash drive. Please refer to **Recording Settings** for details.

After configuring the settings, press the [REC] button to enter recording standby mode.

2. In recording standby mode, you can set the instrument voice, song style, tempo and so on.
3. In recording standby mode, press the [REC] button again to exit recording.

Start Recording

In recording standby mode, press the [START/STOP] button or simply play the keyboard to start recording. The [REC] button LED and the “REC” indicator stop blinking and stay lit.

Alternatively, you can turn on the Sync Start function, then play the keyboard to start recording.

Stop Recording

1. During recording, press the [REC] button to stop recording. The Record button LED and the “REC” indicator will turn off.
2. If the memory gets full during recording, recording will stop and be saved automatically.

Play back Recording

1. During recording, if you press the [REC] button to stop recording, it will enter Song mode and show the recorded song. Press the [START/STOP] button to play back the user song.
2. In standby mode, press the [SONG] button to enter Song mode, then use the [+ / YES] / [- / NO] buttons to select the user song. Press the [START/STOP] button to play back the song.

Recording Settings

1. Press and hold the [REC] button to enter the Recording settings menu.
2. Use the data dial to select a parameter.
3. Use the [+ / YES] / [- / NO] buttons to change the settings.
4. After configuring the settings, follow the normal procedures to enter Recording mode.

28

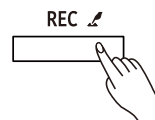

Voice 001		Grand Piano 1			
REC	TRANS	SIGNATURE	BAR TIME	TEMPO	MEMORY
0	0	4/4	00 1:01	096	01-1

Song 161		User Song			
REC	TRANS	SIGNATURE	BAR TIME	TEMPO	MEMORY
0	0	4/4	00 1:01	096	01-1

Rec Record Type:		MIDI			
REC	TRANS	SIGNATURE	BAR TIME	TEMPO	MEMORY
0	0	4/4	00 1:01	096	01-1

Song Recording

Parameter	LCD Display	Range
Record Type Setting	Record Type: xxx	MIDI, MP3
MIDI Recording Channel 1	Ch1:R1 xxx	On, Off
MIDI Recording Channel 2	Ch2:R2 xxx	On, Off
MIDI Recording Channel 3	Ch3:L xxx	On, Off
MIDI Recording Channel 4	Ch4:MIDI Ch4 xxx	On, Off
MIDI Recording Channel 5	Ch5:MIDICh5 xxx	On, Off
MIDI Recording Channel 6	Ch6:MIDICh6 xxx	On, Off
MIDI Recording Channel 7	Ch7:MIDICh7 xxx	On, Off
MIDI Recording Channel 8	Ch8:MIDICh8 xxx	On, Off
MIDI Recording Channel 9	Ch9:Rhythm_s xxx	On, Off
MIDI Recording Channel 10	Ch10:Rhythm_m xxx	On, Off
MIDI Recording Channel 11	Ch11:Bass xxx	On, Off
MIDI Recording Channel 12	Ch12:Chord1 xxx	On, Off
MIDI Recording Channel 13	Ch13:Chord2 xxx	On, Off
MIDI Recording Channel 14	Ch14:Chord3 xxx	On, Off
MIDI Recording Channel 15	Ch15:Phrase1 xxx	On, Off
MIDI Recording Channel 16	Ch16:Phrase2 xxx	On, Off
Saving the MIDI Recording To	MIDI Save To: xxx	Internal Flash, USB Flash

Note:

- The settings of the first and the last items above cannot be changed until a USB flash drive is inserted. Please refer to **Connecting USB Flash Drive** for details.
- If you have used the DSP effects during MIDI recording, when you play back the MIDI file, the preset DSP effects for voice R1/ R2/ L will be disabled and the relevant DSP Types will be set to OFF and cannot be changed. The DSP effects for the voice layers will work again only when you pause, stop or exit MIDI playback.
- If you use channel 4 - 8 for recording, connect an external MIDI keyboard or other MIDI device via either the USB jack or the MIDI jack, and then set the device's MIDI Out channels accordingly.

Audio Recording

Audio recording will record your performance and save it to a USB flash drive as an MP3 file. During recording, the sounds and effects you hear from the instrument will all be recorded.

1. Connect a USB flash drive to the instrument, then wait until the USB indicator appears on the LCD.
2. Press the [REC] button to start recording. The Record button LED and “REC” indicator will light up.

Note:

If you want to switch to MIDI recording, press and hold the [REC] button to enter the Recording settings menu, then set the Record Type to “MIDI”. Please refer to **Recording Settings** for details.

3. During recording, you can play back style accompaniment, play the keyboard, play back songs or demos, play back music from the AUX IN jack, and sing through a microphone. All these sounds will be recorded.
4. During recording, press the [REC] button to stop recording. The recording button LED and the “REC” indicator will turn off.
5. The recorded song will be automatically saved as “AudioRec XXX”. Press the [START/STOP] button to play back the song.

Note:

Do not remove the USB flash drive or turn off the power when song saving is in progress, otherwise it may cause damage to the audio files and the USB flash drive.

Voice		Grand Piano 1			
TRANS	SIGNATURE	BAR TIME	TEMPO	MEMORY	
0	4/4	00 1:0 1	096	0 1- 1	
[REC]					

REC

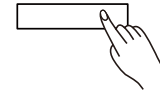

USB		AudioRec001			
TRANS	SIGNATURE	BAR TIME	TEMPO	MEMORY	
0	4/4	00 1:0 1	096	0 1- 1	
[REC]					

Song

The instrument features several complete piano songs. Please refer to the **Song List** for details.

Play the Songs

1. Press the [SONG] button to enter Song mode. The LCD shows the current song number and name.
2. Use the data dial or [+ / YES] / [- / NO] buttons to select a desired song.
3. Press the [START / STOP] button to start or stop song playback.

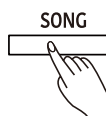

Song ₀₀₁		Red River Valley			
TRANS	SIGNATURE	BAR TIME	TEMPO	MEMORY	
0	4/4	00 1:01	095	01-1	

Note:

You can set to playing a single song or all songs in a loop. Please refer to the **Function Menu** for details.

Control the Song Playback

1. Fast Forward, Rewind or Pause the Playback
 During song playback:
 Press the [▶▶] button to fast forward the song.
 Press the [◀◀] button to rewind the song (based on the measure).
 Press the [⏸] button to pause the song. Press it again to continue the playback.
2. Song Looping
 Press [↺] button when playing songs to play the current song in a loop.
 Press [↻] button when playing songs to play all the songs in a loop.



Practice the Songs

All the preset songs can be practiced with melody-off.

1. Press the [LEFT] button to mute the left-hand melody. The “L-OFF” indicator will light up. You can then practice the left hand melody of the song.
2. In the same way, press the [RIGHT] button to mute the right-hand melody. The “R-OFF” indicator will light up. You can then practice the right hand melody of the song



Song ₀₀₁		Red River Valley			
TRANS	SIGNATURE	BAR TIME	TEMPO	MEMORY	
0	4/4	00 1:01	095	01-1	

Song ₀₀₁		Red River Valley			
TRANS	SIGNATURE	BAR TIME	TEMPO	MEMORY	
0	4/4	00 1:01	095	01-1	

Connecting USB Flash Drive

The instrument recognizes USB flash drives (32M to 128G) in FAT32 format. It does not support multi-partitioned USB flash drives. We recommend formatting the USB flash drive on the instrument before using.

Note:

A USB flash drive in FAT32 format supports up to 512 files under its root directory. Exceeding this limit will make it unable to save or record to the USB flash drive.

Playing

1. Press the [USB] button to enter the USB Play menu. The LCD shows all MIDI and MP3 songs under the root directory of the USB flash drive.
2. Use the data dial or [+ / YES] [- / NO] buttons to select a song.
3. Press the [START / STOP] button to start playback. You can set to loop play a single song or all songs. Please refer to the **Function Menu** for details.
4. Press the [START / STOP] button again to stop playback.

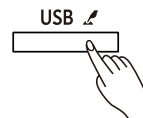

USB		AudioRec001				
	TRANS	SIGNATURE	BAR TIME	TEMPO	MEMORY	
001	0	4/4	00:1:01	096	01-1	

Saving

1. Press and hold the [USB] button to enter the USB menu. Use the data dial to select "Save MIDI".
2. Press [+ / YES] to save the user song to the root directory of the USB flash drive. The file will be saved as "UserSong00X_YYMMDD_NUB.MIDI". If the user song is empty, the LCD will prompt "NoFile!".
3. After saving, the LCD will prompt "User song save successful!", then return to the USB menu.

USBMenu		Save MIDI				
	TRANS	SIGNATURE	BAR TIME	TEMPO	MEMORY	
001	0	4/4	00:1:01	096	01-1	

File Name Description:

"UserSong00X" is the user song name and number (corresponds to the user song on the instrument).

"YYMMDD" is the year, month and date the song was saved.

"NUB" is the track number of the saved song (001~512).

Loading

1. Press and hold the [USB] button to enter the USB menu. Use the data dial to select "Load MIDI".
2. Press [+ / YES]. The LCD will show all MIDI files (*.mid) under the root directory. Use the data dial to select one.
3. Press the [+ / YES] button. The LCD will prompt "Load MIDI Successful!". If the user song on the instrument is not empty, the LCD will prompt "Over-write the User Song?" Press the [+ / YES] button to confirm loading or press [- / NO] to cancel.
4. After loading, the LCD will return to the USB menu.

USBMenu		Load MIDI				
	TRANS	SIGNATURE	BAR TIME	TEMPO	MEMORY	
001	0	4/4	00:1:01	096	01-1	

Note:

This operation will overwrite the previous user song on the instrument.

Formatting

1. Press and hold the [USB] button to enter the USB menu. Use the data dial to select "Format USB".
2. Press [+ / YES]. The LCD will prompt "Format USB Flash Drive?".
3. Press [+ / YES] to format the flash drive or press [- / NO] to cancel.
4. After formatting, it will return to the USB menu.

Notes:

1. Formatting will delete all data on the USB flash drive!
2. It may take several minutes to format a USB flash drive of large capacity.

USBMenu		Format USB				
	TRANS	SIGNATURE	BAR TIME	TEMPO	MEMORY	
001	0	4/4	00:1:01	096	01-1	

The MIDI function will expand your musical possibilities.

What's MIDI?

MIDI (short for Musical Instrument Digital Interface) allows a wide variety of electronic musical instruments, computers and other related devices to connect and communicate with one another. MIDI carries event messages that specify notation, pitch and velocity, controls signals for parameters such as volume, vibrato, audio panning, and programs change information to change the voice selections.

The instrument can output real-time playback information via MIDI messages and control external MIDI devices. The instrument can also accept incoming MIDI messages and generate sound accordingly.

Troubleshooting

Problem	Possible Cause and Solution
The speakers produce a pop sound whenever the power is turned ON/OFF.	This is normal and is no cause for alarm.
Speakers do not produce sound when the keyboard is played.	<ol style="list-style-type: none"> 1. Check if the master volume is set too low. 2. Check if headphones are plugged into the PHONES jack. 3. Check if the R1/R2/L1 voice volume is set too low (in the Mixer).
There is noise when I use a mobile phone.	Using a mobile phone in close proximity to the instrument may produce interference. To prevent this, turn off the mobile phone or keep it away from the instrument when in use.
The auto accompaniment does not play back even when Sync is in standby and a key is pressed.	You may be playing keys in the right hand range of the keyboard. To start the accompaniment with Sync Start, make sure to play keys in the left-hand range.
Certain notes seem to be in the wrong pitch.	Make sure that the tune value is set to 0. Hold down the [+ / YES] and [- / NO] buttons and turn on the power to restore factory settings.
When connecting to computer, the instrument cannot be recognized.	Check if the USB cable is firmly connected. Try connecting another USB port on the computer. This instrument is plug and play and should work without installing a driver.
The pedal does not respond.	Check if the pedal cable is firmly connected.
It cannot read/save to the USB flash drive.	Make sure your USB flash drive is in FAT32 format and not multi-partitioned.
It shuts down after a period of time.	The auto power off function will turn off the instrument after a preset period of time when the instrument is not in use. You can adjust the auto-off function in the Function Menu.

Specifications

Keyboard & Display	
Keyboard	88 Graded Hammer-Action Keys
Touch Response	6 types, Off
Display	Multi-functional LCD
Voices	
Polyphony (max.)	256
Voices	750 panel, 13 drum kits
Layer	Left, Right1, Right2
Split	Yes
Duo (Twinova)	Yes
Styles	
Styles	240 presets
Style Control	Start / Stop Sync start Sync stop Intro 1 / Ending 1 Intro 2 / Ending 2 Main A / Fill in A Main B / Fill in B Main C / Fill in C Main D / Fill in D A.B.C. Fade in/out
Style Creator	—
O.T.S.	Yes
Chord Types	32
Effects	
Effects	DSP on / off; Second-generation Acoustic Piano String Resonance Simulation
Master EQ	6 types
Reverb	11 types
Chorus	12 types
Voice Effect	15 types
Performance Enhance	
Harmony	9 types
Song & Recording	
Music Library	90 preset songs; L / R hand learning
Sequencer	1 user song (16 tracks)
Demo Song	3
Audio Playback	MP3
Audio Recorder	MP3
Score Display	—
Pitch Adjustment	
Transpose	-12 ~ +12
Octave	-2 ~ +2
Tuning	-50 ~ +50
Other Functions	
Mixer	Yes (14 tracks)
Performance Memory	32 preset banks x 6
Assignable Controllers	Soft pedal
Pitch Bend	—
Modulation	—
Metronome	Yes
Tempo	30 ~ 280
Other control	Piano mode; Brilliance; Bluetooth MIDI

Specifications

Connections	
Interaction & Expansion	USB MIDI, USB Audio, Bluetooth
External Drive	USB flash drive (128G max)
Microphone	Yes (Mic effect:12 types)
Phones	2 Standard Stereo
Pedals	Sustain, Soft, Sostenuto
MIDI	In, Out
USB	USB Audio & MIDI
Input	Standard Stereo
Output	Standard Stereo
Power Supply	
Power	DC 15V / 2.5A
Power Off Protection	Yes
Amplifiers & Speakers	
Amplifiers	25W x 2, 15W x 2
Speakers	40W x 2, 25W x 2
Dimensions & Weight	
Dimensions LWH (mm)	1400 x 494 x 910
Weight (kg)	53

* All specifications and appearances are subject to change without notice.

Voice List

No.	Voice Name	LCD Name
Piano		
1	Acoustic Grand Piano 1	Grand Piano 1
2	Acoustic Grand Piano 2	Grand Piano 2
3	Bright Acoustic Piano (wide) 1	Bright Pno/Wide 1
4	Acoustic Grand Piano (dark) 1	Grand Piano/Dark 1
5	Rock Piano	Rock Piano
6	Honky Tonk Piano (wide) 1	Honky Tonk/Wide 1
7	Octave Grand Piano 1	Octave Piano 1
8	Octave Grand Piano 2	Octave Piano 2
9	Grand Piano/Live	Grand Piano/Live
10	Bright Acoustic Piano 1	Bright Piano 1
11	Grand Piano (Warm)	Grand Piano/Warm
12	Octave Grand Piano 3	Octave Piano 3
13	Octave Grand Piano 4	Octave Piano 4
14	Honky Tonk Piano 1	Honky Tonk 1
15	Harpichord (Live)	Harpichord/Live
16	Harpichord (Octave) 1	Harpsi/Octave 1
17	Harpichord 1	Harpichord 1
18	Electric Grand Piano 1	Electric Grand 1
19	Electric Grand Piano 2	Electric Grand 2
20	Pop Piano	Pop Piano
21	Piano & Strings 1	Piano&Strings 1
22	Piano & Pad 1	Piano&Pad 1
23	Piano & Choir 1	Piano&Choir 1
24	Piano & EP 1	Piano&EP 1
25	Piano & EP 2	Piano&EP 2
26	Electric Grand Piano 3	Electric Grand 3
27	Harpichord (Octave) 2	Harpsi/Octave 2
28	Harpichord & Strings	Harpsi&Strings
29	Electric Grand Piano 4	Electric Grand 4
Electric Piano		
30	Electric Piano 1	E.Piano 1
31	Electric Piano 2	E.Piano 2
32	Modern Electric Piano 1	Modern EP 1
33	Jazz Electric Piano 1	Jazz EP 1
34	Modern Electric Piano 2	Modern EP 2
35	Jazz Electric Piano 2	Jazz EP 2
36	Phase Electric Piano 1	Phase EP 1
37	Vintage Electric Piano 1	Vintage EP 1
38	Funk EP 1	Funk EP 1
39	Vintage Electric Piano 2	Vintage EP 2
40	Classic Electric Piano 1	Classic EP 1
41	Electric Piano 3	E.Piano 3
42	Tremolo EP 1	Tremolo EP 1
43	Funk EP 2	Funk EP 2
44	60's Electric Piano 1	60's EP 1
45	Vintage Electric Piano 3	Vintage EP 3
46	Warm Electric Piano	Warm EP
47	Tremolo EP 3	Tremolo EP 3
48	Electric Piano 4	E.Piano 4
49	Modern Electric Piano 3	Modern EP 3
50	Tremolo EP 2	Tremolo EP 2
51	Classic Electric Piano 2	Classic EP 2
52	Sereo Clavi	Sereo Clavi
53	Phase Clavi	Phase Clavi

54	Clavi 1	Clavi 1
55	Wah Clavi 1	Wah Clavi 1
56	Clavi 2	Clavi 2
57	Wah Clavi 2	Wah Clavi 2
58	Massiness Electric Piano	Massiness EP
59	Wah Electric Piano	Wah EP
60	Bright Electric Piano	Bright EP
61	Dark Electric Piano	Dark EP
62	Modern Jazz Electric Piano	Modern Jazz EP
63	Jump Electric Piano	Jump EP
64	Warm Jump Electric Piano	Warm Jump EP
65	Metallic Electric Piano 1	Metallic EP 1
66	Metallic Electric Piano 2	Metallic EP 2
67	Rock Electric Piano	Rock EP
68	Pop Electric Piano	Pop EP
69	Crysta Electric Piano	Crysta EP
70	Crysta Jazz Electric Piano	Crysta Jazz EP
71	Rock Electric Clavi	Rock Elec Clavi
72	Jazz Electric Clavi	Jazz Elec Clavi
73	Pop Electric Clavi	Pop Elec Clavi
74	Echo Electric Clavi	Echo Elec Clavi
Organ		
75	Drawbar Organ 1	Draw Org 1
76	Percussive Organ 1	Perc Org 1
77	Rock Organ 1	Rock Org 1
78	Church Organ 1	Church Org 1
79	Detuned Church Organ 1	Det Church Org 1
80	Percussive Organ 2	Perc Org 2
81	Detuned Percussive Organ 1	Det Prec Org 1
82	Rotary Organ 1	Rotary Org 1
83	Church Organ (octave mix) 1	ChurchOrg/Octave 1
84	Rock Organ 2	Rock Org 2
85	Detuned Organ	Detuned Org
86	Rotary Organ 2	Rotary Org 2
87	Pop Organ	Pop Org
88	Classic Organ 1	Classic Org 1
89	Jazz Organ 1	Jazz Org 1
90	Rock Organ 3	Rock Org 3
91	Rotary Organ 3	Rotary Org 3
92	Classic Organ 2	Classic Org 2
93	Detuned Drawbar Organ	Detuned DrawOrg
94	Italian 60's Organ 1	60's Org 1
95	Rock Organ 4	Rock Org 4
96	Percussive Organ 3	Perc Org 3
97	Drawbar Organ 2	Drawbar Org 2
98	Classic Organ 3	Classic Org 3
99	Italian 60's Organ 2	60's Org 2
100	Drawbar Organ 3	Drawbar Org 3
101	Vintage Organ 1	Vintage Org 1
102	Vintage Organ 2	Vintage Org 2
103	Detuned Church Organ 2	Det Church Org 2
104	Mellow Organ 1	Mellow Org 1
105	Mellow Organ 2	Mellow Org 2
106	Mellow Organ 3	Mellow Org 3
107	Mellow Organ 4	Mellow Org 4
108	Organ 1	Organ 1

Voice List

109	Organ 2	Organ 2
110	Organ 3	Organ 3
111	Reed Organ 1	Reed Org 1
112	Puff Organ 1	Puff Org 1
113	Dark Drawbar Organ	Dark Drawbar Organ
114	Soft Drawbar Organ	Soft Drawbar Org
115	Soft 60's Organ	Soft 60's Org
116	Bright 60's Organ	Bright 60's Org
117	Detuned Classic Organ	Det Classic Org
118	Bright Percussive Organ	Br Perc Org
119	Jazz Percussive Organ	Jazz Perc Org
120	Rock Percussive Organ	Rock Perc Org
121	Octave Percussive Organ	Octave Perc Org
122	Mellow Percussive Organ	Mellow Perc Org
123	Vintage Rock Organ	Vintage Rock Org
124	Dark Rock Organ	Dark Rock Org
125	Mellow Rock Organ	Mellow Rock Org
126	Soft Rock Organ	Soft Rock Org
127	Reed Rock Organ	Reed Rock Org
128	Rotary Rock Organ	Rotary Rock Org
129	Wah Rock Organ	Wah Rock Org
130	Puff Rock Organ	Puff Rock Org
131	Bright Vintage Organ	Bright Vintage Org
132	Dark Vintage Organ	Dark Vintage Org
133	Mellow Vintage Organ	Mellow Vintage Org
134	Rotary Vintage Organ	Rotary Vintage Org
135	Rock Vintage Organ	Rock Vintage Org
136	Dark Reed Organ	Dark Reed Org
137	Jazz Reed Organ	Jazz Reed Org
138	Pop Reed Organ	Pop Reed Org
139	Puff Reed Organ	Puff Reed Org
140	Rock Reed Organ	Rock Reed Org
141	Musette	Musette
142	Accordion 1	Accordion 1
143	Tango Accordion 1	Tango Accordion 1
144	Accord It Solo 1	Accord It Solo 1
145	Tango Accordion 2	Tango Accordion 2
146	Chorus Accordion	Chorus Accordion
147	Accordion 2	Accordion 2
148	Accord It Solo 2	Accord It Solo 2
149	Harmonica 1	Harmonica 1
150	Harmonica 2	Harmonica 2
151	Wah Harmonica	Wah Harmonica
152	Dark Musette	Dark Musette
153	Bright Musette	Bright Musette
154	Chorus Musette	Chorus Musette
155	Musette 2	Musette 2
156	Dark Harmonica	Dark Harmonica
157	Bright Harmonica	Bright Harmonica
158	Chorus Harmonica	Chorus Harmonica
159	Harmonica 3	Harmonica 3
160	Dark Accordion	Dark Accordion
161	Bright Accordion	Bright Accordion
162	Chorus Accordion	Chorus Accordion
Guitar & Bass		
163	Nylon Guitar	Nylon Guitar

164	Steel Guitar 1	Steel Guitar 1
165	Jazz Guitar 1	Jazz Guitar 1
166	Clean Guitar 1	Clean Guitar 1
167	Steel Guitar 2	Steel Guitar 2
168	Mandolin	Mandolin
169	Funk Guitar 1	Funk Guitar 1
170	Velocity Clean Guitar	Velocity CleanGtr
171	Lead Guitar 1	Lead Guitar 1
172	Velocity Lead Guitar	Velocity LeadGtr
173	Lead Guitar 2	Lead Guitar 2
174	Overdriven Guitar 1	OverdrivenGtr 1
175	Tremolo clean Guitar	Tremolo cleanGtr
176	12-String Guitar	12String Guitar
177	Steel Guitar 3	Steel Guitar 3
178	Clean Guitar 2	Clean Guitar 2
179	Feedback Guitar 1	Feedback Guitar 1
180	5th Distortion	5th Distortion
181	Velocity Steel Guitar	Velocity SteelGtr
182	Delay Guitar 1	Delay Guitar 1
183	Vintage Guitar 1	Vintage Guitar 1
184	Jazz Guitar 2	Jazz Guitar 2
185	Rhythm Guitar	Rhythm Guitar
186	Jazz Lead 1	Jazz Lead 1
187	Vintage Guitar 2	Vintage Guitar 2
188	Classic Guitar	Classic Guitar
189	Jazz Lead 2	Jazz Lead 2
190	Vintage Guitar 3	Vintage Guitar 3
191	Folk Guitar	Folk Guitar
192	Chorus Guitar 1	Chorus Guitar 1
193	Muted Guitar 1	Muted Guitar 1
194	Pedal Guitar	Pedal Guitar
195	Distortion Guitar 1	DistortionGtr 1
196	Chorus Guitar 2	Chorus Guitar 2
197	Tremolo Guitar 1	TremoloGuitar 1
198	Octave Guitar	OctaveGuitar
199	Chorus Guitar 3	Chorus Guitar 3
200	Tremolo Guitar 2	TremoloGuitar 2
201	Metal Guitar	Metal Guitar
202	Clean Guitar 3	Clean Guitar 3
203	Wah Guitar	Wah Guitar
204	Jazz Guitar & EP	JazzGtr&EP
205	Distortion Guitar 2	DistortionGtr 2
206	12-String Electric Guitar	12StrE.Guitar
207	Feedback Guitar 2	Feedback Guitar 2
208	12-String Guitar 1	12String Guitar 1
209	Muted Guitar 2	Muted Guitar 2
210	Funk Guitar 2	Funk Guitar 2
211	Overdriven Guitar 2	OverdrivenGtr 2
212	12-String Guitar 2	12String Guitar 2
213	Nylon Guitar & Acoustic Bass	NyGt&AcBass
214	Steel Guitar & Finger Bass	SteGt&FgBass
215	Chorus Steel Guitar	Chorus Ste Gt
216	Dark Steel Guitar	Dark Steel Gt
217	Warm Steel Guitar	Warm Steel Gt
218	Chorus Jazzy Guitar	Chorus Jazzy Gt
219	Bright Jazzy Guitar	Bright Jazzy Gt

Voice List

220	Overdriven Jazzy Guitar	Over Jazzy Gt
221	Distortion Jazzy Guitar	Dist Jazzy Gt
222	Dark Overdrive Guitar	Dark Over Gt
223	Bright Overdrive Guitar	Bright Over Gt
224	Chorus Distortion Guitar	Chorus Dist Gt
225	Dark Distortion Guitar	Dark Dist Gt
226	Bright Lead Guitar 3	Bright Lead Gt 3
227	Modern Distortion Guitar	Modern Dist Gt
228	Finger Bass 1	Finger Bass 1
229	Acoustic Bass 1	Acoustic Bass 1
230	Pick Bass 1	Pick Bass 1
231	Fretless Bass 1	Fretless Bass 1
232	Slap Bass 1	Slap Bass 1
233	Resonant Bass	Resonant Bass
234	Attack Pulse	Attack Pulse
235	Resonant Bass 2	Resonant Bass 2
236	Analog Bass 1	Analog Bass 1
237	Resonance SynBass	Resonance SynBass
238	Rock Bass	Rock Bass
239	Fretless Bass 2	Fretless Bass 2
240	Pick Bass 2	Pick Bass 2
241	Finger Slap Bass	Finger Slap Bass
242	Acoustic Bass & Cymbal	Bass & Cymbal
243	Analog Bass 2	Analog Bass 2
244	Resonant Slap Bass	Resonant SlapBass
245	Warm Synth Bass 1	Warm Syn Bass 1
246	Hammer 1	Hammer 1
247	Synth Bass (rubber)	Synth Bass (rubber)
248	Power Slap Bass	Power Slap Bass
249	Finger Bass 2	Finger Bass 2
250	Warm Synth Bass 2	Warm Syn Bass 2
251	Mute Pick Bass	Mute Pick Bass
252	Attack Pulse 2	Attack Pulse 2
253	Bright Finger Bass	Brt Finger Bass
254	Wah Finger Bass	Wah Finger Bass
255	Dark Slap Bass	Dark Slap Bass
256	Bright Pick Bass	Bright Pick Bass
257	Dark Pick Bass	Dark Pick Bass
258	Wah Pick Bass	Wah Pick Bass
259	Bright Fretless Bass	Brt Fret Bass
260	Wah Fretless Bass	Wah Fret Bass
261	Dark Fretless Bass	Dark Fret Bass
262	Bright Power Slap Bass	Bt Power Slap Ba
263	Wah Power Slap Bass	Wah Powr Slp Ba
Strings		
264	Solo Strings	Solo Strings
265	Slow Strings 1	Slow Strings 1
266	Sweet Violin	Sweet Violin
267	Sweet Cello	Sweet Cello
268	The Strings 1	The Strings 1
269	Orchestra 1	Orchestra 1
270	Slow Strings 2	Slow Strings 2
271	Contrabass 1	Contrabass 1
272	Chamber Music	Chamber Music
273	Slow Strings 3	Slow Strings 3
274	Strings & Brass 1	Strings&Brass 1

275	Strings & Brass 2	Strings&Brass 2
276	Strings & Flute	Strings & Flute
277	Strings & Oboe	Strings & Oboe
278	Arco Strings 1	Arco Strings 1
279	String Ensembles 1	Str Ensembles 1
280	Choir Aahs 1	Choir Aahs 1
281	Voice Oohs	Voice Oohs
282	Synth Voice	Synth Voice
283	Orchestra 2	Orchestra 2
284	Arco Strings 2	Arco Strings 2
285	The Strings 2	The Strings 2
286	Tremolo Strings	Tremolo Strings
287	Pizzicato Strings	Pizzicato Str
288	The Strings 3	The Strings 3
289	Synth Strings 1	Synth Strings 1
290	Synth Strings 2	Synth Strings 2
291	Synth Strings 3	Synth Strings 3
292	Orchestral Harp	Orchestral Harp
293	Violin	Violin
294	Viola	Viola
295	Cello	Cello
296	Contrabass 2	Contrabass 2
297	Choir Aahs 2	Choir Aahs 2
298	Humming	Humming
299	Analog Voice	Analog Voice
300	Orchestra Hit	Orchestra Hit
301	Bass Hit Plus	Bass Hit Plus
302	6th Hit	6th Hit
303	Euro Hit	Euro Hit
304	Slow Sweet Violin	Slow Sweet Vin
305	Dark Sweet Violin	Dark Sweet Vin
306	Bright Sweet Violin	Bright Sweet Vin
307	Slow Violin	Slow Violin
308	Dark Violin	Dark Violin
309	Bright Violin	Bright Violin
310	Slow Viola	Slow Viola
311	Dark Viola	Dark Viola
312	Bright Viola	Bright Viola
313	Slow Cello	Slow Cello
314	Dark Cello	Dark Cello
315	Bright Cello	Bright Cello
316	Dark Contrabass	Dark Contrabass
317	Bright Contrabass	Bright Contrbs
318	Slow Contrabass	Slow Contrabass
319	Dark Tremolo Strings	Dark Trem Str
320	Bright Tremolo Strings	Brt Trem Str
321	Dark Pizzicato Strings	Dark Pizz Str
322	Bright Pizzicato Strings	Bright Pizz Str
323	Dark Harp	Dark Harp
324	Bright Harp	Bright Harp
Brass & Sax		
325	Trumpet 1	Trumpet 1
326	Trombone 1	Trombone 1
327	Muted Trumpet 1	Muted Trumpet 1
328	French Horn 1	French Horn 1
329	Dark Trumpet Soft	DarkTrump Soft

Voice List

330	Tuba	Tuba
331	Trumpet 2	Trumpet 2
332	Trombone 2	Trombone 2
333	Muted Trumpet 2	Muted Trumpet 2
334	Bright Trombone 1	Bright Trombone 1
335	Dark Trombone 1	Dark Trombone 1
336	Dark Trombone 2	Dark Trombone 2
337	Resonant Trombone 1	Reson Trb 1
338	Resonant Trombone 2	Reson Trb 2
339	Brassband 1	Brassband 1
340	French Horn 2	French Horn 2
341	Warm Trumpet	Warm Trumpet
342	Bright Trumpet	Bright Trumpet
343	Chorus Trumpet	Chorus Trumpet
344	Warm Trombone	Warm Trombone
345	Bright Trombone 2	Bright Trombone 2
346	Chorus Trombone	Chorus Trombone
347	Bright Tuba	Bright Tuba
348	Warm Tuba	Warm Tuba
349	Chorus Tuba	Chorus Tuba
350	Bright Muted Trumpet	Bright Muted Trp
351	Warm Muted Trumpet	Warm Muted Trp
352	Chorus Muted Trumpet	Chorus Muted Trp
353	Bright French Horn	Bright Fr Horn
354	Warm French Horn	Warm French Horn
355	Chorus French Horn	Chorus Fr Horn
356	Dark Brass Section	Dark Br Section
357	Bright Brass Section	Brt Br Section
358	Warm Brass Section	Warm Br Section
359	Chorus Brass Section	Cho Br Section
360	Dark Analog Synth Brass	Dk Ana Syn Br
361	Bright Analog Synth Brass	Brt Ana Syn Br
362	Warm Analog Synth Brass	Warm Ana Syn Br
363	Chorus Analog Synth Brass	Cho Ana Syn Br
364	Brass Section 1	Brass Section 1
365	Brass Section 2	Brass Section 2
366	Octave Brass Section	Oct Br Section
367	French Horn Live 1	Fr Horn Live 1
368	French Horn Live 2	Fr Horn Live 2
369	Brassband 2	Brassband 2
370	Brass Section 3	Brass Section 3
371	Dark Brass 1	Dark Brass 1
372	Synth Brass 1	Synth Brass 1
373	Bright Brass Section 1	Bright Brass 1
374	Sforzato Brass	Sforzato Brass
375	Brassband 3	Brassband 3
376	Club Brass Section	Club Brass
377	Bright Brass Section 2	Bright Brass 2
378	Soft Brass Section 1	Soft Brass 1
379	Synth Brass 2	Synth Brass 2
380	Soft Synth Brass 1	Soft Synth Brass 1
381	Soft Synth Brass 2	Soft Synth Brass 2
382	Jump Brass	Jump Brass
383	Soft Brass Section 2	Soft Brass 2
384	BigBand 1	BigBand 1
385	Solo Brass 1	Solo Brass 1

386	Bright Brass Section 3	Bright Brass 3
387	Synth Brass 3	Synth Brass 3
388	Solo Brass 2	Solo Brass 2
389	Soft Brass Section 3	Soft Brass 3
390	BigBand 2	BigBand 2
391	Synth Brass 4	Synth Brass 4
392	Brass Hit	Brass Hit
393	Analog Synth Brass 1	Ana Syn Br 1
394	Solo Brass 3	Solo Brass 3
395	Solo Brass 4	Solo Brass 4
396	Analog Synth Brass 2	Ana Syn Br 2
397	Funky Synth Brass 1	Funky Syn Br 1
398	Echo Brass	Echo Brass
399	Analog Synth Brass 3	Ana Syn Br 3
400	Soft Synth Brass	Soft Syn Br
401	Funky Synth Brass 2	Funky Syn Br 2
402	Tenor Sax 1	Tenor Sax 1
403	Alto Sax 1	Alto Sax 1
404	Soprano Sax 1	Soprano Sax 1
405	Baritone Sax 1	Baritone Sax 1
406	Sax Band 1	Sax Band 1
407	Sax Band 2	Sax Band 2
408	Sax & Clarinet	Sax & Clarinet
409	Sax Live 1	Sax Live 1
410	Sax Live 2	Sax Live 2
411	Soprano Sax 2	Soprano Sax 2
412	Tenor Sax 2	Tenor Sax 2
413	Alto Sax 2	Alto Sax 2
414	Baritone Sax 2	Baritone Sax 2
415	Slow Tenor Sax	Slow Tenor Sax
416	Soft Sax Band	Soft Sax Band
417	Super Sax Band	Super Sax Band
Flute & Wood Wind		
418	Flute 1	Flute 1
419	Clarinet 1	Clarinet 1
420	Pan Flute 1	Pan Flute 1
421	Oboe 1	Oboe 1
422	Flute & Sax	Flute & Sax
423	English Horn	English Horn
424	Bassoon	Bassoon
425	Sweet Flute	Sweet Flute
426	Piccolo	Piccolo
427	Clarinet & Sax	Clarinet & Sax
428	Sweet Pan Flute	Sweet Pan Flute
429	Shakuhachi	Shakuhachi
430	Clarinet 2	Clarinet 2
431	Flute 2	Flute 2
432	Pan Flute 2	Pan Flute 2
433	Oboe 2	Oboe 2
434	Whistle	Whistle
435	Recorder	Recorder
436	Blown Bottle	Blown Bottle
437	Ocarina	Ocarina
438	Dark Piccolo	Dark Piccolo
439	Bright Piccolo	Bright Piccolo
440	Chorus Piccolo	Chorus Piccolo

Voice List

441	Warm Piccolo	Warm Piccolo
442	Slow Piccolo	Slow Piccolo
443	Dark Flute	Dark Flute
444	Bright Flute	Bright Flute
445	Chorus Flute	Chorus Flute
446	Warm Flute	Warm Flute
447	Slow Flute	Slow Flute
448	Dark Pan Flute	Dark Pan Flute
449	Bright Pan Flute	Bright Pan Flute
450	Warm Pan Flute	Warm Pan Flute
451	Chorus Pan Flute	Chorus Pan Flute
452	Whistle & Pan Flute	Whistle & PanFlu
453	Dark Blown Bottle	Dk Blown Bottle
454	Bright Blown Bottle	Brt Blown Bottle
455	Chorus Blown Bottle	Cho Blown Bottle
456	Warm Blown Bottle	Warm Blow Bottle
457	Slow Blown Bottle	Slow Blow Bottle
458	Dark Shakuhachi	Dark Shakuhachi
459	Bright Shakuhachi	Bright Shaku
460	Chorus Shakuhachi	Chorus Shaku
461	Warm Shakuhachi	Warm Shaku
462	Slow Shakuhachi	Slow Shakuhachi
Lead & Pad		
463	Sine Solo 1	Sine Solo 1
464	Sine Solo 2	Sine Solo 2
465	Corrie 1	Corrie 1
466	Wire Lead 1	Wire Lead 1
467	Wire Lead 2	Wire Lead 2
468	Big Lead 1	Big Lead 1
469	Wavy Sawtooth 1	Wavy Sawtooth 1
470	Bauble Lead	Bauble Lead
471	Super Analog	Super Analog
472	Big Lead 2	Big Lead 2
473	Wire Lead 3	Wire Lead 3
474	Massiness 1	Massiness 1
475	Massiness 2	Massiness 2
476	2Oscillators Lead 1	2Oscillator Ld 1
477	2Oscillators Lead 2	2Oscillator Ld 2
478	Square	Square
479	Sawtooth	Sawtooth
480	Soft Big Lead 1	Soft Big Lead 1
481	Thick Saw 1	Thick Saw 1
482	Thick Saw 2	Thick Saw 2
483	Soft Sine 1	Soft Sine 1
484	Wah Lead 1	Wah Lead 1
485	Wah Lead 2	Wah Lead 2
486	Soft Wah Lead	Soft Wah Lead
487	Corrie 2	Corrie 2
488	Funky Lead	Funky Lead
489	Delayed Lead 1	Delayed Lead 1
490	Chiffer Lead	Chiffer Lead
491	Octave Lead	Octave Lead
492	Echo Drops 1	Echo Drops 1
493	SynCalliope Soft 1	SynCaliop Soft 1
494	Delayed Lead 2	Delayed Lead 2
495	Massiness 3	Massiness 3

496	EchoBell 1	EchoBell 1
497	SynCalliope Soft 2	SynCaliop Soft 2
498	Soft Sine 2	Soft Sine 2
499	Jazz Lead	Jazz Lead
500	Soft Big Lead 2	Soft Big Lead 2
501	EchoBell 2	EchoBell 2
502	Echo Crystal 1	Echo Crystal 1
503	EchoBell 3	EchoBell 3
504	Echo Crystal 2	Echo Crystal 2
505	Rising	Rising
506	Charang 1	Charang 1
507	Wavy Sawtooth 2	Wavy Sawtooth 2
508	Thick Square	Thick Square
509	Wah Sine Solo 1	Wah Sine Solo 1
510	TremoloMatrix	TremoloMatrix
511	DarkWire	DarkWire
512	ChorusHipLead 1	ChorusHip Lead 1
513	ChorusHipLead 2	ChorusHip Lead 2
514	TremoloBauble Lead	TreBauble Lead
515	ChorusSoftMini	ChorusSoftMini
516	Soft Trance Lead	SoftTraLead
517	Chiffe Fire Wire	ChiFireWire
518	Soft Analogon	Soft Analogon
519	CorrieCalliope 1	CorrieCalliope 1
520	WahCalliope	WahCalliope
521	BrightCalliope	BrightCalliope
522	AnalogonCalliope1	AlgnCalliope1
523	AnalogonCalliope2	AlgnCalliope2
524	Soft Chiffer Lead	Soft Chiffer Ld
525	Bright Chiffer Lead	Brt Chiffer Ld
526	Tremolo Chiffer Lead	Trem Chiffer Ld
527	TrumpSaw Chiffer Lead	TrpSaw Chiff Ld
528	Analogon Chiffer Lead	Ana Chiffer Ld
529	Soft Funky Lead 1	Soft Funky Ld 1
530	Soft Funky Lead 2	Soft Funky Ld 2
531	Wire Funky Lead	Wire Funky Lead
532	Soft Octave Lead	Soft Octave Lead
533	Bauble Octave Lead	Bauble Octave Ld
534	Bright Voice Lead	Bright Voice Ld
535	Soft Voice Lead	Soft Voice Lead
536	Delayed Voice Lead 1	Dely Voice Lead 1
537	Delayed Voice Lead 2	Dely Voice Lead 2
538	Funky Voice Lead 1	Funky Voice Ld 1
539	Soft Rising 1	Soft Rising 1
540	Soft Rising 2	Soft Rising 2
541	Bright Rising 1	Bright Rising 1
542	Bright Rising 2	Bright Rising 2
543	Wah Rising 1	Wah Rising 1
544	Soft Bass Lead 1	Soft Bass Lead 1
545	Soft Bass Lead 2	Soft Bass Lead 2
546	Voice Bass Lead	Voice Bass Lead
547	Bright Bass Lead 1	Bright Bass Ld 1
548	Calliope Bass Lead	Calliope Bass Ld
549	Bright Delayed Lead	Bright Delay Ld
550	Soft Cry Eyes 1	Soft Cry Eyes 1
551	Soft Cry Eyes 2	Soft Cry Eyes 2

Voice List

552	Bright Cry Eyes	Bright Cry Eyes
553	Square Cry Eyes	Square Cry Eyes
554	Soft Stardust 1	Soft Stardust 1
555	Soft Stardust 2	Soft Stardust 2
556	Bright Stardust 1	Brst Stardust 1
557	Bright Stardust 2	Brst Stardust 2
558	Wah Stardust 1	Wah Stardust 1
559	Space Voice 1	Space Voice 1
560	Vox Pad 1	Vox Pad 1
561	Vox Pad 2	Vox Pad 2
562	Vox Pad 3	Vox Pad 3
563	New Year Pad 1	New Year Pad 1
564	New Year Pad 2	New Year Pad 2
565	Soft Vox	Soft Vox
566	Space Voice 2	Space Voice 2
567	New Year Pad 3	New Year Pad 3
568	New Year Pad 4	New Year Pad 4
569	New Age Pad 1	New Age Pad 1
570	New Age Pad 2	New Age Pad 2
571	Soft Space Voice 1	Soft Space Vc 1
572	Bright Space Voice 1	Brst Space Vc 1
573	Bright Vox	Bright Vox
574	Bright Space Voice 2	Brst Space Vc 2
575	Soft Space Voice 2	Soft Space Vc 2
576	Choir&Organ	Choir&Organ
577	New Age Pad 3	New Age Pad 3
578	New Age Pad 4	New Age Pad 4
579	Warm Pad 1	Warm Pad 1
580	PWM Pad	PWM Pad
581	Warmly Pad 1	Warmly Pad 1
582	Warm Pad 2	Warm Pad 2
583	Sine Pad 1	Sine Pad 1
584	Warm Pad 3	Warm Pad 3
585	Sweep Pad 1	Sweep Pad 1
586	Poly Synth 1	Poly Synth 1
587	Dipolar Pad	Dipolar Pad
588	Poly Synth 2	Poly Synth 2
589	Poly Synth 3	Poly Synth 3
590	New Age Pad 3	New Age Pad 3
591	Horn Pad	Horn Pad
592	Metallic Pad 1	Metallic Pad 1
593	Metallic Pad 2	Metallic Pad 2
594	Pan Pad 1	Pan Pad 1
595	Congregate	Congregate
596	Pan Pad 2	Pan Pad 2
597	Pan Pad 3	Pan Pad 3
598	New Age Pad 4	New Age Pad 4
599	Itopia Pad 1	Itopia Pad 1
600	Itopia Pad 2	Itopia Pad 2
601	Metallic Pad 3	Metallic Pad 3
602	Metallic&Itopia	Metallic&Itopia
603	Sine Pad 2	Sine Pad 2
604	Sweep Pad 2	Sweep Pad 2
605	Analog Pad 1	Analog Pad 1
606	Analog Pad 2	Analog Pad 2
607	Bowed Pad 1	Bowed Pad 1

608	New Age&Bowed Pad 1	NewAge&Bow Pd 1
609	New Age&Bowed Pad 2	NewAge&Bow Pd 2
610	Halo Pad 1	Halo Pad 1
611	Halo&Bowed Pad	Halo&Bowed Pad
612	Poly Pad	Poly Pad
613	Slow Warm Pad	Slow Warm Pad
614	Bright New Age Pad	Brst New Age Pd
615	Warmly New Age Pad1	Warm New Age Pd1
616	Metallic New Age Pad	Metal New Age Pd
617	New Age Tune Pad	New Age Tune Pad
618	Choir New Age Pad	Choir New Age Pd
619	Warmly Pad	Warmly Pad
620	Warmly Pad 2	Warmly Pad 2
621	BigBand Pad	BigBand Pad
622	Organ Pad	Organ Pad
623	12-String Guitar Pad	12-String Gt Pd
624	Soft PolySy Pad	Soft PolySy Pad
625	Bright PolySy Pad	Bright PolySy Pd
626	Wah PolySy Pad	Wah PolySy Pad
627	Vox PolySy Pad	Vox PolySy Pad
628	Calliope PolySy Pad	Callio PolySy Pd
629	Wah Space Voice 1	Wah Space Vc 1
630	Wah Space Voice 2	Wah Space Vc 2
631	Soft Itopia Pad 1	Soft Itopia Pd 1
632	Square Itopia Pad	Squar Itopia Pd
633	Bright Itopia Pad 1	Brst Itopia Pd 1
634	Bright Bowed Pad 1	Brst Bowed Pd 1
635	Soft Bowed Pad 1	Soft Bowed Pad 1
636	Wah Bowed Pad	Wah Bowed Pad
637	Corrie Bowed Pad	Corrie Bowed Pd
638	Congregate Bowed Pad	Cong Bowed Pd
639	Bright Metal Pad 1	Brst Metal Pd 1
640	Soft Metal Pad	Soft Metal Pad
641	Wah Metal Pad	Wah Metal Pad
642	Space Voice Metal Pad	Space Vc Met Pd
643	Modern Metal Pad	Modern Metal Pad
644	Bright Halo Pad	Bright Halo Pad
645	Soft Halo Pad	Soft Halo Pad
646	Wah Halo Pad	Wah Halo Pad
647	PWM Halo Pad	PWM Halo Pad
648	Soft Dipolar Pad	Soft Dipolar Pad
649	Wah Dipolar Pad	Wah Dipolar Pad
650	Vox Dipolar Pad	Vox Dipolar Pad
651	Metallic Dipolar Pad	Metal Dipolar Pd
Synth FX & Sound Effects		
652	Guitar Fret Noise	GtFret Noise
653	Guitar Cutting Noise	GtCutting Noise
654	Acoustic Bass String Slap	Bass String Slap
655	Breath Noise	Breath Noise
656	Flute Key Click	Flute Key Click
657	Seashore	Seashore
658	Rain	Rain
659	Thunder	Thunder
660	Wind 1	Wind 1
661	Stream	Stream
662	Bubble	Bubble

Voice List

663	Bird Tweet 1	Bird Tweet 1
664	Dog	Dog
665	Horse Gallop	Horse Gallop
666	Bird Tweet 2	Bird Tweet 2
667	Telephone Ring 1	Telephone Ring 1
668	Telephone Ring 2	Telephone Ring 2
669	Door Creaking	Door Creaking
670	Door	Door
671	Scratch	Scratch
672	Wind Chime	Wind Chime
673	Helicopter	Helicopter
674	Car Engine	Car Engine
675	Car Stop	Car Stop
676	Car Pass	Car Pass
677	Car Crash	Car Crash
678	Siren	Siren
679	Train	Train
680	Jetplane	Jetplane
681	Starship	Starship
682	Burst Noise	Burst Noise
683	Applause	Applause
684	Laughing	Laughing
685	Screaming	Screaming
686	Punch	Punch
687	Heart Beat	Heart Beat
688	Footsteps	Footsteps
689	Gunshot	Gunshot
690	Machine Gun	Machine Gun
691	Lasergun	Lasergun
692	Explosion	Explosion
Ethnic & Combined		
693	Fiddle	Fiddle
694	Sitar	Sitar
695	Hackbrett	Hackbrett
696	Banjo	Banjo
697	Shamisen	Shamisen
698	Koto	Koto
699	Kalimba	Kalimba
700	Shanai	Shanai
701	Bag Pipe	Bag Pipe
702	Stereo Piano & Strings	Piano&Strings
703	Stereo Piano & Calliope	Piano&Calliope
704	Stereo Piano & Sweep	Piano&Sweep
705	Honky Tonk Piano & Fifths	Honk&Fifths
706	Honky Tonk Piano & Sweep	Honk&Sweep
707	FM Electric Piano	FM E.Piano
708	Digital Piano	Digital Piano
709	E.Piano & Pad	E.Piano&Pad
710	E.Piano & Sweep	E.Piano&Sweep
Perc/Drum		
711	Vibraphone (wide) 1	Vibraphone/Wide 1
712	Rigid Vibraphone	Rigid Vibraphone
713	Vibraphone 1	Vibraphone 1
714	Steel Drums 1	Steel Drums 1
715	Celesta 1	Celesta 1
716	Vibraphone 2	Vibraphone 2

717	Vibraphone 3	Vibraphone 3
718	Music Box & Flute	Music Box&Flute
719	Marimba 1	Marimba 1
720	Xylophone 1	Xylophone 1
721	Steel Drums 2	Steel Drums 2
722	Celesta 2	Celesta 2
723	Glockenspiel 1	Glockenspiel 1
724	Music Box 1	Music Box 1
725	Tubular Bells 1	Tubular Bells 1
726	Church Bell 1	Church Bell 1
727	Carillon 1	Carillon 1
728	Dulcimer 1	Dulcimer 1
729	Timpani 1	Timpani 1
730	Taiko Drum	Taiko Drum
731	Concert Bass Drum	Concert Ba Drum
732	Melodic Tom 1	Melodic Tom 1
733	Melodic Tom 2	Melodic Tom 2
734	Synth Drum	Synth Drum
735	Rhythm Box Tom	Rhythm Box Tom
736	Electric Drum	Electric Drum
737	Reverse Cymbal	Reverse Cymbal
738	Standard Set 1	Standard Set 1
739	Standard Set 2	Standard Set 2
740	Jazz Set	Jazz Set
741	Brush Set	Brush Set
742	Dance Set 1	Dance Set 1
743	Room Set	Room Set
744	Power Set	Power Set
745	Electronic Set	Electronic Set
746	Analog Set	Analog Set
747	Dance Set 2	Dance Set 2
748	Orchestra Set	Orchestra Set
749	SFX Set	SFX Set
750	Studio Set	Studio Set

Style List

No.	English Name
8BEAT & 16BEAT	
1	8Beat Pop 1
2	Pop Rock 1
3	8Beat Rock
4	8Beat Ballad
5	Pop Jazz
6	8Beat 1
7	8Beat Pop 2
8	Pop Funk 1
9	Rhythm&Beat 1
10	8Beat Disco 1
11	Guitar Pop 1
12	Guitar Pop 2
13	8Beat 2
14	Sweet Beat
15	8Beat Dance
16	Pop Funk 2
17	8Beat 3
18	60's 8Beat
19	Rhythm&Beat 2
20	16Beat 1
21	16Beat Funk 1
22	16Beat Ballad 1
23	16Beat R&B
24	16Beat Pop 1
25	16Beat Funk 2
26	16Beat Dance
27	16Beat Pop 2
28	16Beat 2
29	16Beat Pop 3
30	16Beat Pop 4
31	16Beat Hot
32	16Beat Modern
33	16Beat Funk 3
34	16Beat 3
35	Cool Beat
36	16Beat Ballad 2
37	16Beat 4
38	Pop Shuffle
ROCK	
39	Blues Rock
40	Hard Rock
41	Rock
42	New Wave
43	80's metal
44	Ska
45	Pop Rock 2
46	Pop Rock 3
47	Standard Rock
48	Slow Rock
49	70's Rock&Roll
50	Folk Rock
51	Easy Rock
52	New Shuffle
53	Rock Hip Hop

54	Rock&Roll 1
55	Rock Shuffle
56	Rock&Roll 2
POP & BALLAD	
57	Sweet Ballad
58	Piano Ballad
59	BriPop 1
60	6-8Ballad
61	Unplugged
62	Pop Dance 1
63	Pop Fusion
64	Analog Night 1
65	6/8 Pop
66	Brit. Pop 2
67	Fusion Shuffle
68	Analog Night 2
69	Soft Beat
70	60's Pop
71	Sting Latin
72	R&B Ballad 1
73	Guitar Ballad
74	Ballad Rock
75	Piano Pop 1
76	Soft Ballad
77	Natural Ballad
78	Love Ballad
79	Easy Ballad
80	Miami Folk
81	Slow Ballad
82	Folk Ballad
83	Pop Ballad 1
84	Pop Ballad 2
85	New R&B Ballad
BALLROOM	
86	Tango 1
87	Spain Matador
88	Twist 1
89	Twist 2
90	Big Band Fox
91	Tango 2
92	Tango 3
93	Slow Fox
94	Slow Waltz 1
95	Swing Fox
96	Salsa 1
97	Pop Cha Cha
98	Cha Cha 1
99	Cha Cha 2
100	Beguine 1
101	Rumba 1
102	Samba 1
103	Samba 2
104	Jive
105	Fox Trot
DANCE	
106	Techno 1

Style List

107	Hip Hop 1
108	House 1
109	House 2
110	Pop Dance 2
111	Down Beat
112	Progressive House
113	Dubstep
114	Techno 2
115	Rap 1
116	Soft Disco
117	Disco Party
118	70's Disco
119	Club Dance
120	Euro Dance
121	Hip Hop 2
122	Garage
SOUL & FUNK	
123	Pop funk
124	New R&B
125	Pop R&B
126	Neo-Soul
127	Funk 1
128	Jay R&B
129	Gospel Swing
130	Gospel
131	Funk 2
132	Electric Funk
133	Groove Funk
134	Rubber Funk
135	Jazz Funk
136	Soul
137	Hip Hop Soul
138	R&B
139	Soul Beat
140	R&B Ballad 2
141	British Soul Pop
SWING & JAZZ	
142	Modern Big Band
143	Gospel Swing
144	Piano Jazz
145	Smooth Jazz
146	Smooth Operator
147	Latin Jazz 1
148	Big Band
149	Dixieland 1
150	Broadway Big Band
151	Swing
152	Latin Jazz 2
153	Cool Jazz Ballad
154	Swing Shuffle
155	Big Band Medium
156	Dixieland 2
157	Acoustic Jazz
158	Guitar Swing 2
159	Ragtime
160	Modern Jazz Ballad
161	Swing Ballad

162	Orchestra Swing
COUNTRY	
163	Ballad Country 1
164	70's Country Rock
165	Ballad Country 2
166	Modern Country
167	Dixie Chicks
168	Country Pop 1
169	Bluegrass 1
170	Bluegrass 2
171	Modern Country
172	Country Pop 2
173	Country Pop 3
174	Bluegrass 3
175	2/4 Country
176	Country Quick Steps
177	Country Folk
178	Country Shuffle
LATIN & LATIN DANCE	
179	Bossa Nova
180	Latin
181	New Reggae
182	Reggae Dance
183	Lite Bossa
184	Latin Rock
185	Beguine 3
186	Slow Bolero
187	Disco Samba
188	Mambo
189	Meneito
190	Rumba 2
191	Rumba 3
192	Tikitikita
193	Lambada
194	Pop Cha Cha 1
195	Pop Cha Cha 2
196	Salsa 2
WALTZ & TRADITIONAL	
197	Waltz
198	English Waltz
199	German Waltz
200	Italian Mazurka
201	Mexico Waltz
202	Vienna Waltz
203	Slow Waltz 2
204	Polka
205	6/8 March
206	German Polka
207	Party Polka
208	March
209	French Musette
210	Mazurka
WORLD	
211	Enka Ballad
212	Laendler
213	Hawaiian
214	Sirtake

215	Dangdut
216	6/8 Flipper
217	New Age
218	Tarantella
219	Scottish
220	Norteno
PIANIST	
221	Pianist 1
222	Pianist 2
223	Pianist 3
224	Jazz 1
225	Jazz 2
226	Jazz Pub
227	Piano Rock
228	Pop Bossa
229	March 1
230	March 2
231	Piano Beat
232	Piano Bar
233	Blues
234	Pop Waltz
235	Slow Waltz
236	Ballad 1
237	Ballad 2
238	6/8 Ballad
239	Pop 1
240	Pop 2

Song List

No.	English Name	LCD Name
FOLK & COUNTRY		
1	Red River Valley	Red River Valley
2	Troika	Troika
3	Oh! Susanna!	Oh! Susanna!
4	Wave Of The Danube	Wave of Danube
5	Long Long Ago	Long Long Ago
6	Old Folks at Home	Old Folks at Home
7	Jambalaya	Jambalaya
8	Ding! Dong! Merrily On High	Ding! Dong!
9	Battle Hymn Of The Republic	Battle Hymn
10	The Old Gray Mare	The Old Gray Mare
11	American Patrol	American Patrol
12	Christmas Is Coming	Christmas Coming
13	Sippin' Cider Through A Straw	Sipping Cider
14	Christmas Sound	Christmas Sound
15	On London Bridge	On London Bridge
GOLDEN & POP		
16	House Of The Rising Sun	House of Rising
17	The Blue Bells Of Scotland	The Blue Bells
18	Beautiful Dreamer	Beautiful Dreamer
19	It's Been A Long, Long Time	Been a Long Time
20	O Sole Mio	O Sole Mio
21	Der Deitcher's Dog	Der Deitcher's Dog
22	Joy To The World	Joy to the World
23	Silent Night	Silent Night
24	Ave Maria	Ave Maria
25	Five Hundred Miles	Five Hundred Mil
26	Happy New Year	Happy New Year
27	It's Beginning To Look A Lot Like Christmas	Like Christmas
28	Jeanie With The Light Brown Hair	Jeanie
29	Music Box Dancer	Music Box Dancer
30	Go Tell It On The Mountain	Tell it on Mountain
31	Entertainer	Entertainer
32	Annie Laurie	Annie Laurie
33	Rumba Romance	Rumba Romance
34	The Last Rose Of Summer	Rose of Summer
35	The Old King Cole	The Old King Cole
JAZZ & FUSION		
36	Samba In June	Samba in June
37	Funk	Funk
38	I Can...	I Can...
39	Sea Shore	Sea Shore
40	Guitar&Saxphone	Guitar&Saxphone
41	The Hip Hop's Night	HipHop's Night
42	Blue Lunch	Blue Lunch
43	Cobweb	Cobweb
44	Wine	Wine
45	Jazz Old Man	Jazz Old Man
46	Dark Eyes	Dark Eyes
47	Carlos	Carlos
48	Sad	Sad
PIANO		
49	Lyrical Rondo	Lyrical Rondo
50	Rialto Ripples (Rag)	Rialto Ripples (Rag)
51	Neapolitan Song	Neapolitan Song
52	Waltzes	Waltzes
53	Turkish March	Turkish March
54	Schos Doll's Dance No. 2	Doll's Dance No.2

55	Minuet In D Major	Minuet in D Major
56	Inquietude	Inquietude
57	Italian Polka	Italian Polka
58	Moment Musical	Moment Musical
59	Prelude In C - Sharp Major	Prelude in C - Sharp Maj
60	The Happy Farmer	The Happy Farmer
61	The Rag - Time Dance	The Rag - Time Dance
62	Piano Sonata In C Major, K.330. III	Sonata K.330.III
63	Mazurka	Mazurka
64	Prelude In E Major	Prelude in E Major
65	Piano Sonata In A Major, K.331. I	Sonata K.331.I
66	Waltz For Piano In g - Sharp Minor	Waltz in g - Sharp
67	Gavotte	Gavotte
68	L' Arabesque	L' Arabesque
69	Austria Variation	Austria Variation
70	Schos Doll's Dance No. 7	Doll's Dance No.7
71	To A Wild Rose	To a Wild Rose
72	Gavotte I	Gavotte I
73	Waltz	Waltz
74	Minuet In G Major (BWV Anh. 116)	Minuet in G 2
75	Innocence	Innocence
76	Tchaikovsky Waltz	Tchaikovsky Waltz
77	Salut d' Amour	Salut d' Amour
78	Barcarolle	Barcarolle
79	Robot Doll	Robot Doll
80	Consolation	Consolation
81	2 - Part Invention #13 In A Minor.B.W. Iii	Invention A 2 Voix
82	Minuet In G Major (BWV Anh. 114)	Minuet in G 1
83	Barcarolle	Barcarolle
84	Norwegian Dance No.2	Norwegian Dance No.2
85	Moseta Dance	Moseta Dance
86	The Small Gathering	The Small Gathering
87	The Return	The Return
88	The Wagtail	The Wagtail
89	Bulie Dance	Bulie Dance
90	Tender Blossom	Tender Blossom

Demo List

No.	English Name	LCD Name
1	Demo1	Demo1
2	Demo2	Demo2
3	Demo3	Demo3

Chord List

Chord Name (Abbreviation)	Normal Voicing	Chord	Display
Major [M]	1-3-5	C	C
Major sixth [6]	1-(3)-5-6	C6	C6
Major seventh [M7]	1-3-(5)-7	CM7	CM7
Major seventh sharp eleventh [M7#11]	1-(2)-3-#4-(5)-7	CM7#11	CM7#11
Major add ninth [Madd9]	1-2-3-5	Cmadd9	CM(9)
Major ninth [M9]	1-2-3-(5)-7	CM9	CM7(9)
Major sixth add ninth [6 9]	1-2-3-(5)-6	C6 9	C6(9)
Augmented [aug]	1-3-#5	Caug	Caug
Minor [m]	1-b3-5	Cm	Cm
Minor sixth [m6]	1-b3-5-6	Cm6	Cm6
Minor seventh [m7]	1-b3-(5)-b7	Cm7	Cm7
Minor seventh flatted fifth [m7b5]	1-b3-b5-b7	Cm7b5	Cm7b5
Minor add ninth [madd9]	1-2-b3-5	Cmadd9	Cm(9)
Minor ninth [m9]	1-2-b3-(5)-b7	Cm9	Cm7(9)
Minor eleventh [m11]	1-(2)-b3-4-5-(b7)	Cm11	Cm7(11)
Minor major ninth [mM7]	1-b3-(5)-7	CmM7	CmM7
Minor major ninth [mM9]	1-2-b3-(5)-7	CmM9	CmM7(9)
Diminished [dim]	1-b3-b5	Cdim	Cdim
Diminished seventh [dim7]	1-b3-b5-6	Cdim7	Cdim7
Seventh [7]	1-3-(5)-b7	C7	C7
Seventh suspended fourth [7sus4]	1-4-5-b7	C7sus4	C7sus4
Seventh flatted fifth [7b5]	1-3-b5-b7	C7b5	C7b5
Seventh ninth [7 9]	1-2-3-(5)-b7	C7 9	C7(9)
Seventh sharp eleventh [7#11]	1-2-3-#4-(5)-b7 or 1-(2)-3-#4-5-b7	C7#11	C7(#11)
Seventh thirteenth [7 13]	1- 3-(5)-6-b7 or 2- 3-5-6-b7	C7 13	C7(13)
Seventh flatted ninth [7b9]	1-b2-3-(5)-b7	C7b9	C7(b9)
Seventh flatted thirteenth [7b13]	1-3-5-b6-b7	C7b13	C7(b13)
Seventh sharp ninth [7#9]	(1)-#2-3-(5)-b7	C7#9	C7(#9)
Major seventh augmented [M7aug]	1-3-#5-7	CM7aug	CM7aug
Seventh augmented [7aug]	(1)-3-#5-b7	C7aug	C7aug
Suspended fourth [sus4]	1-4-5	Csus4	Csus4
One plus two plus five [1+2+5]	1-2-5	C1+2+5	C

MIDI Implementation Chart

Function		Transmitted	Recognized	Remarks
Basic	Default	1ch	ALL	
Channel	Changed	1-16ch	1-16ch	
Mode	Default	x	3	
	Messages	x	3	
	Altered	*****	x	
Note	Note	0—127	0—127	
Number	:True voice	*****	0—127	
Velocity	Note on	o 9nH,V=1-127	o 9nH,V=1-127	
	Note off	x (9nH,V=0)	o(9nH,V=0; 8nH,V=0-127)	
After	key's	x	x	
Touch	Ch's	x	x	
Pitch Bend		x	o	
Control Change	0	o	o	Bank Select
	1	x	o	Modulation
	5	x	o	Portamento Time
	6	o	o	Data Entry
	7	o	o	Volume
	10	x	o	Pan
	11	x	o	Expression
	64	o	o	Sustain Pedal
	65	x	o	Portamento ON/OFF
	66	o	o	Sostenuto Pedal
	67	o	o	Soft Pedal
	80	x	x	Reverb Program
	81	x	x	Chorus Program
	91	o	o	Reverb Level
	93	o	o	Chorus Level
120	x	o	All Sound Off	
121	x	x	Reset All Controllers	
123	o	o	All Notes Off	
Program		o	o	
Change	:true	*****	0—127	
System Exclusive		x	o	
System	:SongPosition	x	x	
Common	:Song Select	x	x	
	:Tune	x	x	
System	:Clock	o	x	
Real Time	:Commands	x	x	
Aux	:LOCAL ON/OFF	x	x	
Messages	:Active sense	o	o	
	:Reset	x	o	
Notes:				

- Mode 1: OMNI ON, POLY
- Mode 2: OMNI ON, MONO

- Mode 3: OMNI OFF, POLY
- Mode 4: OMNI OFF, MONO

- o: YES
- x: NO

