

STAGE PIANO

Owner's Manual

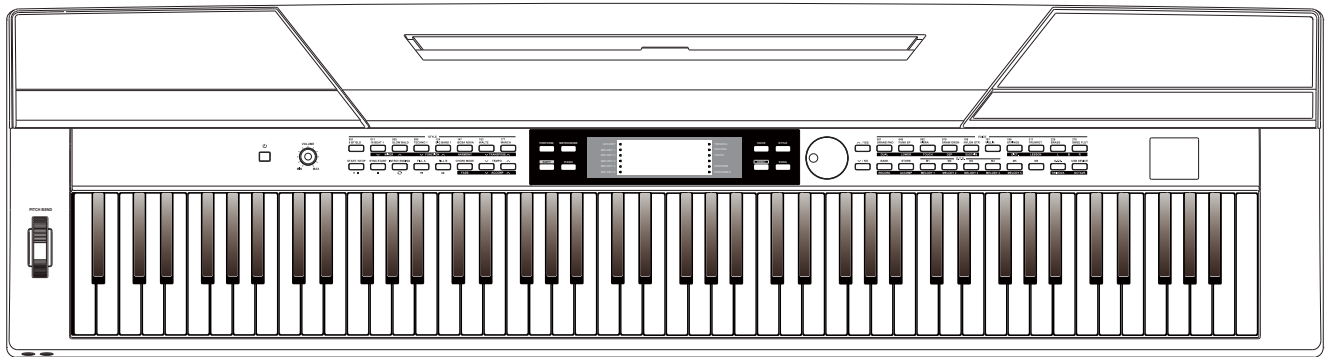

INFORMATION FOR YOUR SAFETY!

THE FCC REGULATION WARNING (for USA)

This equipment has been tested and found to comply with the limits for a Class B digital device, pursuant to Part 15 of the FCC Rules.

These limits are designed to provide reasonable protection against harmful interference in a residential installation. This equipment generates, uses, and can radiate radio frequency energy and, if not installed and used in accordance with the instructions, may cause harmful interference to radio communications. However, there is no guarantee that interference will not occur in a particular installation. If this equipment does cause harmful interference to radio or television reception, which can be determined by turning the equipment off and on, the user is encouraged to try to correct the interference by one or more of the following measures:

- Reorient or relocate the receiving antenna.
Increase the separation between the equipment and receiver.
- Connect the equipment into an outlet on a circuit different from that to which the receiver is connected.
- Consult the dealer or an experienced radio/TV technician for help.

Unauthorized changes or modification to this system can void the user's authority to operate this equipment.

CAUTION

The normal function of the product may be disturbed by Strong Electro Magnetic Interference. If so, simply reset the product to resume normal operation by following the owner's manual. In case the function could not resume, please use the product in other location.

PRECAUTIONS

PLEASE READ CAREFULLY BEFORE PROCEEDING

Please keep this manual in a safe place for future reference.

Power Supply

Please connect the designated AC adaptor to an AC outlet of the correct voltage.

Do not connect it to an AC outlet of voltage other than that for which your instrument is intended.

Unplug the AC power adaptor when not using the instrument, or during electrical storms.

Connections

Before connecting the instrument to other devices, turn off the power to all units. This will help prevent malfunction and / or damage to other devices.

Location

Do not expose the instrument to the following conditions to avoid deformation, discoloration, or more serious damage:

- Direct sunlight
- Extreme temperature or humidity
- Excessive dusty or dirty location
- Strong vibrations or shocks
- Close to magnetic fields

Interference with other electrical devices

Radios and televisions placed nearby may experience reception interference. Operate this unit at a suitable distance from radios and televisions.

Cleaning

Clean only with a soft, dry cloth.

Do not use paint thinners, solvents, cleaning fluids, or chemical-impregnated wiping cloths.

Handling

Do not apply excessive force to the switches or controls.

Do not let paper, metallic, or other objects into the instrument. If this happens, remove the electric plug from the outlet. Then have the instrument inspected by qualified service personnel.

Disconnect all cables before moving the instrument.

Contents

Panel Description

Front Panel.....	4
Rear Panel.....	4
LCD Display.....	5

Setup

Setting a Music Stand.....	6
Power Supply.....	6

Connections

Connecting a pair of Headphones.....	7
Connecting an Audio Equipment.....	7
Connecting a MP3/CD Player.....	7
Connecting a PC or an MIDI Device.....	7
Connecting a Foot Switch.....	8
Connecting a Unit Pedal.....	8
Connecting a Microphone.....	8

Quick Start

Power Switch and Master Volume.....	9
Playing Demo Songs.....	9
Playing Voices.....	9
Playing Styles.....	10
Playing Songs.....	10
Record.....	10

Advanced Use

Playing Voices.....	11
Select and Play Main Voice.....	11
Playing Two Voices Simultaneously-DUAL.....	11
Playing Different Voices with Both Hands-LOWER.....	11
Touch Sensitivity.....	12
Sustain.....	12
Pitch Bend.....	12
Transpose.....	13
Piano mode.....	13

Twinova

Octave.....	14
-------------	----

Auto Accompaniment

Playing Auto Accompaniment(rhythm track only).....	15
Playing Auto Accompaniment(all tracks).....	15
Accompaniment Sections.....	15
Playing Different Accompaniment Sections.....	16
Accompaniment Volume Control.....	16
Chord Fingering.....	17
Tempo.....	18
Fade In/Out.....	18
Metronome.....	18
One Touch Setting.....	18

Mixer

.....	19
-------	----

Harmony

Harmony Switch.....	20
Playing with harmony effect.....	20

Performance Assistant

What's the Performance Assistant?.....	20
Enter the Performance Assistant.....	20
Guitar Mode.....	21
Playing in Guitar Mode.....	21
Piano Mode.....	22
Playing in Piano Mode.....	22
Exit the Performance Assistant.....	22

DSP

.....	23
-------	----

Pedal Function

.....	23
-------	----

Function Menu

Tune.....	24
Split Point.....	24
Beat Type.....	25
Pedal Type.....	25
EQ Type.....	25
Reverb Type.....	26
Reverb Level.....	26
Chorus Type.....	26
Chorus Level.....	27
Harmony Type.....	27
MIDI IN.....	28
MIDI OUT.....	28
Auto Power Off.....	28

Registration Memory

Registering the Panel Setting.....	29
Recalling the Registered Panel Settings.....	29
Selecting a Registration Bank.....	29

Record

Start Recording.....	30
Select a Track.....	30
Stop Recording.....	31
Playback Recording.....	31
Delete User Song.....	31

Song

Listening to the Songs.....	32
Song Control.....	32

Lesson Mode

Lesson 1.....	33
Lesson 2.....	33
Lesson 3.....	33

Chord Dictionary

DICT 1 (Chord Learning Mode).....	34
DICT 2 (Chord Examining Mode).....	34

Connecting a USB Device

USB Device Operation.....	35
Play.....	35
Load.....	35
Save.....	36
Delete.....	36
Format.....	37
Keyboard and ASCII Character Relative Table.....	37

MIDI Functions

What's MIDI?.....	38
Downloading Data from the PC.....	38

Restore Factory Setting

Restore Factory Setting.....	39
Restore the Registered Panel Settings.....	39
Delete User Songs.....	39

Troubleshooting

.....	39
-------	----

Specifications

.....	40
-------	----

Appendices

Voice List.....	41
Style List.....	47
Song List.....	49
Demo List.....	50
MIDI Implementation Chart.....	51

Panel Description

Front Panel

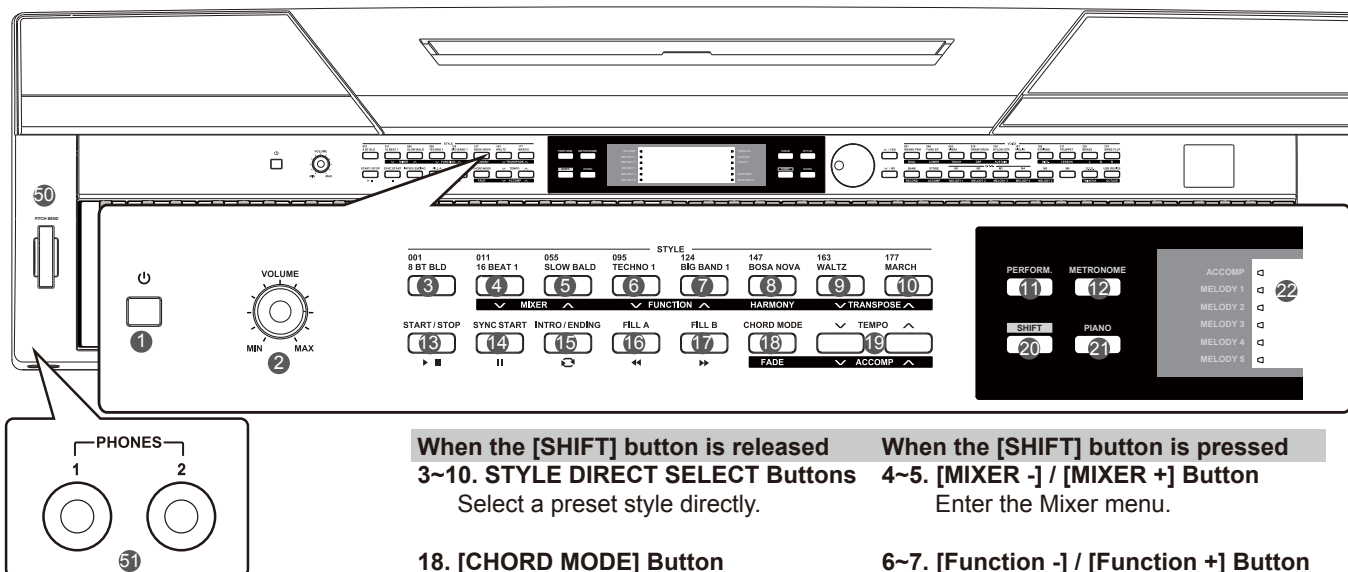

1. [POWER] Switch

Turn the power on or off.

2. [VOLUME] Knob

Adjust the master volume.

11. [PERFORM] Button

Turn the performance assistant function on or off.

12. [METRONOME] Button

Turn the metronome on or off.

13. [START/STOP] Button

Start/Stop playing the song or style.

14. [SYNC START] Button

Turn the Sync Start function on or off.

15. [INTRO/ ENDING] Button

Play the Intro or Ending.

16. [FILL A] Button

Fill-in variation A section.

17. [FILL B] Button

Fill-in variation B section.

20. [SHIFT] Button

Press and hold [SHIFT], then press other button enables you to execute various commands.

21. [PIANO] Button

Turn the piano mode on or off.

When the [SHIFT] button is released
3~10. STYLE DIRECT SELECT Buttons
 Select a preset style directly.

18. [CHORD MODE] Button

Choose the chord mode.

19. [TEMPO -] / [TEMPO +] Button

Adjust the current Tempo value.

22. LCD

Display all the parameters and values related to the currently selected operation and mode of the piano.

50. PITCH BEND

Roll the wheel upward or downward to raise or lower the pitch variations.

51. Phones

Connect stereo headphones with a 1/4" stereo phone plug.

When the [SHIFT] button is pressed
4~5. [MIXER -] / [MIXER +] Button
 Enter the Mixer menu.

6~7. [Function -] / [Function +] Button

Enter the Function menu.

8. [HARMONY] Button

Turn the Harmony effect on or off.

9~10. [TRANSPOSE -] / [TRANSPOSE +] Button

Enter the Transpose setting.

18. [FADE] Button

Turn the Fade In/Out function on or off.

19. [ACCOMP -] / [ACCOMP +] Button

Adjust the accompaniment volume value.

Rear Panel

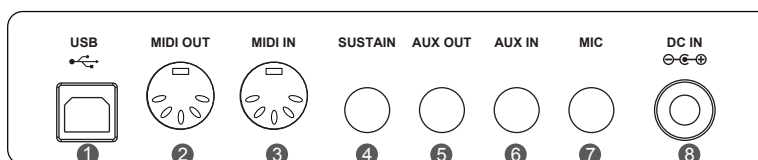

1. USB Terminal

Connect to a PC.

2. MIDI OUT Jack

Connect an external MIDI device.

3. MIDI IN Jack

Connect an external MIDI device.

4. SUSTAIN Jack

Connect a sustain pedal.

5. AUX OUT Jack

Connect the audio equipment.

6. AUX IN Jack

Connect some external audio source, such as MP3 or CD player.

7. MIC Jack

Connect a microphone with a 1/4" stereo phone plug.

8. DC 12V Jack

Connect the DC 12V power adapter.

Panel Description

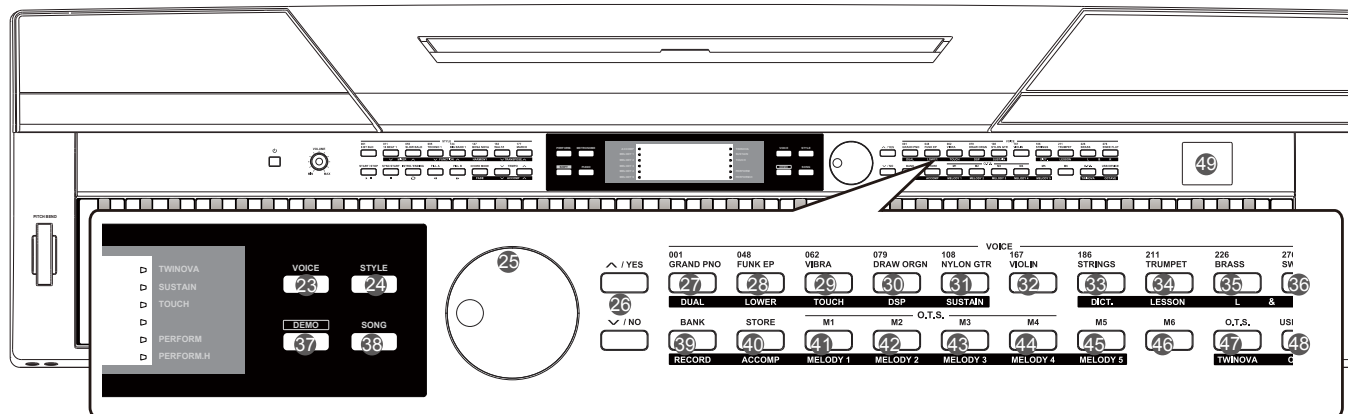

23. [VOICE] Button
Switch to voice mode.

24. [STYLE] Button
Switch to style mode.

25. DATA DIAL
Adjust the parameter value.

26. [+ / YES] / [- / NO] Button
Select operation of the parameter value currently.

37. [DEMO] Button
Start/Stop demo playback.

38. [SONG] Button
Enter the song mode.

49. USB Device
Connect to USB Device.

When the [SHIFT] button is released

27-36. VOICE DIRECT SELECT Buttons
Select a preset voice directly.

39. [BANK] Button
Switch between memory banks.

40. [STORE] Button
Save the registered panel settings.

41~46. [M1]~[M6] Buttons
Recall the registered panel settings. In O.T.S. mode, only M1-M4 are available.

47. [O.T.S.] Button
Turn the One Touch Setting function on or off.

48. [USB Device] Button
Enter the USB Device menu.

When the [SHIFT] button is pressed

27. [DUAL] Button
Turn the dual function on or off.

28. [LOWER] Button
Turn the lower function on or off.

29. [TOUCH] Button
Set an appropriate touch sensitivity level.

30. [DSP] Button
Turn the DSP function on or off.

31. [SUSTAIN] Button
Turn the sustain function on or off.

32. [DICT] Button
Turn the chord dictionary function on or off.

34. [LESSON] Button
Enter/Exit the lesson mode.

35. LEFT HAND Button
Choose the left hand in Lesson mode.

36. RIGHT HAND Button
Choose the right hand in Lesson mode.

39. [RECORD] Button
Enter the record mode.

40. [ACCOMP] Button
Select the accompaniment track to record.

41~45. MELODY 1-5 Button
Select the melody 1-5 track to record.

47. [TWINOVA] Button
Turn the TWINOVA function on or off.

48. [OCTAVE] Button
In TWINOVA mode, adjust the octave value.

LCD Display

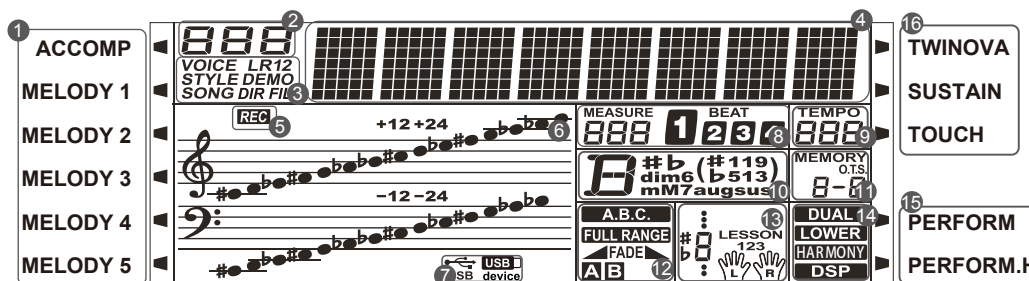

1. ACCOMP/ MELODY 1-5
2. SERIES NUMBER
3. VOICE/STYLE/DEMO/SONG/DIR/FILE
4. STRING
5. RECORD

6. TREBLE/BASS CLEF
7. USB CABLE/USB DEVICE
8. MEASURE/BEAT
9. TEMPO
10. CHORD

11. MEMORY NUMBER/ONE TOUCH SETTING
12. A.B.C./FULL RANGE/FADE/SECTION
13. NOTE INDICATION/LESSON
14. DUAL/LOWER/HARMONY/DSP
15. PERFORM/PERFORM.H
16. TWINOVA/SUSTAIN/TOUCH

Setup

Please use the specified AC adapter, 12V DC output, also pay attention to the polarity when connecting to one end of the AC adapter.

Note:

1. Never attempt to use an AC adapter other than the specified type, otherwise it may cause a fire or electrical shock.
2. For your safety, please disconnect the power when the piano is not used or during a thunderstorm.

Setting a Music Stand

Follow the image on the right, insert the bottom of the music stand into the groove on the top of the instrument's console.

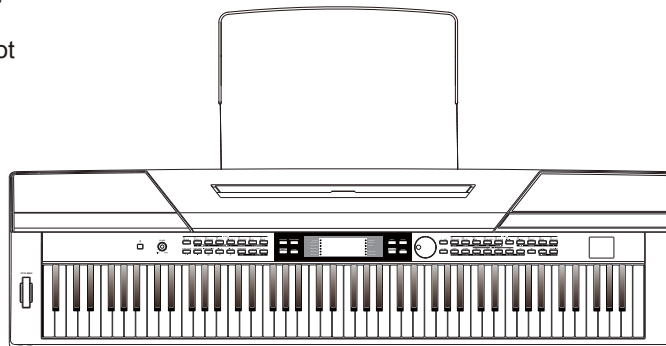

Power Supply

1. Turn down the volume of this instrument and all audio equipment connected.
2. Connect the power cable to the AC outlet.
3. Plug the AC adapter into the AC outlet.
4. Press the POWER switch, the LCD will display "Loading!", which indicates the piano has been powered on.
5. Press the [POWER] switch for a short while until the LCD off, which indicates the piano has been powered off.

Note:

1. The piano will shut down automatically in 30 minutes later if you do not take any action on the piano. Please refer to the "Auto Power Off" for details.
2. For your safety, please remove the electric plug from the outlet when the piano is not to be used for extended periods or during the thunderstorm.

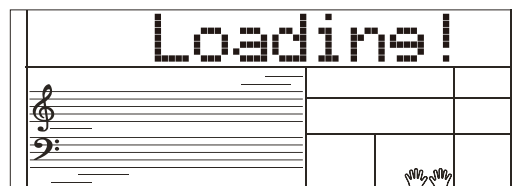
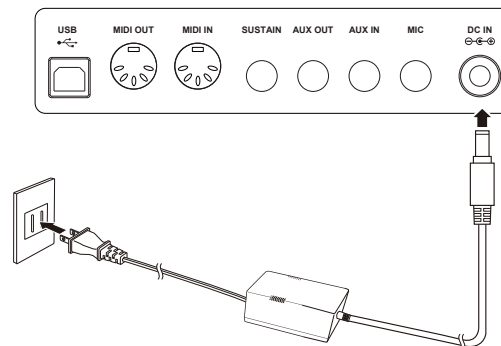
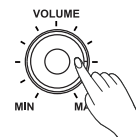

Connections

Connecting a pair of Headphones

A standard pair of stereo headphones can be plugged in here for private practice or late-night playing.

Jack 1: When a pair of headphones is plugged into the jack 1, the sound can be heard from both headphones and speakers of the instrument.

Jack 2: When a pair of headphones is plugged into the jack 2, the internal stereo speaker system is automatically shut off. The sound can only be heard from headphones.

Note:

Listening at excessively high volume levels will not only damage the headphones, but may also cause hearing loss. Use the headphones at a moderate volume level.

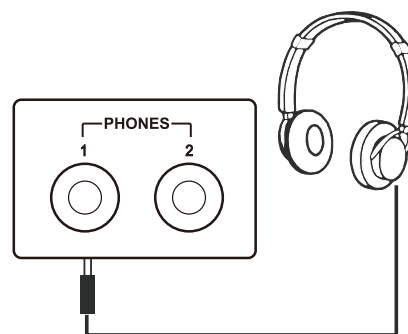

Connecting an Audio Equipment

The rear-panel AUX OUT jack delivers the output of the instrument for the connection to a keyboard amplifier, stereo sound system, a mixing console, or a tape recorder.

Use an audio cable to plug into the AUX OUT jack, which is located on the rear board then plug the other end of the cord into AUX IN of the amplifier.

Note:

To avoid damaging the speakers, please ensure that the volume has been set to the minimum level before connecting to the power and other devices.

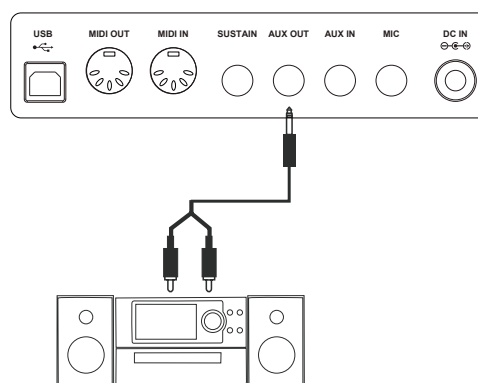

Connecting a MP3/CD Player

Connect the audio output of an MP3/CD player or other audio source to the stereo AUX IN jack on the rear panel.

The input signal is mixed with the piano signal so as to play along.

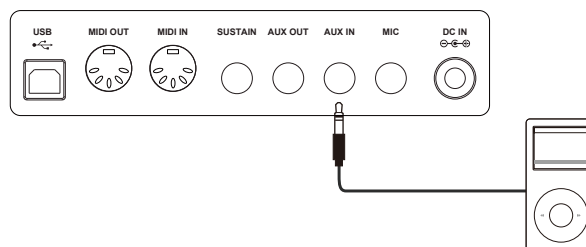

Connecting a PC or an MIDI Device

MIDI OUT Connector

Connect the instrument MIDI OUT terminal to the MIDI IN terminal of external device via the MIDI cables. All performance data will be transmitted from this connector to connected PC or MIDI devices.

This instrument will be used as the MIDI controller. Namely the external sound source can be used through this instrument.

MIDI IN Connector

Connect the MIDI IN terminal to PC or the MIDI OUT terminal of external device with MIDI cables. In order to be used as a sound source, all the performance data will be transmitted from other MIDI devices to the instrument.

USB Connector

By connecting the USB terminal to PC, the data will be transmitted between the instrument and the PC via the USB cables.

For example, you can save your instrument performance data in the PC and playback the saved MIDI file by piano.

Note:

Please do not set the USB audio to be input and output simultaneously when you are setting the software on the PC. Otherwise the sound will be overlapped when play the keyboard.

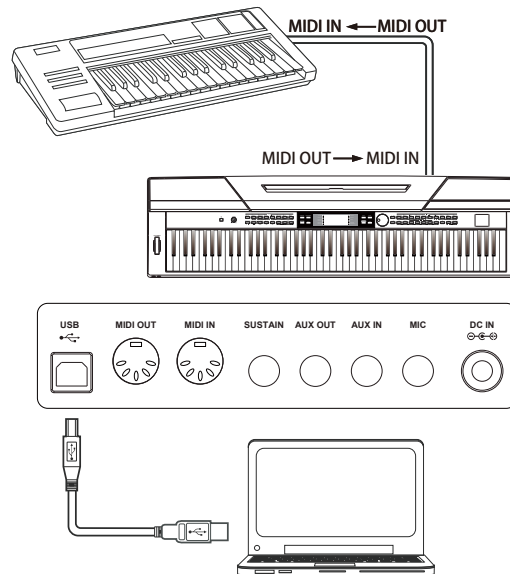

Connections

Connecting a Foot Switch

To achieve a natural effect, step on the sustain switch when playing. Plug an supplied foot switch into this jack and use it to switch sustain on or off.

You can assign other pedal functions to the sustain pedal. Please refer to the Function Menu for details.

Note:

1. This instrument supports not only the foot switch we supply, but also those with other brands.
2. Please make sure the power is off when connecting the pedal with other brands, otherwise the sequence of switch on/off will be reversed when turning the piano on.

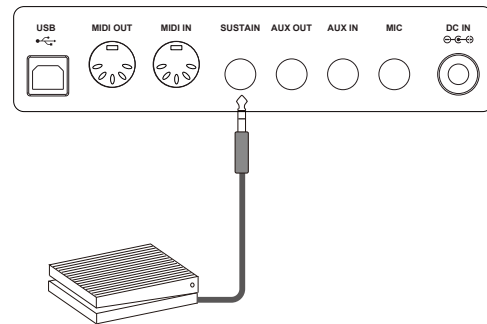

Connecting a Unit Pedal

To simulate a real piano, the unit pedal can be connected to the pedal terminal at the rear bottom of the piano.

It contains three functional pedals: Sustain, Sostenuto, Soft.

Sustain Pedal

Use this pedal to sustain the sound. It also supports the half-pedal operation. Performing with the sustain pedal will achieve a smoothly effect.

Sostenuto Pedal

This pedal sustains only the sounds of the keys that were already played when you pressed the pedal.

Soft Pedal

This pedal is used to make the sound softer. You can assign other pedal functions to the soft pedal. Please refer to the Function Menu for details.

Note:

The unit pedal needs to be purchased separately.

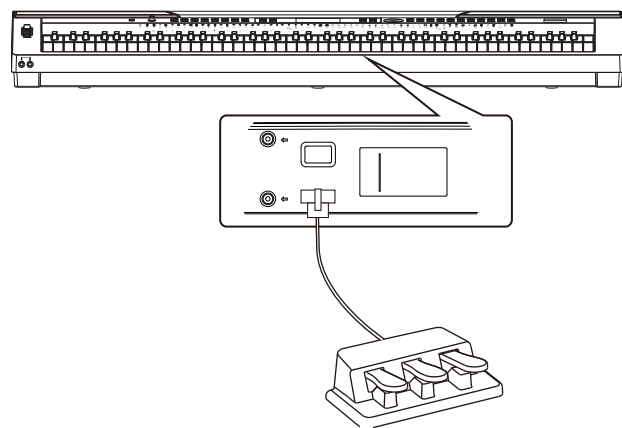

Connecting a Microphone

By connecting a microphone, you can enjoy singing along with your keyboard performance or with Song playback (KARAOKE).

1. Before turning the power on, set the master volume to minimal value.
2. Plug the microphone into the [MIC] jack at the rear of the instrument.
3. Turn the power on. Adjust the master volume value while singing through the microphone.

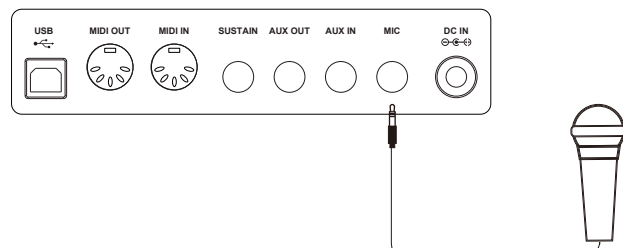

Quick Start

Power Switch and Master Volume

Power Switch

1. Please make sure you have connected the instrument with power correctly.
2. Press the [POWER] switch, the LCD screen lights up, and displays "Loading! ", it indicates the instrument is powered on.

Note:

Press the POWER switch, if the LCD screen does not light up, please check the power connection.

Adjust the Master Volume

After starting, rotate the [VOLUME] knob clockwise, the master volume will increase and vice versa . It can be adjusted as required.

Note:

If the keyboard is in silent, that means the volume has been adjusted to its minimum level or the jack 2 of headphone has been connected.

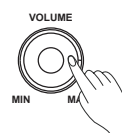
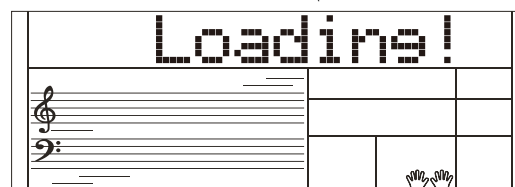
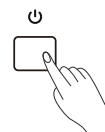

Playing Demo Songs

This instrument features 5 wonderful demos with different characters. (Please refer to the Demo List for details.)

1. Press the [DEMO] button
Enter the main interface of demo playing back, the LCD displays current demo number and name, meanwhile, all demo songs will play in circle.
2. Select Demo Songs
Use the data dial or the [+ / Yes] / [- / No] button to select a demo song.
3. Press the [START/STOP] button
Press the [DEMO] or [START/STOP] button to stop playing and exit demo mode.

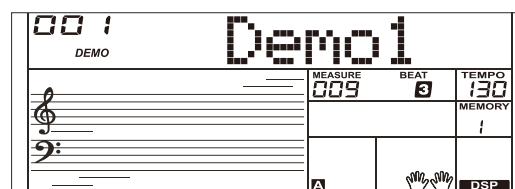
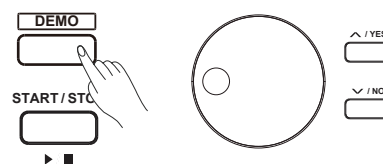

Playing Voices

The keyboard has 600 remarkably realistic built-in voices, including Piano, Guitar, Saxophone, Drum Kits and many more. Please refer to Voice List.

1. Press the [VOICE] button
Enter the Voice mode. The LCD displays the current default voice name and number.
2. Select a Voice.
Use the data dial or the [+ / Yes] / [- / No] button to select the voice you need. You can also use the voice direct buttons to select the desired voice.
3. Play the Voice.
Play the keyboard and listen to the wonderful voice.

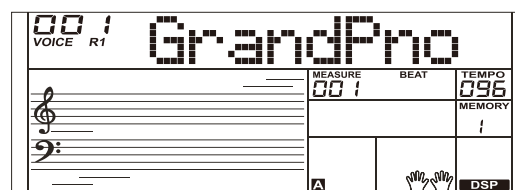

Quick Start

Playing Styles

The instrument features 230 styles in a variety of different musical genres, and 10 more user styles in addition to this. Try to select different styles and playing with the auto accompaniment. (Please refer to the Style List for details.)

1. Press the [STYLE] button
Enter the Style Mode. The LCD displays the current default style name and number.
2. Select a Style
Use the data dial or the [+/Yes]/ [-/No] button to select the style you need. You can also use the style direct buttons.
3. Play the Style.
Press the [START/STOP] button, directly start a rhythm playing.

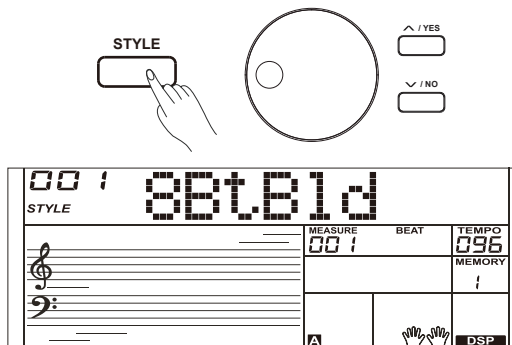

Playing Songs

This instrument features 120 preset songs, and 5 more user songs in addition to this. Each preset song can be practiced in learning mode.

1. Press the [SONG] button
Enter the song selection mode. It will play all songs in circle.
2. Select a song
Use the data dial or the [+YES]/ [-NO] button to select the song you want.
3. Press the [START/STOP] button, it will stop playing. Press the button again, it will play the selected song in circle.
4. When the song stops, press either [STYLE] or [VOICE] button to exit the song mode.

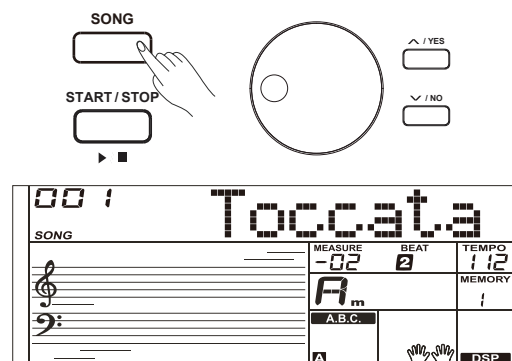

Record

This instrument can record up to 5 user songs.

1. Holding down the [SHIFT] button and press the [RECORD] button to enter the user song mode, use the data dial or the [+YES]/[-NO] button to select a user song to be saved.
2. Holding down the [SHIFT] button and press the [RECORD] button to enter the record standby mode, select the voice, style or other parameters to prepare for recording.
3. Press the [START/STOP] button or playing a key on the keyboard to start recording.
4. When recording is in process, holding down the [SHIFT] button and press the [RECORD] button, it will stop recording and exit the record mode, then the current recorded song will play automatically in circle.
5. Press the [SONG] button to select the user song:121~125 for playing back after exiting the record mode.

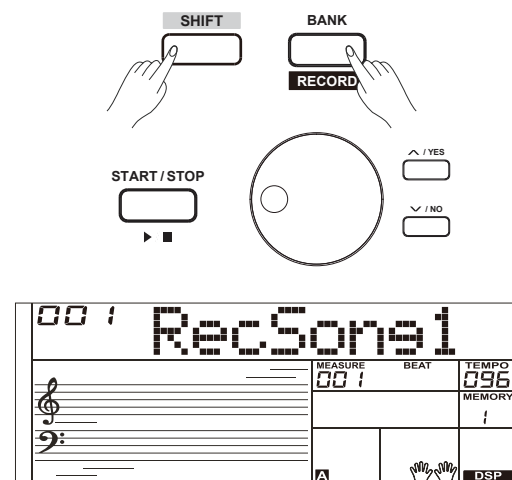

Advanced Use

Playing Voices

This instrument features 600 preset voices (Please refer to the Voice List for details). In order to offer you a better performance experience, we supply some useful effects which can be inserted while playing voices.

Select and Play Main Voice

1. Press the [VOICE] button or the voice direct button to enter the VOICE mode. The LCD displays "VOICE R1" and the current voice name and number.
2. Select a voice
Use the data dial, or the [+ / YES] / [- / NO] button to select the voice you want, also use the voice direct button.
3. Play the voice
You can play the keyboard and hear the wonderful voice.

Note:

When the DUAL and LOWER function is on, you can press [VOICE] button repeatedly to choose the voice source. The corresponding LCD indication will highlight between R1, R2, and L1.

Playing Two Voices Simultaneously-DUAL

This instrument supports dual function. This function allows two sounds to be layered together, creating a more rich sound. Once you turn the function on, the voice indicated "VOICE R2", when the dual function is off, the voice indicated "VOICE R1".

1. Holding down the [SHIFT] button and press the [DUAL] button to turn the dual function on. The LCD displays DUAL and VOICE 2 will light up, which indicates the name and number of DUAL.
2. Use the data dial or the [+ / YES] / [- / NO] button to select the dual voice you need, also use the voice direct buttons.
3. Play the keyboard, two different voices to be layered together will be heard simultaneously. It seems like two different instruments playing at the same time.
4. Holding down the [SHIFT] button and then press the [DUAL] button again to turn dual function off.

Note:

When the keyboard has been split, only the right hand area will respond to the dual voice, the left hand will not respond to it.

Playing Different Voices with Both Hands-LOWER

The lower function splits the keyboard into right and left areas to create two different voices. The left section voice is lower voice. A desired split point can be assigned on the keyboard.

1. Holding down the [SHIFT] button and press the [LOWER] button to turn LOWER function on. The LCD displays VOICE L and LOWER will light up, which indicates the name and the number of LOWER.
2. Use the [+ / YES] / [- / NO] or voice direct buttons to select the lower voice you want.
3. Play the keyboard.
Different voices will be heard between the right-hand and left-hand area.

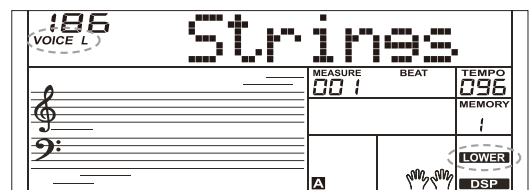
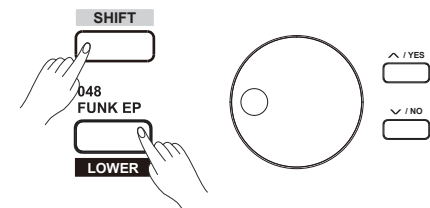
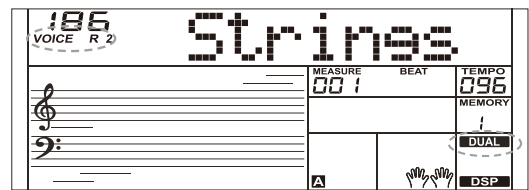
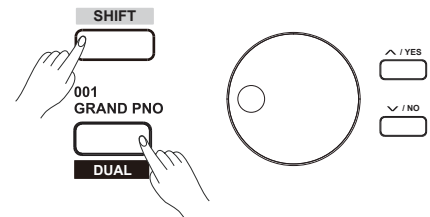
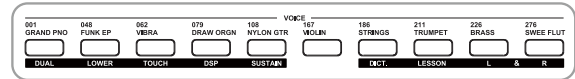
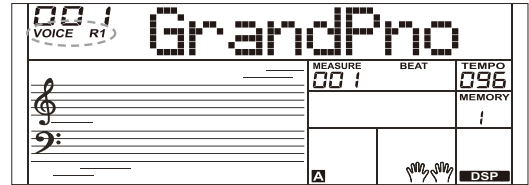
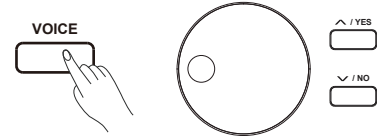

Advanced Use

- Holding down the [SHIFT] button and press the [LOWER] button again turns LOWER function off.

Split Point

The point on the keyboard which separates voice L and voice R1/R2 is called the “split point”. The split point is default set to F#3(34). However you can set the split point to any key you want. (Please refer to “Split Point Setting” part for details)

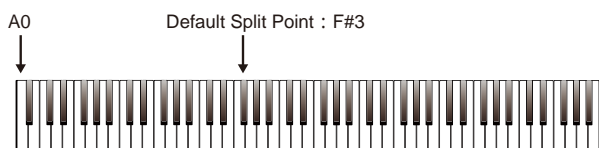

Touch Sensitivity

The instrument is equipped with a touch response feature which lets you dynamically and expressively control the level of the voice with your playing strength just as on an acoustic instrument. The instrument features 3 touch types to be chosen: off,1,2,3.

- Holding down the [SHIFT] button and press the [TOUCH] button to enter touch settings. The LCD displays the touch setting number. The default number is 2.
- Choose a touch type
When the LCD displays touch setting, using the[+ / YES] / [- / NO] button or data dial or while hold down the [SHIFT] button, press the [TOUCH] button to change touch type. Pressing the[+ / YES] and [- / NO] buttons simultaneously will restore the touch value to its default setting: 2.
- Turn the touch function off
If the LCD displays “OFF Touch”, that means no touch response on the keyboard.

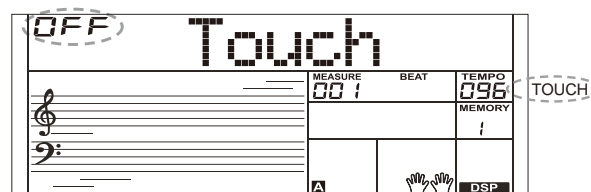
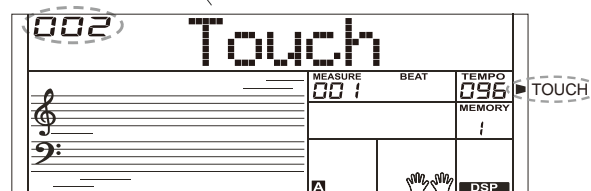
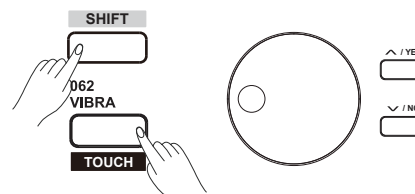

Sustain

- Holding down the [SHIFT] button and press the [SUSTAIN] button to turn sustain function on. All notes will sustain even after releasing the keys.
- Holding down the [SHIFT] button and press the [SUSTAIN] button again to exit the sustain function.

Note:

In order to achieve a natural sustain effect, use the sustain pedal.

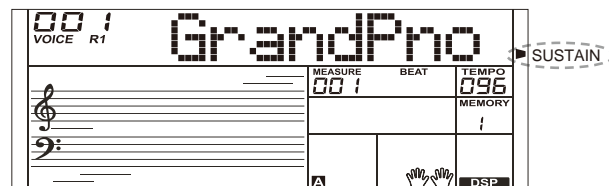
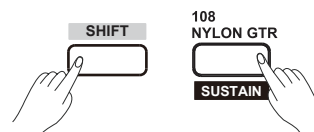

Pitch Bend

Use the pitch bend wheel to bend notes up (roll the wheel away from you) or down (roll the wheel toward you) while playing the keyboard. The pitch bend wheel is self-centering and will automatically return to normal pitch when released. Use the pitch bend wheel to imitate the guitar, violin, saxophone, urheen, suona and pitch bend effect of other instruments for making your performance more vivid.

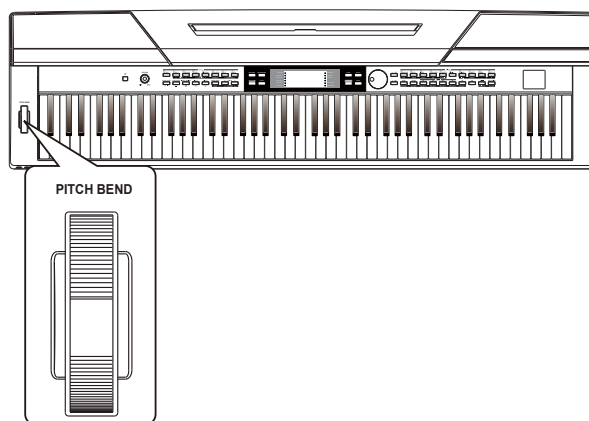

Advanced Use

Transpose

Transpose function allows the overall pitch of the instrument to be transposed up or down by a maximum of one octave in semitone increments.

1. Holding down the [SHIFT] button and press the [TRANSPOSE] button to enter transpose settings. LCD displays the current transpose: “***Transpos”.
2. When LCD displays “***Transpos”, use [TRANSPOSE-]/[TRANSPOSE+], [+YES]/[-NO] or data dial to change transpose value. The max range is ± 12 semitones.
3. Press the [+YES] / [-NO] buttons or [TRANSPOSE-] / [TRANSPOSE+] simultaneously to restore the transpose value to its default setting: “000Transpos”.

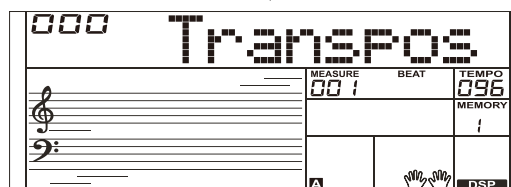
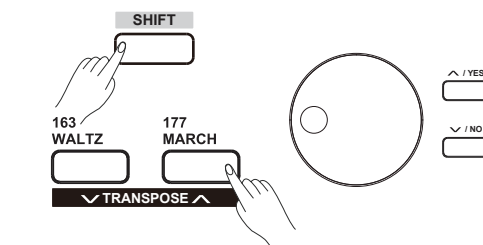

Notes:

1. Playing in G key, set the transpose to -05 or 007, and then you can play the G scale using C scale keys.
2. Transpose setting is applied to automatic chord accompaniment and full keyboard.

Piano mode

This function is to set the voice of the whole keyboard to the piano instantly.

1. Press the [PIANO] button to enter/exit piano mode.
2. In piano mode, the accompaniment control is the same to other mode. The accompaniment only plays the rhythm part.

Note:

In piano mode, the CHORD MODE function is automatically turned off.

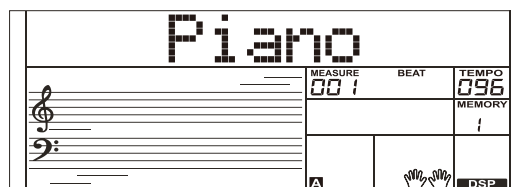
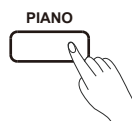

Twinova

In Twinova mode, the keyboard is divided into the right area and the left area which creates two parts with the same voice and pitch based on a split point for your convenience on one to one teaching.

1. Holding down the [SHIFT] button and then press the [TWINOVA] button to turn this function on. The "TWINOVA" icon lights up. At the same time, both DUAL and LOWER functions cannot be used under this mode. The default split point is E3 (32).
2. The main voice is the default one for either the right-hand part or the left-hand part before entering into the Twinova mode. Use the data dial or the [+ / YES] / [- / NO] button, to select the desired voice.
3. Holding down the [SHIFT] button, and then press the [TWINOVA] button again to turn off the Twinova function. The "TWINOVA" icon will be off.

Notes:

1. Twinova is unable to be used under the Songs/Demo playing mode.
2. To set the split point of Twinova, please refer to "Split Point Setting" part for details.
3. Octave is invalid unless in the Twinova mode. After adjusting the octave, some highest range or the lowest part of the voice may be silent.

Octave

This function can let the whole pitch of the keyboard raise or lower an octave. Only in the Twinova mode, the octave can be adjusted, and the octave in the same region of the keyboard is adjusted together. After exiting the Twinova mode, the keyboard will restore and is unable to be adjusted.

1. In the Twinova mode, holding down the [SHIFT] button and press the [OCTAVE] button, the LCD displays the current octave temporarily "xxx Octave". At this time, use the [+ / YES] / [- / NO] button or the data dial to change the octave value, the adjustable range is: -1~ +1. Press the [+ / YES] and [- / NO] buttons simultaneously to restore the octave value to its default setting: 000.
2. Without any operation within 5 seconds, the system will exit the Octave mode automatically.

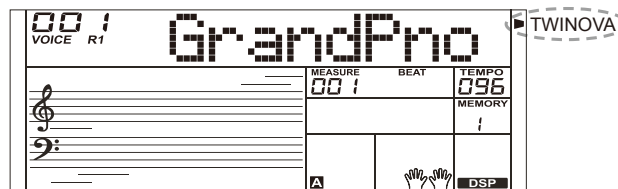
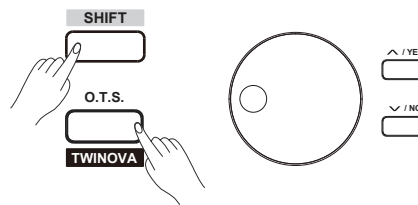

Default Split Point: E3

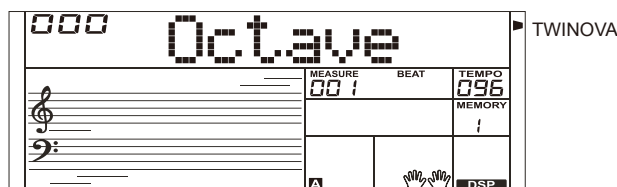
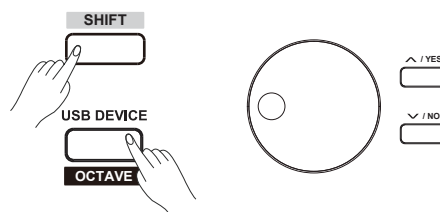
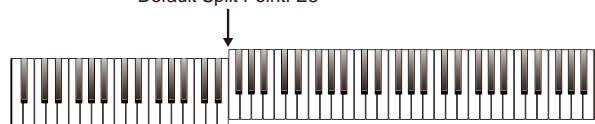

Auto Accompaniment

The auto accompaniment function puts a full backing band at your fingertips. All you have to do is to play the chords with your left hand using your selected accompaniment style, and then the accompaniment will automatically play along, instantly following the chords you play. This keyboard features 230 styles in a variety of different musical genres. Try to select and playing with the style you want . (Please refer to the Style List for details)

Playing Auto Accompaniment (rhythm track only)

1. Press the [STYLE] button
Enter the style mode. The "STYLE" icon on the left-top of the LCD will light up. The LCD displays the name and the number of the current style.
2. Select a style
Use the data dial or the [+ / YES] / [- / NO] button to select a style you want. Or use the style direct buttons.
3. Start playing a style
Press the [START / STOP] button to start the rhythm tracks of the auto accompaniment. Also press [SYNC START] and then play any key to start the rhythm tracks of the auto accompaniment.
4. Press the [START / STOP] again to stop style playing.

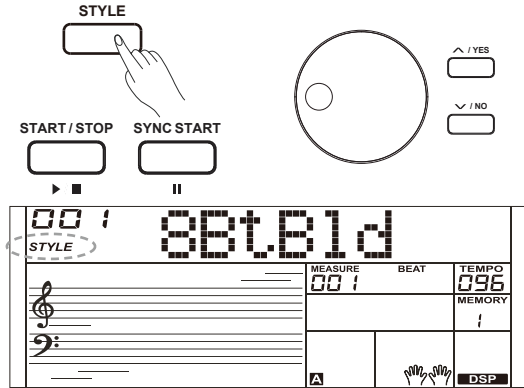

Playing Auto Accompaniment (all tracks)

1. Turn the auto accompaniment on
In style mode, press the [CHORD MODE] button to enter the "auto bass chord" (A.B.C.) mode. The keyboard is divided into two sections. Left-hand section is the chord detecting section. Meanwhile the "A.B.C." icon lights up. Now pressing any key in chord detect section (Sync Start status), the fantastic accompaniment will be heard. Press [CHORD MODE] button again to enter "full range" mode. The "FULL RANGE" icon will light up. The whole keyboard is chord detect section.
2. Start the auto accompaniment
Press the [SYNC START] button and then play a chord in chord detecting section to start the auto accompaniment of all tracks. The accompaniment automatically changes followed by the change of the chord. Press the [START / STOP] button to start the auto accompaniment of the rhythm track, then play a chord in chord detecting section. It will start the auto accompaniment of all tracks.

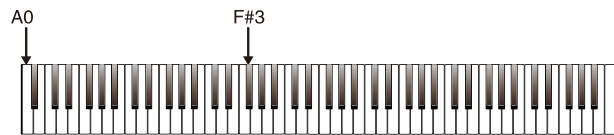
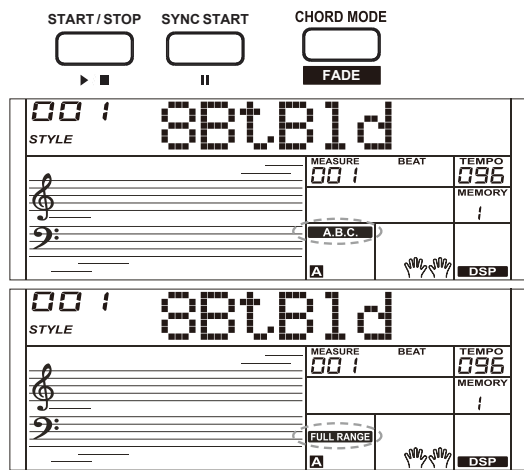

Note:

The instrument includes 10 user styles. You can use our PC suite to create your own styles.

Accompaniment Sections

A various types of Auto Accompaniment sections which allow you to vary the arrangement of the accompaniment to match the song playing.

They are: Intro, Main (A, B), Fill (A, B), and Ending. By switching among them during your performance, easily produce the dynamic elements of a professional sounding arrangement .

1. INTRO Section
The intro is an opening section of the song. When the intro pattern is finished, the system will automatically shift to the main section.
2. MAIN Section
The main is an important section of the song. And it plays an accompaniment pattern and repeat infinitely until another section's button is pressed.

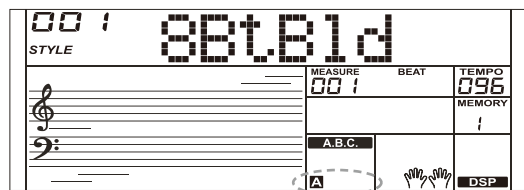
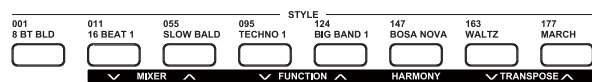

Auto Accompaniment

3. FILL-IN Section

Auto fill in function automatically adds a fill to your performance. When the fill-in is finished, accompaniment shifts to the Main section (A,B).

4. ENDING Section

Ending is used for the ending of the song. When the ending is finished, accompaniment automatically stops.

Notes:

1. Holding down the [FILL A]/ [FILL B] button when the style is playing, the selected fill-in pattern repeats continuously until button is released.
2. Press the [FILL A]/ [FILL B] button when style stops, it will change the preset main section. The "A" or "B" icon lights up.

Playing Different Accompaniment Sections

1. Press the [STYLE] button or [+ / YES] / [- / NO] button to select a style, also use the style direct buttons or data dial.
2. Press the [CHORD MODE] button to enter A.B.C. (auto bass chord) mode.
3. Press the [SYNC START] button to turn SYNC START on.
4. Press the [FILL A] button, select the Main A section.
5. Press the [INTRO/ENDING] button, the "A" icon flashes, and the style is ready to play.
6. It will start the accompaniment as soon as you start playing in Chord section. When the playback of the intro is finished, it automatically leads into Main A section.
7. Press the [FILL B] button plays an appropriate fill-in pattern to spice up the rhythm (the "B" icon flashes). When the fill in is completed, it leads smoothly into the main B section.
8. Press the [INTRO/ENDING] button again, and it will enter the ending section. When the ending is finished, the auto accompaniment automatically stops.

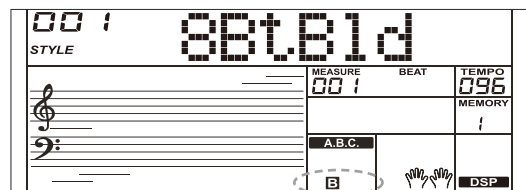
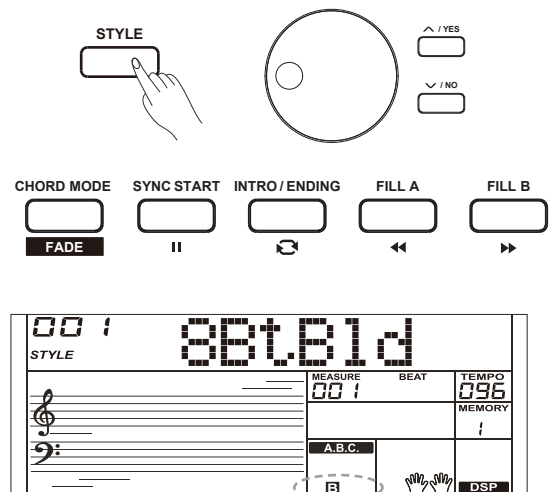

Accompaniment Volume Control

This function is used to adjust the volume of all tracks of accompaniment for balancing the volume between accompaniment part and keyboard voice.

1. Holding down the [SHIFT] button and use the [ACCOMP +] or [ACCOMP -] button to adjust accompaniment volume, adjustable range: 0~127, the LCD displays current accompaniment volume value.
2. Holding down the [SHIFT] button and then press the [ACCOMP +] and [ACCOMP -] button simultaneously to turn the accompaniment volume off. The LCD displays "OFF Accomp". Press the [ACCOMP +] and [ACCOMP -] button simultaneously again to turn the accompaniment volume on.

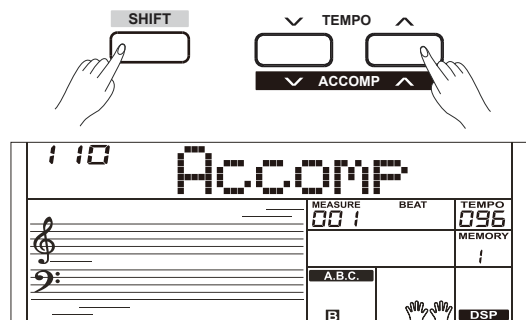

Auto Accompaniment

Chord Fingering

How the chords are played or indicated with your left hand (in the auto accompaniment section of the keyboard) is referred to as "fingering". There are 2 types of fingerings as described below.

Chord Basics

A chord, in music, is any harmonic set of three or more notes that is heard as if sounding simultaneously. The most frequently encountered chords are triads. A triad is a set of three notes that can be stacked in thirds. When stacked in thirds, the triad's members, from lowest pitched tone to highest, are called: the Root, the Third, and the Fifth.

Triad Type

There are following basic triad types:

Major Triad	A root with a major third added above and a perfect fifth will consist as a "Major Triad".
Minor Triad	A root with a minor third added above and a perfect fifth will consist as a "Minor Triad".
Augmented Triad	A root with a major third added above and an augmented fifth will consist as an "Augmented Triad".
Diminished Triad	A root with a minor third added above and a diminished fifth will consist as a "Diminished Triad".

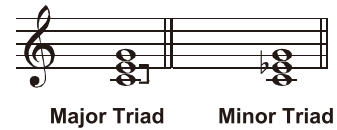
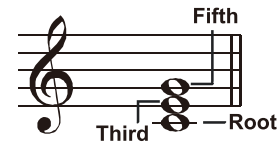

Root Position First Inversion Second Inversion

Cm

Chord Root Chord Type

Chord Inversion

We define this chord its root is not in the bass (i.e., is not the lowest note) as an inversion chord. When the root is in the bass, we call the chord: root-position chord. If we put the Third and Fifth in the root position, then it forms "Inversion", we call this chord "Inversion Chord". See the following major triad and its inverted chord.

Chord Name

The chord name contains two parts content: Chord root and Chord type.

Single Finger

Single-finger makes it simple to produce major, seventh, minor and minor seventh chords by pressing a minimum number of keys on the auto accompaniment section.

Multi-finger

Multi-finger allows you to play chords in normal fingering. Try playing the 32 chord types in C scale as listed on the right.

Note:

In full range mode, the entire keyboard will only recognize chords played in normal fingering.

C		★ Major Triad Only press the root note on the keyboard.
Cm		★ Minor Triad Press the root note and the nearest left black key simultaneously.
C7		★ Seventh chord Press the root note and the nearest left white key simultaneously.
Cm7		★ Minor seventh chord Press the root note and the nearest left white and black keys simultaneously.

0 C	1 C ₆	2 C _{M7}	3 C _{M7} (#11)	4 C _M (9)	5 C _{M7} (9)
6 C ₆ (9)	7 C _{aug}	8 C _m	9 C _{m6}	10 C _{m7}	11 C _{m7} (b5)
12 C _m (9)	13 C _{m7} (9)	14 C _{m7} (11)	15 C _m M ₇	16 C _m M ₇ (9)	17 C _{dim}
18 C _{dim7}	19 C ₇	20 C ₇ SUS ₄	21 C ₇ (#b5)	22 C ₇ (9)	23 C ₇ (#11)
24 C ₇ (13)	25 C ₇ (b9)	26 C ₇ (b13)	27 C ₇ (#9)	28 C _{M7} aug	29 C ₇ aug
30 C _{SUS4}	31 C ₁₊₂₊₅	Notes enclosed in parentheses@are optional; the chords could be recognized without them.			

Auto Accompaniment

Tempo

Each style of the instrument has been set with a default or standard tempo, however, this can be changed by using the [TEMPO +]/ [TEMPO -] button.

1. Use the [TEMPO +]/ [TEMPO -] button to change the tempo value. While the tempo data is flashing, also use the data dial.
2. Press the [TEMPO+] and [TEMPO-] buttons simultaneously to restore the tempo value to its default setting.

Note:

The default tempo is automatically selected when you select a style in the style standby mode. But the value still keeps the same if you change styles in the playback mode.

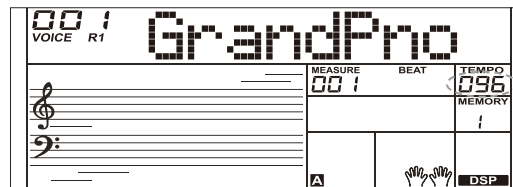

Fade In/Out

1. Fade In

Starting the style with fade in produces a smooth beginning, the volume increases from low to high.

Holding down the [SHIFT] button and press the [FADE] button before start the style playback. The "FADE" icon will light up, and then keep flashing with style playing.

2. Fade Out

Stopping the style with fade out produces a smooth ending, the volume decreases from high to low. Holding down the [SHIFT] button and then press the [FADE] button during the style playback. The "FADE" icon lights up, and then keeps flashing with style playing.

3. Fade In/ Out time

The default time is 10 seconds.

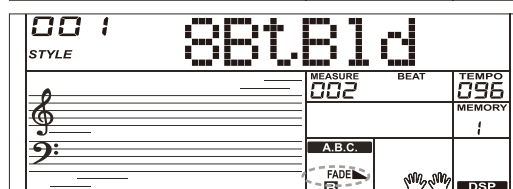
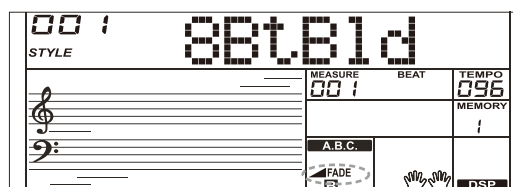

Metronome

The Metronome function provides a steady beat to help practicing the piano at a consistent tempo.

1. Turn the metronome on/ off

Press the [METRONOME] button to turn metronome function on or off.

2. Metronome beat type setting

Please refer to the "Function Menu" for details.

Notes:

1. If turn the metronome on while a style is playing, the click sound will be sounded at the next beat. The metronome time signature will synchronize to a style which is playing.
2. If turn the metronome on first, and then play rhythm, the metronome time signature will synchronize to a style which is playing.
3. The metronome function is available for recording mode, but it cannot be saved as a recording data.

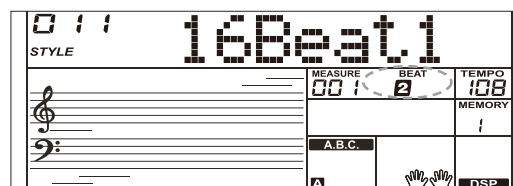
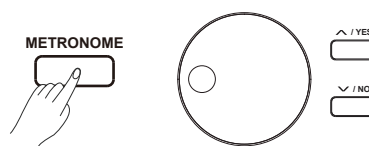

One Touch Setting

Maybe it is not easy to find out a suitable voice to play the song, nevertheless, ONE TOUCH SETTING is the most powerful and relaxed method to solve it. When One Touch Setting is switched on, you can instantly recall all auto accompaniment related settings including voices selection and digital effects simply with a single touch of a button.

Auto Accompaniment

1. Press the [O.T.S.] button to turn on the One Touch Setting for current style. The " O.T.S" icon will light up. The "MEMORY" icon will be off.
2. Press one of the [M1]-[M4] button, various panel settings (such as voice, effect, etc.) that match the selected style can be instantly recalled with just a single button.

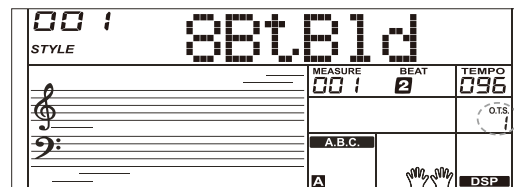
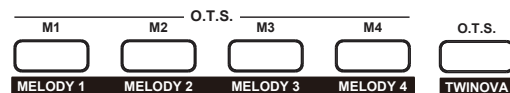

One Touch Setting parameter list:

- Part ON/OFF .
- Voice Change
- Voice Volume
- Voice Reverb Level
- Voice Chorus Level

Notes:

1. The A.B.C. function is automatically turned on in O.T.S. mode.
2. The "Registration Memory" function is invalid in the O.T.S. mode.

Mixer

Mixer function can control the volume of different tracks.

1. Holding down the [SHIFT] button and press the [MIXER -] / [MIXER +] button to enter the mixer function menu, the LCD displays the current number. The first rhythm volume value option is "Rhythm_s" for the first time , it will keep the last option when you enter the mixer menu again.
2. Holding down the [SHIFT] button, and press the [MIXER -] / [MIXER +] button repeatedly to select the track to be setting. Use [+ /YES] / [- /NO] button or data dial to change parameters.

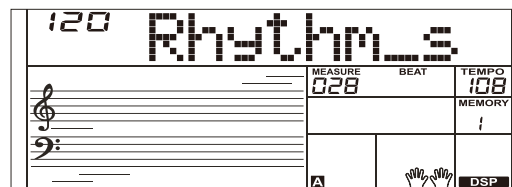
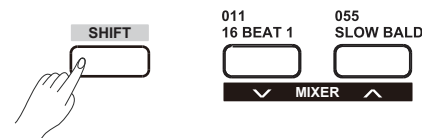

The option and parameters are shown below:

Content	LCD Display	Range
Rhythm s volume	XXX Rhythm_ s	0 - 127
Rhythm m volume	XXX Rhythm_ m	0 - 127
Bass volume	XXX Bass	0 - 127
Chord 1 volume	XXX Chord1	0 - 127
Chord 2 volume	XXX Chord2	0 - 127
Chord 3 volume	XXX Chord3	0 - 127
Phrase 1 volume	XXX Phrase1	0 - 127
Phrase 2 volume	XXX Phrase2	0 - 127
Voice R1 volume	XXX Upper 1	0 - 127
Voice R2 volume	XXX Upper 2	0 - 127
Voice L volume	XXX LOWER	0 - 127
U_Disk midi play volume	XXX U_Disk	0 - 127

Note:

Without any operation within 5 seconds, the function menu status will exit automatically.

Harmony

The harmony function will automatically add harmony notes to the notes played in the right-hand section, which gives you a rich and harmonic expression.

Harmony Switch

1. Holding down the [SHIFT] button and press the [HARMONY] button to enter harmony mode. The "HARMONY" icon lights up and LCD displays "Duet" which indicates the harmony effect is open, and the type is Duet.
2. Holding down the [SHIFT] button and press the [HARMONY] button again to exit harmony mode. The "HARMONY" icon goes out and LCD displays "Off" which indicates the harmony effect is off.
3. This instrument features 26 harmony types. Please refer to the "Function menu" for details.

Playing with harmony effect

Open the A.B.C. mode, first play a chord in the chord section, and then the main voice you play in right-hand section will be added with the harmony effect.

Notes:

1. The harmony types of 1+5, Octave 1~2, Echo 1~4, Tremolo 1~4 and Trill 1~4 are available whether the A.B.C. is open or not. Other harmony types are available only when the A.B.C. is open.
2. The harmony types cannot be recorded in user songs.

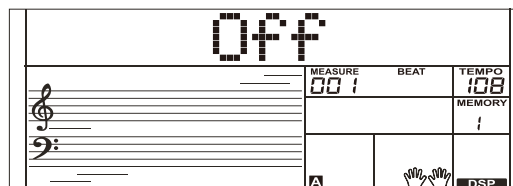
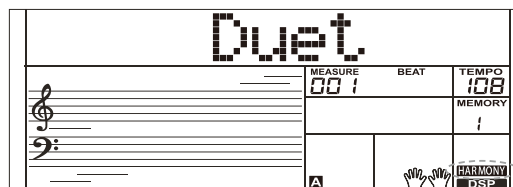
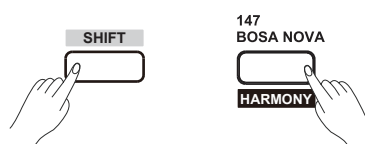

Performance Assistant

There are 2 voices you can select to perform in performance assistant mode: Guitar, Piano.

What's the Performance Assistant?

Performance assistant is an easy-to-use function. With this function, you will find playing to be more interesting. Even if you are not a keyboard player, the performance assistant will help you to play your familiar instrument voice on the keyboard. If you are a pianist, you can achieve many hard perform skills on the keyboard with the help of this function more easily. Performance assistant will provide many wonderful phrases. Just use several keys and you will perform your own wonderful music.

Enter the Performance Assistant

1. Press the [PERFORM.] button to enter the performance assistant mode. The default setting is Guitar Mode. The LCD will display the name and number of Guitar.
2. Use the data dial to change the voice you want to perform.
3. The default time signature "4-4" will be displayed on the LCD. In Performance Assistant mode, you can choose the beat between 2/4, 3/4, 4/4, and 6/8 with the [+ / YES] / [- / NO] button.

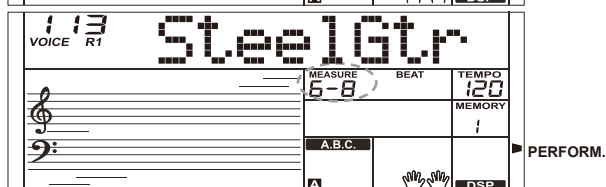
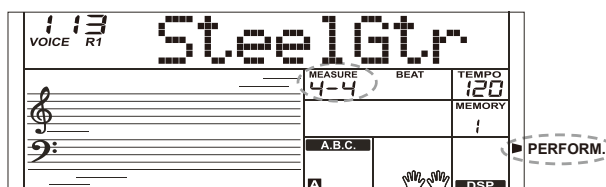
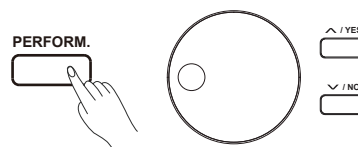

Performance Assistant

5. In Performance Assistant mode, use [TEMPO+] / [TEMPO-] to adjust the tempo value.

Guitar Mode

Guitar key map

The Guitar Mode makes you perform a guitar voice with keyboard just like you're playing a real guitar. In this mode you can use some perform skills like strum (5), broken chord (5), echoism (5) and also 2 endings.

Chord part

A0 to B3 is the chord part area. Play a chord in this area.

Sub Area 1

C4 to B4 (only white keys) is the sub area and 1. 5 types of broken chord are provided in this area.

Sub Area 2

The 6 keys: C5 to A5 (only white keys) is just like real guitar's 6 strings. Play a free solo in this area.

Rhythm Area

C6 to G6 (only white keys) is the rhythm area. Wonderful styles and strums are provided in this area. Use A6 to B6 to play an ending.

Position Change

Press C7, the guitar voice will be changed to a high position.

Note:

The keys above C7 cannot be responded in this mode.

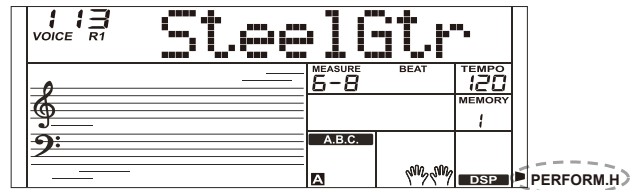

Guitar Key map

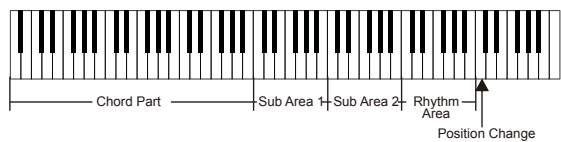

Playing in Guitar Mode

Play a chord in the chord part

A chord type will be displayed on the LCD and the guitar root note will be sounded.

Play a broken chord in the sub area 1

When the chord type displayed, press a white key in the sub area 1, a wonderful broken chord phrase will start. Try to change the white key and you will hear some different types of phrase. Change the chord with your left hand, you will hear the broken chord phrase has a little bit change.

Play a free solo in the sub area 2

When the chord type displayed, press a white key in the sub area 2 you can play guitar free solo, sounds of which like you're playing a real one. Try to change the chord with your left hand, and play your free solo. The last white key B5 is invalid.

Play a strum rhythm in the rhythm area

When the chord type displayed, press a white key in the rhythm area you can play the magic strum rhythm. Try to change the chord with your left hand, and play your strums.

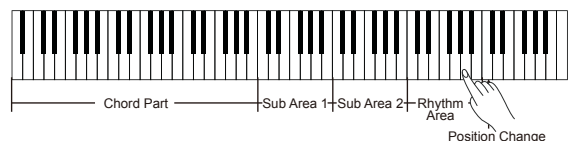
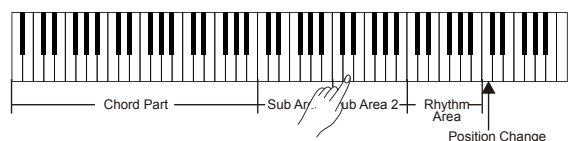
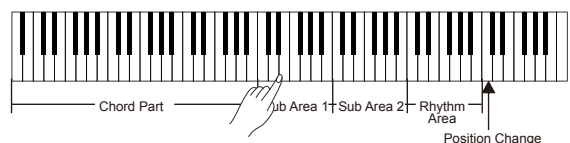
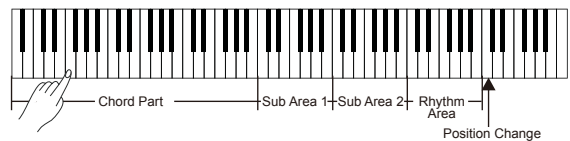

Performance Assistant

End the guitar performing

Press the A6 or B6 to end your guitar performs. When the ending is finished, the phrase stops automatically.

Play the echoism

All of black keys on Sub area 1, Sub area 2 and Rhythm area are echoism keys. There are 5 kinds of echoism to arrange on the C#, D#, F#, G#, A# circularly.

Change the position

Press the C7, the "PERFORM.H" icon will light up on the LCD. It means that the guitar position has been changed to the High position. Try to play the white keys in sub area 1, Sub area 2 and Rhythm area, listen to the phrase you are performing now.

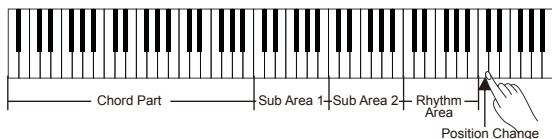
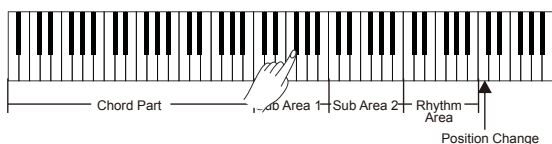

Piano Mode

Piano Key Map

In Piano Mode, you can easily achieve many hard piano perform skills just like playing the acoustic one. In this mode you can use some perform skills like piano rhythm (5), broken chord (5) and also 3 endings.

The piano key map is similar with the guitar key map. Press A6 to C7 (white keys) to start an ending. All the black keys above C4 are invalid.

Piano Key map

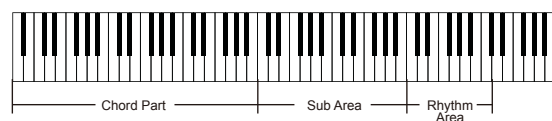

Playing in Piano Mode

1. Select Piano Mode
In performance assistant mode, use data dial to select Piano Mode.
2. Play a chord in chord part
3. Play phrases and rhythm in sub area and rhythm area.
4. Press the A6, B6 or C7 to end your piano perform. When the ending is finished, the phrase stops automatically.

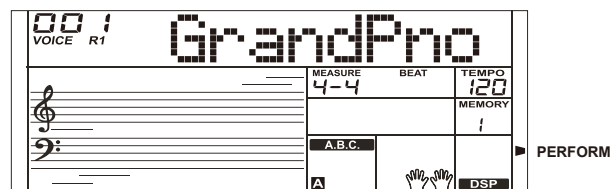

Exit the Performance Assistant

When the performance is complete, press the [VOICE] / [STYLE] / [SONG] / [PERFORM] to exit the performance assistant mode.



DSP

The DSP effect is the sound localization technology for simulating the sounds in the real environment. With the DSP effect, you can add ambience and depth to your performance in a variety of ways.

The DSP effect is automatically open when the instrument is turned on. Holding down [SHIFT] button and press the [DSP] button to turn the DSP effect on or off. The “DSP” icon lights up.

Note:

It may cause a break or a noise while switching on/off the DSP when the style or the song is playing. It is normal and need not to panic.

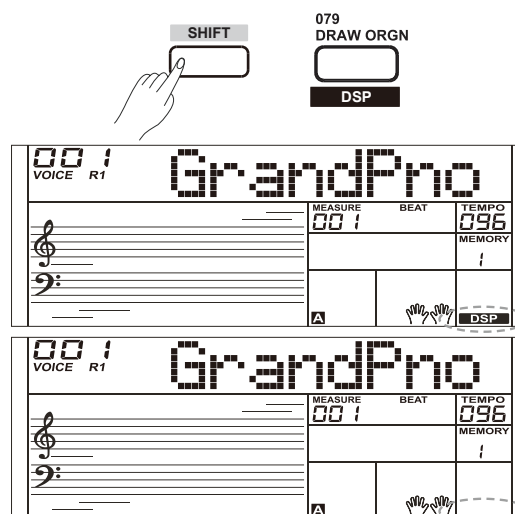

Pedal Function

You can assign other pedal functions to the sustain pedal. Please refer to the Function Menu for details.

1. Sustain Pedal (SPd Sust)

This pedal function performs the same function as the damper pedal on an acoustic piano, letting you sustain the sound of voices even after releasing the keys. Step and press on the pedal to turn the sustain effect on. Release the pedal to turn the sustain effect off.

2. Soft Pedal (SPd Soft)

When the soft pedal is selected, pressing this pedal and makes the notes you playing sound softer.

3. Style Start/Stop Pedal (SPd St/T)

When the style start/stop pedal is selected, pressing this pedal to start/stop the accompaniment.

4. Memory Pedal (SPd Mem)

When the memory pedal is selected, pressing this pedal at the first time to call up register memory: M1, and then you can call up register memory M2, M3...by pressing this pedal step by step (There are 48 memories).

The soft pedal of a unit pedal can be assigned with other pedal functions. Please refer to the Function Menu for details.

1. Pedal Soft (UPd Soft)
2. Pedal St/T (UPd St/T)
3. Pedal Mem (UPd Mem)

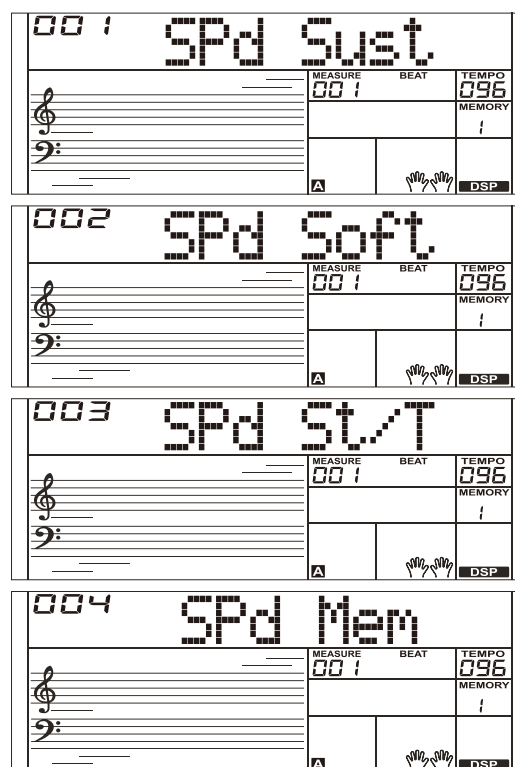

Function Menu

Holding down the [SHIFT] button and press the [FUNCTION-] or [FUNCTION+] button to enter function menu. The LCD displays the current function menu option. Use the [+ / YES] / [- / NO] button or data dial to set parameters of the current menu.

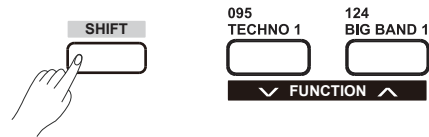

The option and parameters are shown below:

CONTENT	LCD DISPLAY	RANGE	DEFAULT
Tune	XXX Tune	-50...50	0
Beat Type	XXX Beat	0,2...9	4
Split Point	XXX Split Pt	1...88	34
Pedal Type	00X SPd ****	SUST, SOFT, St/T, MEM	SUST (001)
	00X UPd ****	SOFT St/T MEM	Soft (001)
Harmony Type	00X HAR TYPE	Duet, StandardTrio, Full Chord, Rock Duet, Country Duet, Country Trio, Block, 4 Close 1, 4 Close 2, 4 Open, 1+5, Octave1, Octave2, Strum, Echo1, Echo2, Echo3, Echo4, Tremolo1, Tremolo2, Tremolo3, Tremolo4, Trill1, Trill2, Trill3, Trill4	Duet (001)
EQ Type	XXX EQ TYPE	EQ Pop, EQ Rock, EQ Class, EQ Jazz, EQ Dance, EQ Reset	006 EQ Reset
Reverb Type	XXX Rev TYPE	RevRoom1/RevRoom2/RevRoom3/RevHall1/RevHall2/RevHall3/ Rev Chr1/Rev Chr2/Rev Del/Rev PanD	004 RevHall1
Reverb Level	XXX Rev Lev	0 – 127	Current voice
Chorus Type	XXX Chr TYPE	Chorus1/Chorus2/GM Chr1/GMChr2/Flanger1/Flanger2/Rotary1/Rotary2	004 GM chr2
Chorus Level	XXX Chr Lev	0 – 127	Current voice
MIDI Receive	XXX Receive	01—16, ALL	ALL
MIDI Transmit	XXX Transmit	01—16	01
Auto Power Off	XXX POWEROFF	Off,30,60	30

Note:

Without any operation within 5 seconds, system will exit the Function mode automatically.

Tune

This function sets the pitch of entire keyboard in semitone step.

1. Holding down the [SHIFT] button and press the [FUNCTION-]/[FUNCTION+] button repeatedly to select the tune menu. The LCD displays “xxx Tune”. Use the [+ / YES] / [- / NO] button to adjust the tune value.
2. Press the [+ / YES] and [- / NO] buttons simultaneously to restore the tune value to its default setting: 000. The setting is applied to both the accompaniment and the voice.

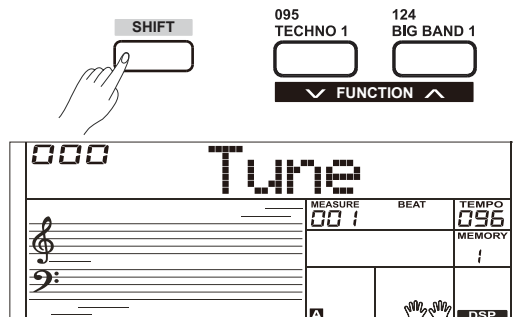

Split Point

The Point on the keyboard that separates voice L and voice R1/R2 is called the “split point”. Left hand section controls the auto bass chord accompaniment when the A.B.C. function is on, or it can be used to play the lower voices when the A.B.C. function is off.

1. Holding down the [SHIFT] button and press the [FUNCTION-]/[FUNCTION+] button repeatedly to select split point menu, the LCD displays “**** Split Pt”. Use the [+ / YES] / [- / NO] button to change the split point. Adjustable range is: 1~88.

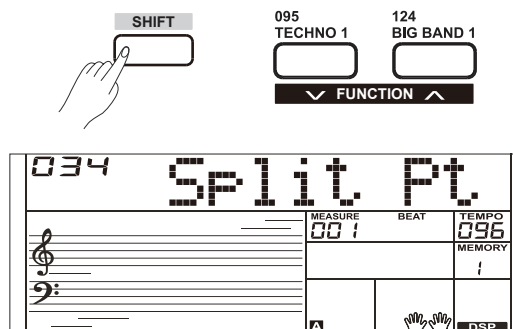

Function Menu

2. Press the [+ / YES] and [- / NO] buttons simultaneously restore the split point value to its default setting: F#3 (34).
3. In TWINOVA function, the adjustable range of split point is C3~C6 (28~64). Press the [+ / YES] and [- / NO] buttons simultaneously to restore the split point to its default setting: E3 (32).

Note:

The key of the split point belongs to the left hand.

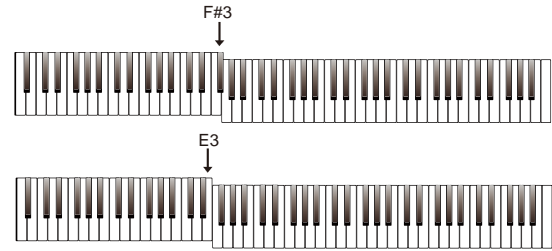

Beat Type

1. Holding down the [SHIFT] button and press the [FUNCTION-] or [FUNCTION+] button repeatedly to select beat type menu. The LCD displays "****Beat". Use the [+ / YES] / [- / NO] button or data dial to change beat type. The adjustable range is: 0, 2~9.
2. Press the [+ / YES] and [- / NO] buttons simultaneously to restore the beat type value to its default setting: 004.

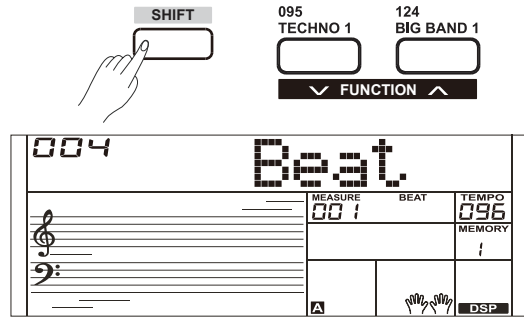

Pedal Type

1. Holding down the [SHIFT] button and press the [FUNCTION-] or [FUNCTION+] button repeatedly to select the sustain pedal type menu. The LCD displays "00x SPd xxxx". Use the [+ / YES] / [- / NO] button or data dial to change pedal type.
2. Press the [+ / YES] and [- / NO] buttons simultaneously restore the pedal type to its default setting: 001 SPd (Sust).
3. Follow the operation in Step 1 to assign functions to the soft pedal of a unit pedal, except that the LCD displays "00X UPd xxxx".

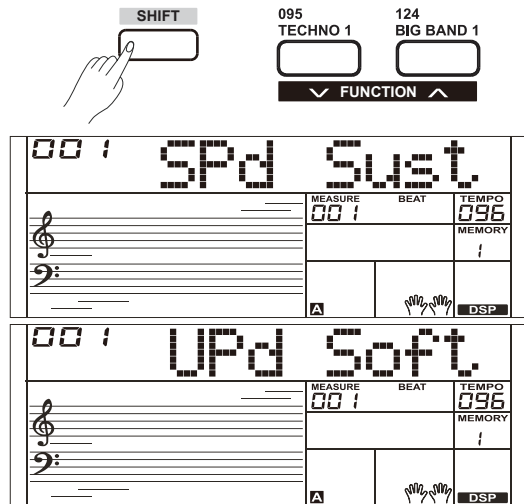

All pedal types are shown below:

No.	Sustain Pedal (Assignable Functions)	LCD	Soft Pedal (Assignable Functions)	LCD
1	Sustain Pedal	SPd Sust	Soft Pedal	UPd Soft
2	Soft Pedal	SPd Soft	Start/Stop Pedal	UPd St/T
3	Start/Stop Pedal	SPd St/T	Memory Switch Pedal	UPd Mem
4	Memory Switch Pedal	SPd Mem		

EQ Type

Equalizer is a sound processor that can be used to adjust the gain value of each frequency band of sound, different gain value settings can make a different sound field effect. You can select one of the 6 preset EQ settings in the EQ display.

1. Holding down the [SHIFT] button and press the [FUNCTION-] or [FUNCTION+] button repeatedly to select the EQ type menu. The LCD displays "001 EQ Pop". Use the [+ / YES] / [- / NO] button or data dial to change EQ type.
2. Press the [+ / YES] and [- / NO] buttons simultaneously to restore the EQ type to its default setting: 006 EQ Reset.

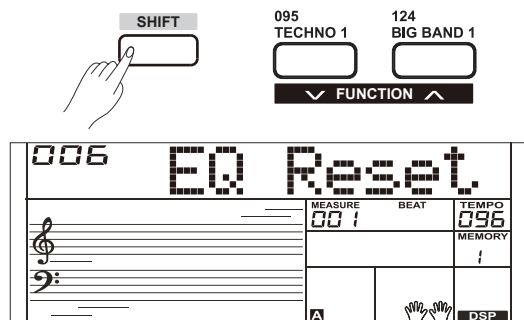

The EQ types are shown below:

No.	LCD	EQ Type
1	EQ Pop	Pop
2	EQ Rock	Rock
3	EQ Class	Classical
4	EQ Jazz	Jazz
5	EQ Dance	Dance
6	EQ Reset	Reset

Function Menu

Reverb Type

1. Holding down the [SHIFT] button and press the [FUNCTION-] or [FUNCTION+] button repeatedly to select the reverb type menu. The LCD displays "001 Rev Hall 1". Use the [+ / YES] / [- / NO] button or data dial to change reverb type.
2. Press the [+ / YES] and [- / NO] buttons simultaneously restore the reverb type to its default setting: 004 Rev Hall1.

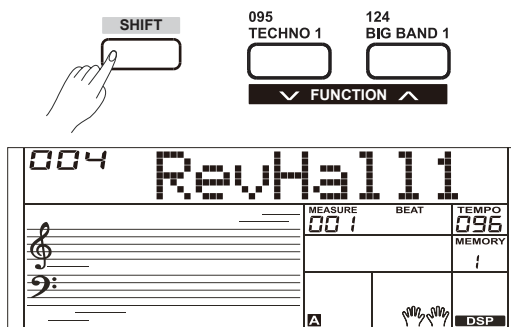

The reverb types are shown below:

No.	LCD	Reverb Type
1	RevRoom1	Room 1
2	RevRoom2	Room 2
3	RevRoom3	Room 3
4	RevHall1	Hall 1
5	RevHall2	Hall 2
6	RevHall3	Hall 3
7	Rev Chr1	Church 1
8	Rev Chr2	Church 2
9	Rev Del	Delay
10	Rev PanD	Pan Delay

Reverb Level

1. Holding down the [SHIFT] button and press the [FUNCTION-] or [FUNCTION+] button repeatedly to select reverb level. The LCD displays "070 Rev Lev". Use the [+ / YES] / [- / NO] button or data dial to change reverb level, adjustable range is: 0-127
2. Press the [+ / YES] / [- / NO] button simultaneously to restore the reverb level to its default setting: 070.

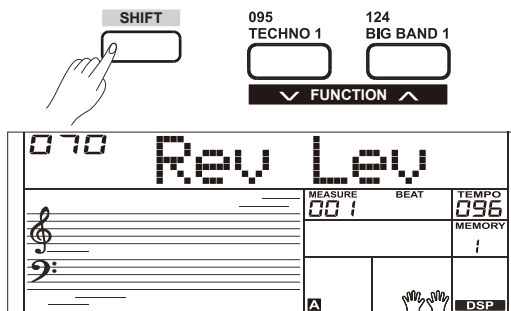

Chorus Type

1. Holding down the [SHIFT] button and press the [FUNCTION-] or [FUNCTION+] button repeatedly to select chorus type menu. The LCD displays "004 GM Chorus2". Use the [+ / YES] / [- / NO] button or data dial to change chorus type. You can select one of the 8 preset in the Chorus Type.
2. Press the [+ / YES] / [- / NO] buttons simultaneously to restore the chorus type to its default setting: 004 GM Chorus2.

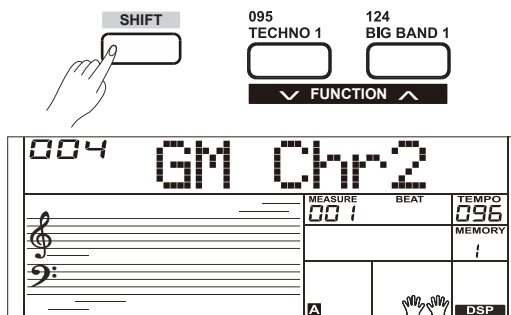

The chorus types are shown below:

No.	LCD	Chorus Type
1	Chorus1	Chorus 1
2	Chorus2	Chorus 2
3	GM Chr1	GM Chorus 1
4	GM Chr2	GM Chorus 2
5	Flanger1	Flanger 1
6	Flanger2	Flanger 2
7	Rotary1	Rotary 1
8	Rotary2	Rotary 2

Function Menu

Chorus Level

1. Holding down the [SHIFT] button and press the [FUNCTION-] or [FUNCTION+] button repeatedly to select chorus level menu. The LCD displays “*** Chr Lev”, Use the [+ /YES] / [- /NO] button or data dial to change chorus level, adjustable range is: 0-127.
2. Press the [+ /YES] and [- /NO] buttons simultaneously to restore the chorus level to its default setting: 000.

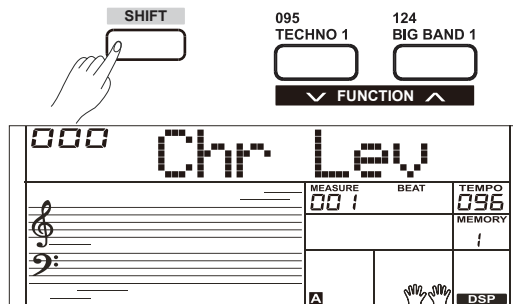

Harmony Type

1. Holding down the [SHIFT] button and press the [FUNCTION-] or [FUNCTION+] button repeatedly to select harmony type menu. The LCD displays “001 Duet”. Use the [+ /YES] / [- /NO] button or data dial to change harmony type.
2. Press the [+ /YES] and [- /NO] buttons simultaneously to restore the harmony type to its default setting: 001 Duet.

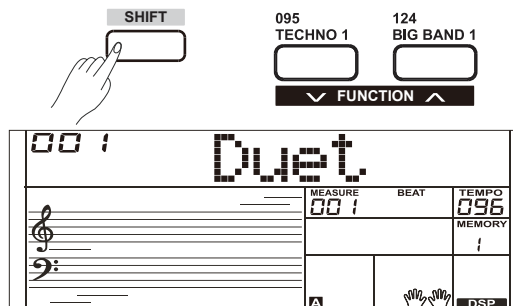

The harmony types are shown below:

No.	LCD	Harmony Type
1	Duet	Duet
2	STD Trio	Standard Trio
3	FulChord	Full Chord
4	RockDuet	Rock Duet
5	CtryDuet	Country Duet
6	CtryTrio	Country Trio
7	Block	Block
8	4Close1	4 Close 1
9	4Close2	4 Close 2
10	4 Open	4 Open
11	1+5	1+5
12	Octave1	Octave 1
13	Octave2	Octave 2
14	Strum	Arpeggio
15	Echo1	Echo1
16	Echo2	Echo2
17	Echo3	Echo3
18	Echo4	Echo4
19	Tremolo1	Tremolo1
20	Tremolo2	Tremolo2
21	Tremolo3	Tremolo3
22	Tremolo4	Tremolo4
23	Trill1	Trill1
24	Trill2	Trill2
25	Trill3	Trill3
26	Trill4	Trill4

Function Menu

MIDI IN

1. Holding down the [SHIFT] button and press the [FUNCTION-] or [FUNCTION+] button to select the MIDI In menu. The LCD displays “*** Midi In”. Use the[+/YES]/ [-/NO] button or data dial to adjust MIDI in channel: 1~16, ALL.
2. Press the[+/YES] and [-/NO] buttons simultaneously to restore the MIDI In channel to its default setting: ALL.

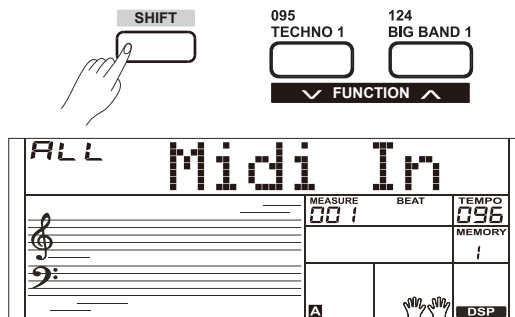

MIDI OUT

1. Holding down the [SHIFT] button and press the [FUNCTION-] or [FUNCTION+] button repeatedly to select MIDI Out menu. The LCD displays “*** MIDI Out”. Use the[+/YES]/ [-/NO] button or data dial to adjust MIDI Out channel: 1~16.
2. Press the [+/YES] and [-/NO] buttons simultaneously to restore the MIDI out channel to its default setting: 001.

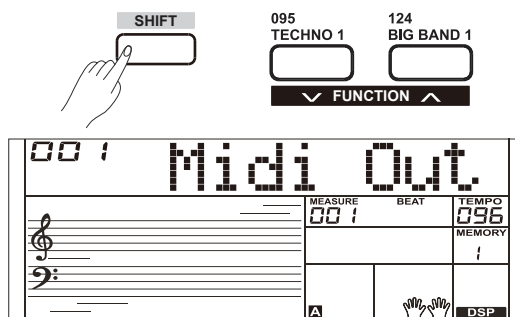

Auto Power Off

This function is used to set the auto power off time.

1. Holding down the [SHIFT] button and press the [FUNCTION-] or [FUNCTION+] button repeatedly to enter the auto power off menu. The LCD displays “*** Power Off”. Use the [+/YES]/ [-/NO] button or data dial to change auto power off time: 30 minutes, 60minutes or OFF.
2. Press the[+/YES] and [-/NO] buttons simultaneously to restore the auto power off time to its default setting: 030(30 minutes).

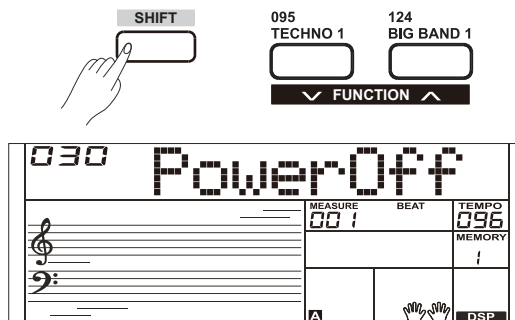

Registration Memory

This instrument has a Registration Memory feature that lets you save your favorite settings for easy recall whenever they are needed

Registering the Panel Setting

1. There are 8 memory banks, and each bank has 6 memories (M1-M6).
2. Holding down the [STORE] button and press one of the registration memory buttons: [M1] - [M6]. Notice that the new settings will replace the previous memory data.

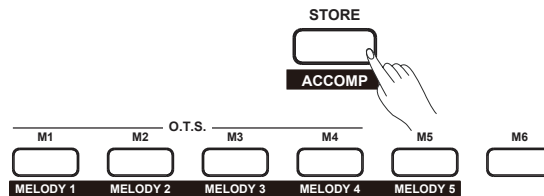

Note:

Press the [STORE] and [M1] button simultaneously then power on, the registration memory will be restored to its default setting.

Recalling the Registered Panel Settings

Press one of the registration memory buttons: [M1] - [M6]. If you choose bank 1, and then press [M1] button, the panel settings stored in the memory 1 of bank 1 are recalled. Meanwhile the LCD displays "1-1".

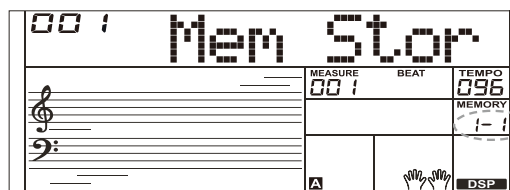
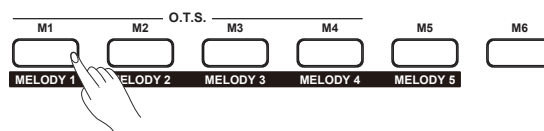

Note:

Registration data cannot be recalled when the One Touch Setting function is on.

Selecting a Registration Bank

1. Press the [BANK] button. The LCD will display the current bank number.
2. Press the [BANK] button repeatedly to select bank settings: 1~8.
3. You can save following parameters into [M1]-[M6].
 - Voice Parameter:** including main voice, dual, lower, DSP and mixer.
 - Accompaniment Parameter:** including style, tempo, chord mode on/off and section selection.
 - Function Parameter:** including touch, part parameters in function menu.

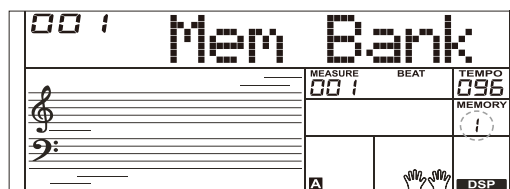

Record

With the easy-to-use song recording features, you can record your own keyboard performances as a user song. 5 user songs can be recorded, and you can record up to a total of 6 tracks: 5 MELODY tracks and 1 ACCOMP track, each track can be recorded individually.

Start Recording

Before you start recording, you need to select a user song to keep the recording song.

1. Holding down the [SHIFT] button and press the [RECORD] button to enter user song selection mode. The LCD displays "RecSong1" and the sequence number. Use the data dial, or the [+ / YES] / [- / NO] button to select the user song you want to record.

2. Holding down the [SHIFT] button and press the [RECORD] button again to enter record preparation mode. The "REC" icon will light up, four beats and the system automatically selected empty track "Melody1" or other track keeps flashing on the LCD.

3. In the recording preparation status, you can adjust parameters such as the voice, style and tempo. When recording a new song, the system will automatically select "Melody 1" as the recorded track. Holding down the [SHIFT] button and press "ACCOMP" (or "MELODY1" to "MELODY 5") to make your own selection. The ACCOMP track and one of MELODY track can be recorded at the same time, but it cannot record two MELODY tracks simultaneously.

4. Press the [START/STOP] button or play the keyboard to start recording. When choosing the ACCOMP track and A.B.C. is open, play an effective chord in left-hand section or press the [START/STOP] button to start recording.

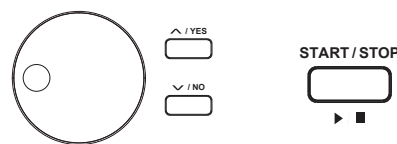
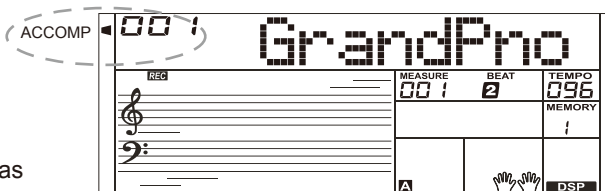
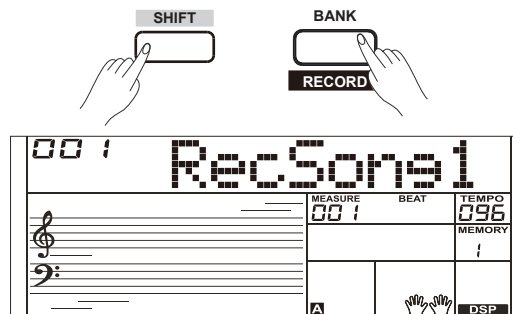

Select a Track

There are 3 states of the track cursor on the LCD: blinking, light and off.

Blinking: It means the track was chosen for recording. If the track has recorded data, the original data will be replaced.

Light: It means this track have recorded data, which will be played back during the recording process for other track.

Off: It means no data in this track, or this track have recorded data but cannot be played back. The 3 states can be switched by repeatedly press the relevant button to select "ACCOMP" track, "MELODY 1" track or "MELODY 2" track.

Notes:

- Record style with accompaniment track, and record melody with melody track.
- In the recording preparation status, you can repeatedly press the [ACCOMP], [MELODY 1] ~ [MELODY 5] button to shift track state. When recording an existing song, the keyboard will automatically select the empty track next to the occupied track. For example, if "Melody 1" is occupied, then "Melody 2" will be selected as the record track. When all 6 tracks have been recorded, select the "melody 1" track to save recordings.

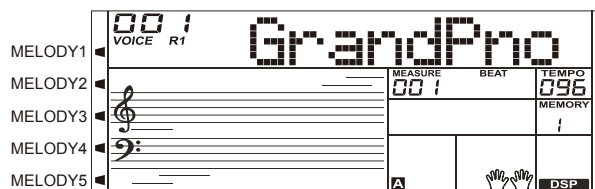
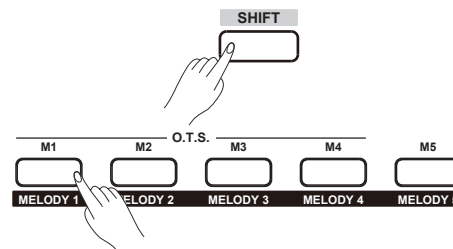

Record

Stop Recording

1. When recording is in process, holding down the [SHIFT] button and press the [RECORD] button to stop recording.
2. When recording is in process, if the memory is full, the recording will stop and save automatically, and the LCD displays "Rec_Full". If you choose the accompaniment recording, the recording will stop automatically when the ending of the rhythm finishes.

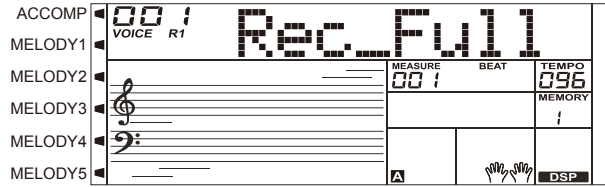

Playback Recording

1. When recording is in process, holding down the [SHIFT] button and press the [RECORD] button, it will stop recording and enter the song play mode, the LCD displays its default name "UserSong" and the number of user song, the current recorded song will play automatically in circle.
2. Press the [SONG] button to enter the song mode and it will play all songs circularly. Use the data dial, or the [+ / YES] / [- / NO] button to select a song, there are 125 songs in all, including 5 user songs (121~125). If there is no data in the selected user song, it will display "NoFile!" and stop playing in circle.

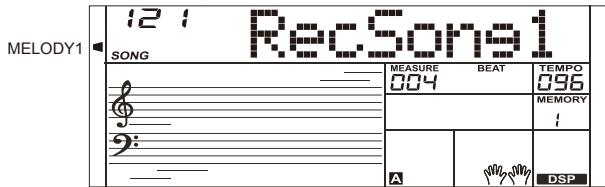
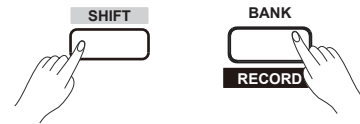

3. Press the [START/STOP] button to play a user song or select one user song in the song standby mode. Press the [START/STOP] button, this user song will be played in circle automatically.

Notes:

1. We have programmed power-off protection, all data of user songs will not be erased even the instrument is powered off.
2. To mute a track, simply press the button of selected track and the related cursor goes out, this track will have no sound when the song is played.

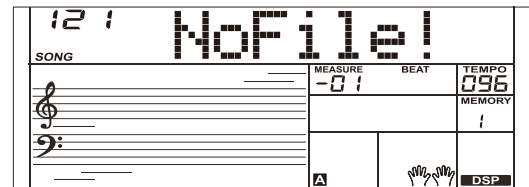

Delete User Song

1. While holding the [RECORD] and [SONG] buttons simultaneously turn power on, all user songs will be erased.
2. In the recording preparation status, holding down the [SHIFT] button and press the [RECORD] button for two seconds, the LCD will display "Delete?". Now hold down the [SHIFT] button and then press [ACCOMP] (or [MELODY 1] to [MELODY 5]) button to select the track you want to delete. In the delete user song mode, the lightened track icon means this track you want to delete. Otherwise, it means the track you want to keep. If all track icons light up, it means you will delete the whole user song after confirmation.
3. Choose the track you want to delete, press [+ / YES] to confirm and the recorded data in this track will be delete. Press [- / NO] to quit this step, and go back to the recording preparation status.

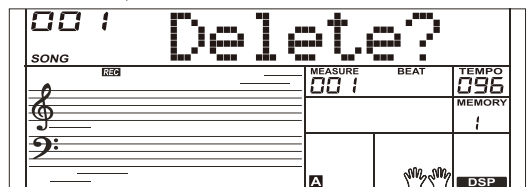
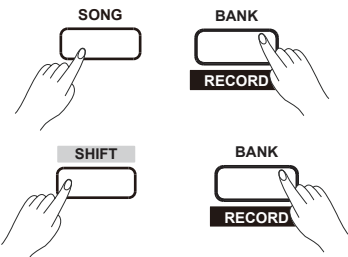

Song

The instrument has 120 songs in all, and each song has equipped with learning mode.

Listening to the Songs

1. Press the [SONG] button to enter the song mode. The LCD shows "SONG" icon and it will play all songs circularly.
2. Use the data dial or the [+ / YES] / [- / NO] button to select a song.
3. In song playing mode, press the [START / STOP] button to stop playing without exit the song mode. Press the [START / STOP] button again to play the current song in circle.
4. When the song is stopped, press the [STYLE] or [VOICE] button to exit the song mode.

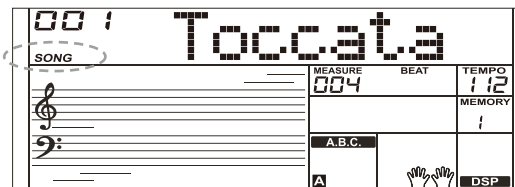
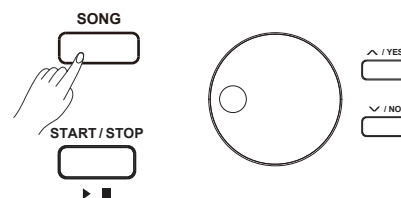

Song Control

1. **Introductory Beat**
Before the prelude of the song starts to playback, it has the introductory beat. The measure starts from the negative value. And the melody starts to play when the measure value comes to "1".
2. **REW, FF and PAUSE**
When the song is playing:
Press the [>>] button to fast forward the song.
Press the [<<] button to rewind the song (base on the measure).
Press the [||] button to pause the playing song, press again to continue playing.
3. **Song Repeat**
When playing the song, press the [] to set the loop begin and press it again to set the loop end. When in loop status, press [] again to quit the loop playing status.

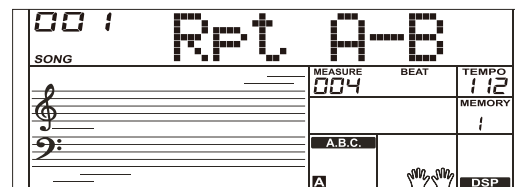
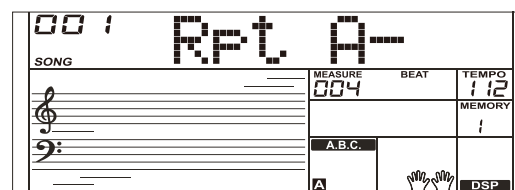

Lesson Mode

The lesson mode includes 3 buttons: [LESSON]/[LEFT]/[RIGHT]. The 3 buttons will work only in song mode and when song stops playing.

1. Holding down the [SHIFT] button and press the [LESSON] button to enter the LESSON mode. The default setting is right-hand lesson. Press the [LEFT] button to choose left-hand lesson. Press the [RIGHT] button to choose right-hand lesson. Press [LEFT] and [RIGHT] button simultaneously to choose the both-hands lesson. Press the [START/STOP] or [SONG] button to start lesson mode.
2. Switching lesson mode is not allowed in the process. After lessons, the system will mark automatically. No score will be on the LCD if stop learning in the process.

Notes:

1. Not every song can give practices for both hands.
2. For your convenience, the LCD displays the keys of rhythm or chord in the song mode.

Lesson 1

1. Holding down the [SHIFT] button and press the [LESSON] button to enter the lesson mode. The lesson 1 icon lights up on the LCD. In Lesson 1 mode, the system only grades the time value of the performance, but not the pitch or the chord.
 - If [RIGHT] is selected, it will mute melody of right hand and you will have to follow the time value of the right hand. As long as the time value is correct, the melody will sound.
 - If [LEFT] is selected, it will mute the changing chord and melody by left hand. You will have to follow time value of the left hand. As long as the time value is correct, the chord/melody will sound.
 - If [LEFT] and [RIGHT] are selected, the chord/melody of left hand and the melody of right hand will be muted.
2. Press the [START/STOP] / [SONG] button to start practice. Your performance will be evaluated by system.

Lesson 2

1. Holding down the [SHIFT] button and press the [LESSON] button twice to enter the lesson 2 mode. The lesson 2 icon lights up on the LCD. In LESSON 2 mode, the keyboard only grades your accuracy of pitch. The song stops until you play the correct note. The main melody will be hidden when you choose the right-hand lesson. The main melody and the chord will be hidden when you choose the left-land lesson.
2. Press the [START/STOP] / [SONG] button to start to practice. The system will give you a fair mark after lesson.

Note:

In this state, the note sounds only you play the right one.

Lesson 3

1. Holding down the [SHIFT] button and press the [LESSON] button thrice to enter "Lesson 3" Mode. The lesson 3 icon lights up on the LCD. The system grades the accuracy of both pitch and timing of notes when the song is playing. You must play the right notes in time with the correct value. The rhythmic accompaniment is still playing even if no notes are played.
2. The main melody will be hidden when you choose the right -hand lesson. The main melody and the chord will be hidden when you choose the left-land lesson. Press [LEFT] and [RIGHT] button simultaneously to choose both-hands lesson.
3. In LESSON 3 mode, hold down the [SHIFT] button, then press again the [LESSON] button to turn off the lesson mode, the icon on LCD will be off.

Note:

In this lesson mode, the notes are sounded whether they are right or wrong.

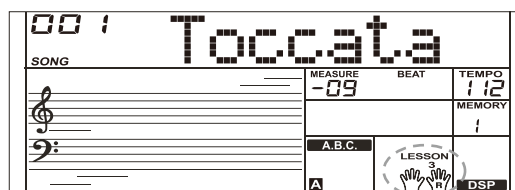
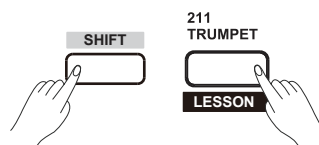
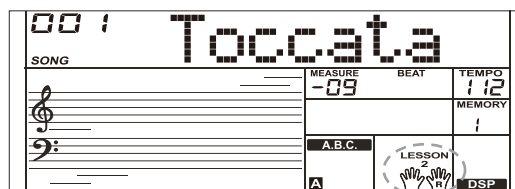
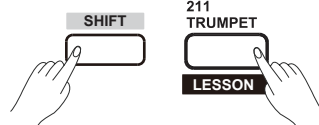
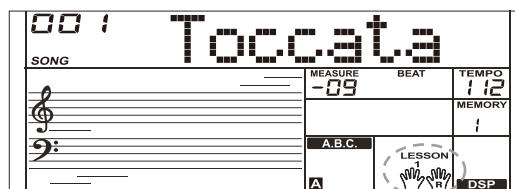
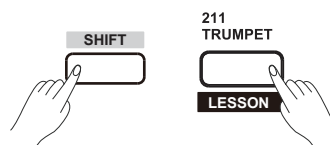
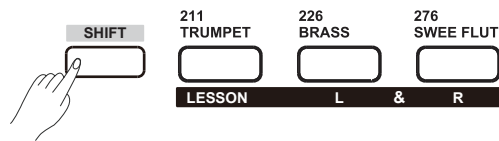

Chord Dictionary

If you know the name of a chord but don't know how to play it, you can use the Chord Dictionary function. You can learn the chord and test in this features.

DICT 1 (Chord Learning Mode)

Holding down the [SHIFT] button and press the [DICT.] button to enter the DICT 1 mode, the LCD displays "Dict.1" and the A.B.C. is automatically turned on.

In DICT 1 mode, the keys C4~B5 are used to assign the Chord Type, the keys C6~B6 are used to assign the Chord Root.

When the Chord Type and Chord Root are confirmed, the LCD will display the Chord and its keyboard position. For example, if you want to play a CM7 Chord, press the C6 key to specify C as the chord root. The root note you set will be shown on the LCD but the note does not sound. Refer to the picture on the right for assigning the Chord Root.

Press the E4 key to specify M7 as chord type. The notes you should play for the specified chord (root and chord type) are shown on the LCD as the notation and also the screen printing of the panel. When the Chord Type and Chord Root are confirmed, the LCD will display the chord and its keyboard position. A prompt sound will be heard when you play it correctly in the chord section of the keyboard.

DICT 2 (Chord Examining Mode)

Holding down the [SHIFT] button and press the [DICT.] button to enter the DICT 2 mode. This is an Examining mode. The chord area on the LCD will display a random chord while the keyboard position does not display anything on LCD.

When you play the correct chord within 3 seconds, the next chord (random) will be displayed on LCD to wait for the correct chord playing. If not, LCD will display the corresponding keyboard position automatically.

In DICT 2 mode, holding down the [SHIFT] button, and then press the [DICT.] button again to turn off chord dictionary.

24 Chords are indicated in the display as shown below:

Note	Chord Root	Note	Chord Type	Note	Chord Type
C6	C	C4	M	C5	7(b9)
C#6	C#/Db	C#4	M(9)	C#5	7(9)
D6	D	D4	6	D5	7(#9)
Eb6	Eb/D#	Eb4	mM7	Eb5	7(b13)
E6	E	E4	M7	E5	7(13)
F6	F	F4	M	F5	7(#11)
F#6	F#/Gb	F#4	M(9)	F#5	dim7
G6	G	G4	M6	G5	dim
Ab6	Ab/G#	Ab4	M7(9)	Ab5	7aug
A6	A	A4	M7	A5	aug
Bb6	Bb/A#	Bb4	M7b5	Bb5	7sus4
B6	B	B4	7	B5	sus4

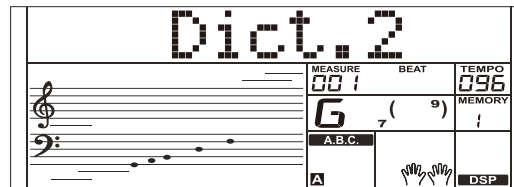
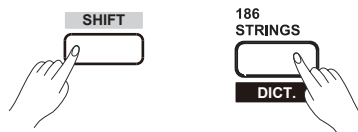
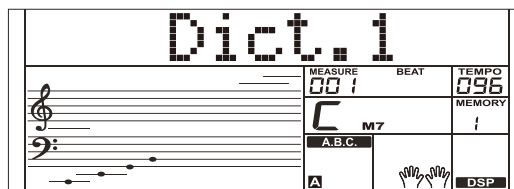
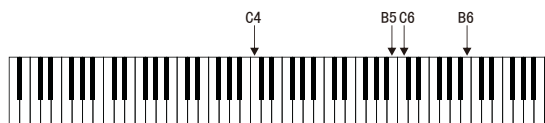
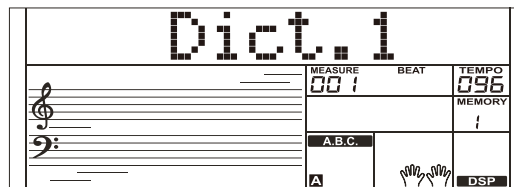
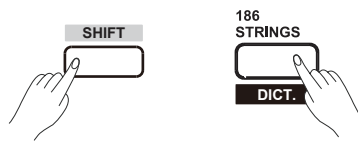

Connecting a USB Device

There is a standard USB Storage Device external interface which supports the USB Storage Device of 16M ~ 32G capability. It is compatible with the file system format of the FAT 16/32. It is better to use the USB Storage Device which is formatted by the keyboard. Please do not edit these files which come from the keyboard in PC.

USB Device Operation

1. In the mode, use the key as following: [USB DEVICE], [START/STOP] [+ /YES], [- /NO], data dial and [START/STOP].
2. Press [USB DEVICE] button to enter mode, press again to exit mode.
3. If the USB Storage device has been inserted before press the [USB DEVICE] button, the LCD will display "Wait...!". After the initialization finished, the LCD displays "Play".
4. If the initialization failed, the LCD will display "DiskErr!". If the USB Device has not been inserted, the LCD will displays "NoDisk!".
5. In the mode, use data dial to choose menu, or use the [+ /YES] button to the next operation, press [- /NO] to return to the previous menu.
6. In USB Storage mode, a directory includes 512 files at most. The LCD displays "DIR" for directory, "FILE" for files. Press the [USB Device]/[STYLE]/[SONG] button to exit USB Device mode.
7. When playing the MIDI files, press the [MIXER] button to adjust the volume.
8. You can only execute the operations of "Load", "Save", "Format" with the files in the directory "MMKD".

Note:

The "MMKD" folder will be generated automatically when user data is saved to the USB storage device.

Play

1. Press [USB DEVICE] button to enter mode, use data dial to choose "Play".
2. Press the [+ /YES] button, the LCD will display the name of MIDI and sub-directory.
3. When you choose a sub-directory, the LCD will display its name and the icon will light up. Press the [+ /YES] button to enter in.
4. Use data dial to choose a MIDI file. Press [START/STOP] to play the MIDI file in circle. Press [+ /YES] to start all files playback in circle. Press [START/STOP] again to stop.
5. Press the [+ /YES] button to return to previous menu when the LCD displays "...".

Load

1. Press the [USB DEVICE] button to enter USB Storage mode. Use data dial to choose "Load".
2. Press [+ /YES] to the enter subdirectory menu.

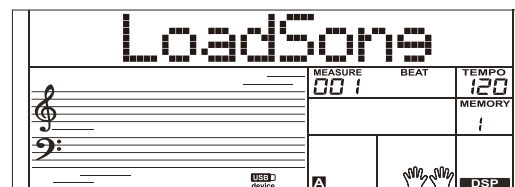
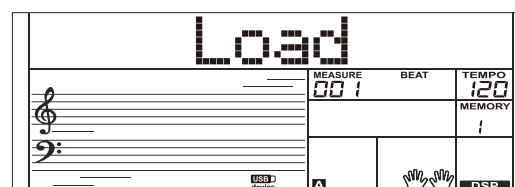
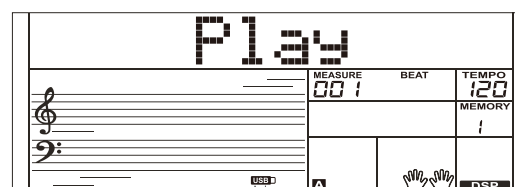
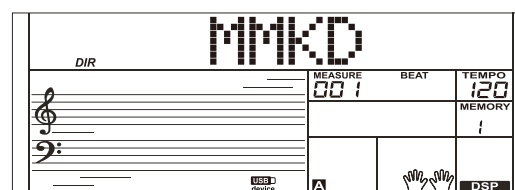
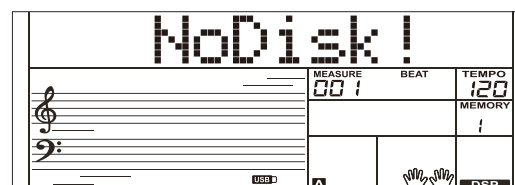
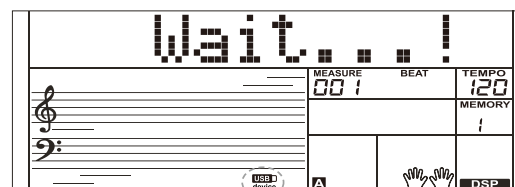
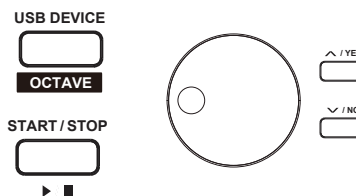

Connecting a USB Device

Load song

1. Select the menu "LoadSong" and press the [+ / YES] button, the MIDI files in the "SONG" directory of USB Storage Device are displayed on the LCD, use data dial to choose the file to be loaded.
2. Press the [+ / YES] button to confirm the file needed, the user song number will be displayed on LCD, select them by using data dial.
3. Press the [+ / YES] button, "Sure?" will be displayed on LCD, press the [+ / YES] button to load the file or press the [- / NO] button to cancel.

Load Style:

1. Select the menu "LoadSty" and press the [+ / YES] button, the style files in the "STYLE" directory of USB Storage Device are displayed on the LCD, select styles by using data dial.
2. Press the [+ / YES] button to confirm the file needed, the user style number will be displayed on LCD, select them by using data dial.
3. Press the [+ / YES] button, "Sure?" will be displayed on LCD, press the [+ / YES] button to load the file or press the [- / NO] button to cancel.

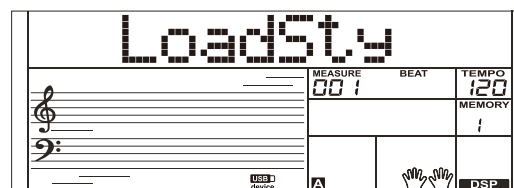

Load Memory:

1. Select the menu "LoadMem" and press the [+ / YES] button, the mem files in the "MEMORY" directory of USB Storage Device are displayed on the LCD. You can select memories by data dial.
2. Press the [+ / YES] button, "Sure?" will be displayed on LCD, press the [+ / YES] button to load the file or press the [- / NO] button to cancel.

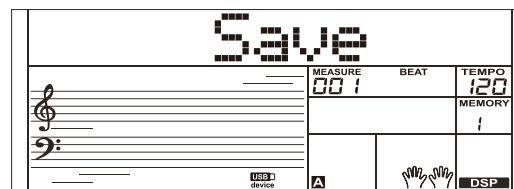

Save

1. Press the [USB DEVICE] button to enter USB Storage mode, use data dial to choose "SAVE".
2. Press the [+ / YES] button to enter subdirectory of saving. Use data dial to choose "SaveSong", "SaveSty", "SaveMem" and "SaveVoic".

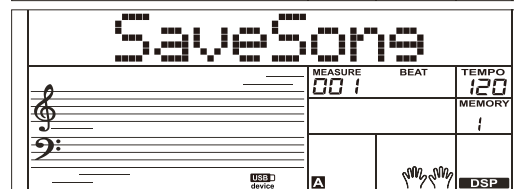

For example:

- Enter in the "Save Song" mode, press the [+ / YES] button, the LCD will display the current name and the number of user song. Use data dial to choose songs to be saved.
- Select the song to be saved, press the [+ / YES] button, the LCD displays "SNG_", use the keyboard to edit the name. After that. Press the [+ / YES] button, the LCD will display "Sure?" Press the [+ / YES] button to save, press the [- / NO] button to cancel.
- If the name is same as an exiting song, the LCD will display "SameName", and then you should edit another name to be saved. Operations in Style, Voice and Memory setting will be same as the name of user song.

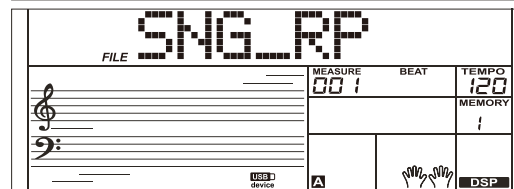

Delete

1. Press the [USB] button to enter USB Storage mode, use data dial to choose "Delete". Press [+ / YES] to enter delete menu, which includes "UserSong", "UserSty", "UserMem" and "UserVoic". Use data dial to select one.
2. Select the data to be deleted, press the [+ / YES] button to enter current menu. Select the one to be deleted, press the [+ / YES] button, the LCD displays "Sure?". Press [+ / YES] to delete, press [- / NO] to cancel.

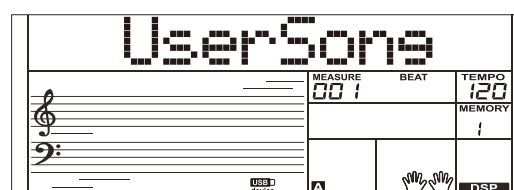
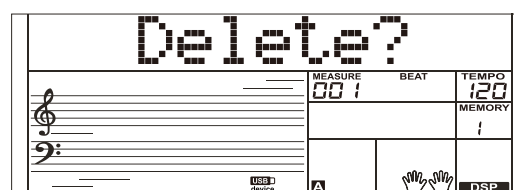

Connecting a USB Device

Format

Press the [USB] button to enter USB Storage mode, use data dial to Choose "Format". Press [+ / YES] to format the USB Storage Device, the LCD displays "Sure?". Press [+ / YES] to format the USB Storage, press [- / NO] to cancel.

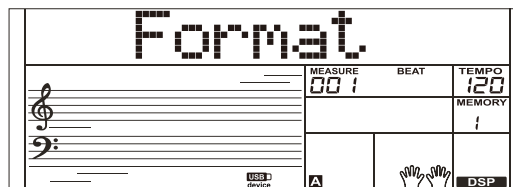

Note:

Formatting will delete all user data in the USB Storage Device!

Keyboard and ASCII Character Relative Table:

NOTE	C#2	D2	Eb2	E2	F2	F#2	G2	Ab2	A2	Bb2	B2
LETTER	DEL	BACK	NEXT	A	B	C	D	E	F	G	H

NOTE	C3	C#3	D3	Eb3	E3	F3	F#3	G3	Ab3	A3	Bb3
LETTER	I	J	K	L	M	N	O	P	Q	R	S

NOTE	B3	C4	C#4	D4	Eb4	E4	F4	F#4	G4	Ab4	A4
LETTER	T	U	V	W	X	Y	Z	0	1	2	3

NOTE	Bb4	B4	C5	C#5	D5	Eb5
LETTER	4	5	6	7	8	9

MIDI Functions

By using the MIDI functions you can expand your musical possibilities. This section explains what MIDI is, and what it can do, as well as how you can use MIDI on your instrument.

What's MIDI?

1. MIDI (short for Musical Instrument Digital Interface) allows a wide variety of electronic musical instruments, computers and other related devices to connect and communicate with one another. MIDI carries event messages that specify notation, pitch and velocity, control signals for parameters such as volume, vibrato, audio panning, and program change information to change the voice selections.
2. The instrument can output the real-time playback information via MIDI messages and control external MIDI devices. The instrument can also accept incoming MIDI messages and generate sound accordingly.

Note:

The USB connector belongs to USB device which can only be connected with PC. It is not allowed to be connected with the USB port of other instrument unless the one belongs to HOST.

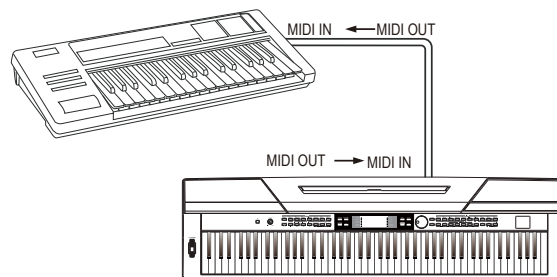

Downloading Data from the PC

1. Connect a standard USB cable between the USB jack of the instrument and the USB terminal of your PC.
2. Power on the instrument first, and then open the PCSUITE software in your PC, the "PCLink.." will be displayed on LCD, which indicates the PCSUITE has been connected successfully with the instrument.
3. You can download MIDI files to the instrument as user songs or upload the user songs. You can upload user styles to the PC as a backup or download them to the instrument.

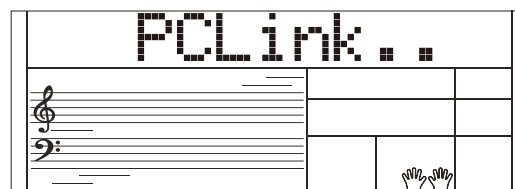
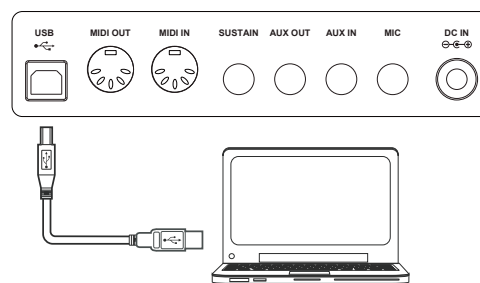

Restore Factory Setting

By pressing some designated combinations of buttons and keeping for a while, and then starting the instrument. This instrument will execute some special functions.

Restore Factory Setting

Holding down [+ / YES] and [- / NO] buttons simultaneously and then turn the [POWER] switch on, the instrument will be restored to its default setting. It will delete all the user data: user styles, user songs and registered memory. The LCD will display "Loading!". After the restore process is completed, the instrument will start normally. Handle with care!

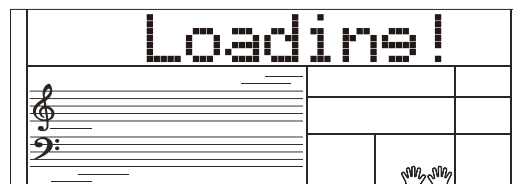
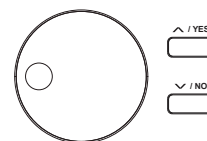

Restore the Registered Panel Settings

Holding down [STORE] and [M1] buttons simultaneously and then turn the [POWER] switch on, the instrument will be restored to its default setting. It will delete all data of registered memory. Handle with care!



Delete User Songs

Holding down [SONG] and [RECORD] buttons simultaneously and then turn the [POWER] switch on, the system will delete all user songs. Handle with care!

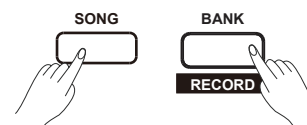

Troubleshooting

Problem	Possible Cause and Solution
The speakers produce a pop sound when the power is turned ON or OFF.	This is normal, please no cause for alarm.
No sound when the keyboard is played.	1. Make sure that the volume is set to an appropriate level. 2. Check the headphones if they are connected to the PHONES jack 2. 3. Make sure the R1/R2/L voice volume (in the Mixer) is set to an appropriate level.
When using a mobile phone, noise is produced.	Using a mobile phone close to the instrument may produce interference. To avoid this, turn off the mobile phone or use it further away from the instrument.
The auto accompaniment does not play back even Sync is in standby status and a key is pressed.	Please try to start accompaniment by playing a key in the right-hand section of the keyboard. To start the accompaniment with Sync Start, make sure to play a key in the left-hand section of the keyboard.
Certain notes sound at wrong pitch.	Make sure that the tuning value is set to 0. Holding down the [+ / YES] and [- / NO] buttons simultaneously, then turning the power on will set the instrument to its default setting.
The Harmony function does not operate.	Harmony cannot be turned on when a drum kit is selected for the voice R1.
The instrument cannot be recognized after connecting with PC via USB cable.	Please check if the USB cable is being connected firmly, or try to connect another USB port of the PC, without the need to install another driver on the PC.

Notice:

If you notice any abnormality cannot be handled, please connect the provider or specified repair station, and have the instrument inspected by qualified service personnel.

Specifications

Keyboard & Display	
Keyboard	88 Hammer-Action Keys
Touch Response	3 Types, Off
Display	Multi-functional LCD
Voices	
Polyphony (max.)	128
Voices	600
Layer	Left, Right1, Right2
Split	Yes
Duo (Twinova)	Yes
Styles	
Styles	230 preset, 10 user
Style Control	Start / Stop Sync Start Intro / Ending Main A / Fill in A Main B / Fill in B A.B.C. Fade In / Out Accomp volume
Style Creator	Yes (PC software)
O.T.S.	Yes
Chord Types	32
Effects	
Effects	DSP on / off
Master EQ	6 types
Reverb	10 types, 128 levels
Chorus	8 types, 128 levels
Performance Enhance	
Harmony	26 types
Performance Assistant	Yes
Song & Recording	
Music Library	120 preset songs, Music tutorial system
Sequencer	5 user songs (5 melody + 1 accomp.)
Demo Song	5
Pitch Adjustment	
Transpose	-12 ~ +12
Octave	-1 ~ +1 (Twinova)
Tuning	-50 ~ +50
Other Functions	
Mixer	Yes (12 tracks)
Performance Memory	8 preset banks x 6
Assignable Controllers	Sustain pedal
Pitch Bend	Yes
Metronome	0, 2 ~ 9
Tempo	30 ~ 280
Other control	Chord dictionary
Connections	
Interaction & Expansion	USB MIDI, PC software
External Drive	USB flash drive (32G max.)
Microphone	Yes
Phones	2 standard stereo
Pedals	Unit pedal, Sustain pedal
MIDI	In, Out
USB	USB MIDI
Input	Standard stereo
Output	Standard stereo
Power Supply	
Power	DC12V / 2A
Power Off Protection	Yes
Amplifiers & Speakers	
Amplifiers	10W x 2
Speakers	10W x 2 20W x 2
Dimensions & Weight	
Dimensions LWH (mm)	1365 x 366 x 137
Weight (kg)	13.8

* All specifications and appearances are subject to change without notice.

VoiceList

NO.	English Name	LCD Name
Piano		
1	Acoustic Grand Piano	GrandPno
2	Acoustic Grand Piano 2	GrandPn2
3	Acoustic Grand Piano 3	GrandPn3
4	Acoustic Grand Piano (wide)	GrandPnW
5	Acoustic Grand Piano (dark)	GrandPnD
6	Bright Acoustic Piano	BritePno
7	Bright Acoustic Piano 2	BritePn2
8	Bright Acoustic Piano 3	BritePn3
9	Bright Acoustic Piano (wide)	BritePnW
10	Electric Grand Piano	E.Grand
11	Electric Grand Piano 2	E.Grand2
12	Electric Grand Piano (wide)	E.GrandW
13	Electric Grand Piano (dark)	E.GrandD
14	Honky Tonk Piano	HnkyTonk
15	Honky Tonk Piano 2	HnyTonk2
16	Honky Tonk Piano (wide)	HnyTonkW
17	Honky Tonk Piano (dark)	HnyTonkD
18	Harpsichord	Harpsi
19	Harpsichord 2	Harpsi2
20	Harpsichord (octave mix)	HarpsiO
21	Harpsichord (wide)	HarpsiW
22	Harpsichord (with key off)	HarpsiOf
23	Octave Grand Piano	OctPno
24	Octave Grand Piano 2	OctPno2
25	Piano & Strings	Pno&Str
26	Piano & Pad	Pno&Pad
27	Piano & Choir	Pno&Cho
28	Piano & EP	Pno&EP
29	Piano & Vibraphone	Pno&Vib
30	Detuned Electric Piano	DetunEP
31	Detuned Electric Piano 2	DetunEP2
32	Electric Piano	E.Piano
33	Electric Piano 2	E.Piano2
34	Electric Piano 3	E.Piano3
35	Electric Piano 4	E.Piano4
36	Electric Piano 1 (velocity mix)	E.PnoV1
37	Electric Piano 2 (velocity mix)	E.PnoV2
38	60's Electric Piano	60'sEP
39	EP Legend	EPLegend
40	Phase EP	PhaseEP
41	Clavi	Clavi
42	Clavi 2	Clavi2
43	Phase Clavi	PhaseClv
44	Wah Clavi	WahClv
45	Pulse Clavi	PluseClv
46	Dream EP	DreamEP
47	Tremolo EP	TremoEP
48	Funk EP	FunkEP
49	Warm EP	WarmEP
50	Choir EP	ChoriEP
51	Wah EP	WahEP
52	Modern EP	ModernEP
53	EP Pad	EPPad

Chromatic Percussion		
54	Celesta	Celesta
55	Celesta 2	Celesta2
56	Celesta 3	Celesta3
57	Glockenspie	Glocken
58	Glockenspiel 2	Glocken2
59	Music Box	MusicBox
60	Music Box 2	MuscBox2
61	Music Box 3	MuscBox3
62	Vibraphone	Vibra
63	Vibraphone 2	Vibra2
64	Vibraphone (wide)	VibraW
65	Marimba	Marimba
66	Marimba 2	Marimba2
67	Marimba (wide)	MarimbaW
68	Xylophone	Xylophon
69	Xylophone 2	Xylopho2
70	Xylophone 3	Xylopho3
71	Tubular Bells	TubulBel
72	Tubular Bells 2	TubulBe2
73	Church Bell	ChurBell
74	Carillon	Carillon
75	Dulcimer	Dulcimer
76	Dulcimer 2	Dulcime2
77	Santur	Santur
Organ		
78	Italian 60's Organ	60'sOrgn
79	Drawbar Organ	DrawOrgn
80	Drawbar Organ 2	DrawOrg2
81	Detuned Drawbar Organ	DeDraOrg
82	Drawbar Organ 3	DrawOrg3
83	Detuned Percussive Organ	DePerOrg
84	Percussive Organ	PercOrgn
85	Percussive Organ 2	PercOrg2
86	70's Percussive Organ	70'sPcOr
87	Percussive Organ 3	PercOrg3
88	Rock Organ	RockOrgn
89	Rock Organ 2	RockOrg2
90	Rock Organ 3	RockOrg3
91	Church Organ	ChurOrgn
92	Church Organ 2	ChurOrg2
93	Church Organ 3	ChurOrg3
94	Church Organ (octave mix)	ChurOrgO
95	Detuned Church Organ	DeChuOrg
96	Reed Organ	ReedOrgn
97	Reed Organ 2	ReedOrg2
98	Rotary Organ	RotyOrgn
99	Puff Organ	PuffOrgn
100	Accordion	Acordion
101	Accordion 2	Acordin2
102	Accordion 3	Acordin3
103	Harmonica	Harmnica
104	Harmonica 2	Harmnic2
105	Harmonica 3	Harmnic3

VoiceList

106	Tango Accordion	TangoAcid
107	Tango Accordion 2	TangoAcid2
Guitar		
108	Acoustic Guitar (nylon)	NylonGtr
109	Acoustic Guitar (nylon) 2	NylonGt2
110	Acoustic Guitar (nylon) 3	NylonGt3
111	Acoustic Guitar (nylon + key off)	NylGtrOf
112	Ukulele	Ukulele
113	Acoustic Guitar (steel)	SteelGtr
114	Acoustic Guitar (steel) 2	SteelGt2
115	12-Strings Guitar	12StrGtr
116	Mandolin	Mandolin
117	Mandolin 2	Mandoli2
118	Steel Guitar with Body Sound	SteelBdy
119	Electric Guitar (jazz)	JazzGtr
120	Electric Guitar (jazz) 2	JazzGtr2
121	Electric Guitar (pedal steel)	PedalGtr
122	Electric Guitar (clean)	CleanGtr
123	Electric Guitar (clean) 2	CleanGt2
124	Electric Guitar (detuned clean)	DetClnGt
125	Mid Tone Guitar	MidTonGt
126	Electric Guitar (muted)	MutedGtr
127	Electric Guitar (muted) 2	MutedGt2
128	Electric Guitar (funky cutting)	FunkGt
129	Electric Guitar (muted velo-sw)	MutVelGt
130	Jazz Man	JazzMan
131	Overdriven Guitar	Ovrdrive
132	Overdriven Guitar 2	Ovrdriv2
133	Guitar Pinch	GtPinch
134	Distortion Guitar	DistGtr
135	Distortion Guitar 2	DistGtr2
136	Distortion Guitar (with feedback)	FeedbkGt
137	Guitar Feedback	GtrFedbk
138	Distorted Rhythm Guitar	DistRyth
139	Guitar Harmonics	GtrHarmo
140	Guitar Harmonics 2	GtHarmo2
141	Velocity Nylon Guitar	NylNtVe
Bass		
142	Acoustic Bass	AcoBass
143	Acoustic Bass 2	AcoBass2
144	Wah Bass	WahBass
145	Electric Bass (finger)	FngrBass
146	Finger Slap Bass	FngrSlap
147	Electric Bass (pick)	PickBass
148	Electric Bass (pick) 2	PickBas2
149	Fretless Bass	Fretless
150	Fretless Bass 2	Fretles2
151	Slap Bass	SlapBass
152	Slap Bass 2	SlapBas2
153	Slap Bass 3	SlapBas3
154	Slap Bass 4	SlapBas4
155	Synth Bass	SynBass
156	Synth Bass 2	SynBass2
157	Synth Bass 3	SynBass3

158	Synth Bass 4	SynBass4
159	Warm Synth Bass	WarmBass
160	Rsonance SynBass	ResoBass
161	Clavi Bass	ClavBass
162	Hammer	Hammer
163	Attack Bass	AtackBas
164	Synth Bass (rubber)	RubbBass
165	Synth Bass (rubber) 2	RubbBas2
166	Attack Pulse	AtackPls
Strings & Orchestral		
167	Violin	Violin
168	Violin 2	Violin2
169	Violin (slow attack)	SIViolin
170	Viola	Viola
171	Viola 2	Viola2
172	Cello	Cello
173	Cello 2	Cello2
174	Contrabass	Contrabs
175	Contrabass 2	Contrbs2
176	Tremolo Strings	TremStr
177	Tremolo Strings 2	TremStr2
178	Tremolo Strings 3	TremStr3
179	Pizzicato Strings	PizzStr
180	Pizzicato Strings 2	PizzStr2
181	Orchestral Harp	Harp
182	Orchestral Harp 2	Harp2
183	Yang Chin	YangChin
184	Timpani	Timpani
185	Timpani 2	Timpani2
186	String Ensembles	Strings
187	String Ensembles 2	Strings2
188	String Ensembles 3	Strings3
189	String Ensembles 4	Strings4
190	Strings & Brass	Str&Bras
191	60's Strings	60'sStr
192	Synth Strings	SynStrs
193	Synth Strings 2	SynStrs2
194	Synth Strings 3	SynStrs3
195	Synth Strings 4	SynStrs4
196	Synth Strings 5	SynStrs5
197	Choir Aahs	ChoirAah
198	Choir Aahs 2	ChorAah2
199	Choir Aahs 3	ChorAah3
200	Voice Oohs	VoiceOoh
201	Voice Oohs 2	VoicOoh2
202	Humming	Humming
203	Anlong Voice	AnlVoice
204	Synth Voice	SynVoice
205	Synth Voice 2	SynVoic2
206	Orchestra Hit	OrchHit
207	Orchestra Hit 2	OrchHit2
208	Bass Hit Plus	BassHit
209	6th Hit	6thHit
210	Euro Hit	EuroHit

VoiceList

Brass		
211	Trumpet	Trumpet
212	Trumpet 2	Trumpet2
213	Dark Trumpet	DarkTrp
214	Trombone	Trombone
215	Trombone 2	Trmbone2
216	Trombone 3	Trmbone3
217	Bright Trombone	BritBone
218	Tuba	Tuba
219	Tuba 2	Tuba2
220	Muted Trumpet	MuteTrp
221	Muted Trumpet 2	MuteTrp2
222	Muted Trumpet 3	MuteTrp3
223	French Horn	FrHorn
224	French Horn 2	FrHorn2
225	French Horn 3	FrHorn3
226	Brass Section	Brass
227	Brass Section 2	Brass2
228	Brass Section 3	Brass3
229	Synth Brass	SynBrass
230	Synth Brass 2	SynBras2
231	Synth Brass 3	SynBras3
232	Synth Brass 4	SynBras4
233	Synth Brass 5	SynBras5
234	Synth Brass 6	SynBras6
235	Synth Brass 7	SynBras7
236	Synth Brass 8	SynBras8
237	Analog Synth Brass	AnaBrass
238	Analog Synth Brass 2	AnaBras2
239	Analog Synth Brass 3	AnaBras3
240	Jump Brass	JumpBras
241	Jump Brass 2	JumpBrs2
242	Funny	Funny
243	Funny 2	Funny2
Reed		
244	Soprano Sax	SprnoSax
245	Soprano Sax 2	SprnSax2
246	Soprano Sax 3	SprnSax3
247	Alto Sax	AltoSax
248	Alto Sax 2	AltoSax2
249	Alto Sax 3	AltoSax3
250	Tenor Sax	TenorSax
251	Tenor Sax 2	TenoSax2
252	Tenor Sax 3	TenoSax3
253	Baritone Sax	BariSax
254	Baritone Sax 2	BariSax2
255	Baritone Sax 3	BariSax3
256	Oboe	Oboe
257	Oboe 2	Oboe2
258	Oboe 3	Oboe3
259	2 Oboes	2Oboes
260	English Horn	EngHorn
261	English Horn 2	EngHorn2
262	English Horn 3	EngHorn3

263	2 English Horns	2EngHons
264	Bassoon	Bassoon
265	Bassoon 2	Bassoon2
266	Bassoon 3	Bassoon3
267	2 Bassoons	2Bassoons
268	Clarinet	Clarinet
269	Clarinet 2	Clarine2
270	Clarinet 3	Clarine3
271	2 Clarinets	2Clarins
Pipe		
272	Piccolo	Piccolo
273	Piccolo 2	Piccolo2
274	Piccolo 3	Piccolo3
275	2 Piccolos	2Piccolos
276	Sweet Flute	SweeFlut
277	Flute	Flute
278	Flute 2	Flute2
279	Flute 3	Flute3
280	2 Flutes	2Flutes
281	Recorder	Recorder
282	Recorder 2	Recorde2
283	2 Recorders	2Records
284	Pan Flute	PanFlute
285	Pan Flute 2	PanFlut2
286	Sweet Pan Flute	SwPanFlu
287	Blown Bottle	Bottle
288	Blown Bottle 2	Bottle2
289	Shakuhachi	Shakhchi
290	Shakuhachi 2	Shakhch2
291	Whistle	Whistle
292	Whistle 2	Whistle2
293	Ocarina	Ocarina
294	Ocarina 2	Ocarina2
Synth Lead		
295	Lead 1 (square)	SquareLd
296	Lead 1a (square) 2	SquarLd2
297	Lead 1 (square) 3	SquarLd3
298	Lead 1b (sine)	SineLead
299	Lead 2 (sawtooth)	SawLead
300	Lead 2a (sawtooth) 2	SawLead2
301	Lead 2 (sawtooth) 3	SawLead3
302	Lead 2b (saw + pulse)	SawPlsLd
303	Lead 2c (double sawtooth)	DubSawLd
304	Lead 2d (sequenced analog)	SquAnaLd
305	Lead 2d (sequenced analog) 2	SqAnaLd2
306	Wavy Sawtooth	WavySaw
307	Bauble Lead	BaubleLd
308	Super Analog	SuperAna
309	Lead 3 (calliope)	CaliopLd
310	Lead 3 (calliope) 2	CalipLd2
311	Lead 4 (chiff)	ChiffLd
312	Lead 4 (chiff) 2	ChiffLd2
313	Lead 4 (chiff) 3	ChiffLd3
314	Lead 5 (charang)	CharanLd

VoiceList

315	Lead 5 (charang) 2	CharaLd2
316	Lead 5 (charang) 3	CharaLd3
317	Lead 5 (charang) 4	CharaLd4
318	Lead 5a (wire lead)	WireLead
319	Lead 5a (wire lead) 2	WireLd2
320	Lead 6 (voice)	VoiceLd
321	Lead 6 (voice) 2	VoiceLd2
322	Lead 7 (fifths)	FifthsLd
323	Lead 7 (fifths) 2	FifthLd2
324	Lead 8 (bass + lead)	BassLead
325	Lead 8 (bass + lead) 2	BasLead2
326	Lead 8 (bass + lead) 3	BasLead3
327	Lead 8a (soft wrl)	SftWrlLd
328	Massiness	Massin
329	Square	Square
330	Slow Square Lead	SlwSquLd
331	Sine Solo	SineSolo
332	Square Lead 4	SquarLd4
333	Thick Square	ThickSqu
334	2Oscillators Lead	2OscLd
335	Wavy Sawtooth 2	WavySaw2
336	Analog Lead	AnaLead
337	Big Lead	BigLead
338	Fat Lead	FatLead
339	PWM 4th	Rezz4th
340	Delayed Lead	DelyLead
341	Delayed Lead 2	DlyLead2
342	Fifth Lead	FifLead
343	Corrie	Corrie
344	Quint	Quint
Synth Pad		
345	Pad 1 (new age)	NewAge
346	Pad 1 (new age) 2	NewAge2
347	Pad 2 (warm)	WarmPad
348	Pad 2 (warm) 2	WarmPad2
349	Pad 2a (sine pad)	SinePad
350	Pad 3 (polysynth)	PolySyn
351	Pad 3 (polysynth) 2	PolySyn2
352	Pad 3 (polysynth) 3	PolySyn3
353	Pad 3 (polysynth) 4	PolySyn4
354	Pad 4 (choir)	ChoirPad
355	Pad 4 (choir) 2	ChoirPd2
356	Pad 4a (itopia)	ItopiaPd
357	Pad 5 (bowed)	BowedPad
358	Pad 5 (bowed) 2	BowedPd2
359	Pad 6 (metallic)	MetalPad
360	Pad 6 (metallic) 2	MetalPd2
361	Pad 7 (halo)	HaloPad
362	Pad 7 (halo) 2	HaloPad2
363	Pad 8 (sweep)	SweepPad
364	Pad 8 (sweep) 2	SweepPd2
365	Pad 8 (sweep) 3	SweepPd3
366	Pan Pad	PanPad
367	Pan Pad 2	PanPad2

368	Dipolar Pad	DipolPad
369	PWM Pad	PWMPad
370	Warmly Pad	WarmlyPd
371	Horn Pad	HornPad
372	Click Pad	ClickPad
373	Analog Pad	AnalogPd
374	80's Poly Pad	80'sPoly
375	PWM 4th Soft	Rezz4thS
376	Synth Calliope Soft	CalioLdS
377	Soft Vox	SoftVox
378	5th SawWave	5thSaw
379	5th Lead Soft	FiftLdSf
380	Slow Square	SISquare
381	New Year Pad	NewYear
382	Space Voice	SpcVoice
383	Rising	Rising
384	Congregate	Congrega
Synth SFX		
385	FX 1 (rain)	FXRain
386	FX 1 (rain) 2	FXRain2
387	FX 2 (soundtrack)	Soundtrk
388	FX 2 (soundtrack) 2	Sondtrk2
389	Prelude	Prelude
390	FX 3 (crystal)	Crystal
391	FX 3 (crystal) 2	Crystal2
392	FX 3a (synth mallet)	SynMalet
393	FX 4 (atmosphere)	Atmosphr
394	FX 4 (atmosphere) 2	Atmosph2
395	Warm Air	WarmAir
396	FX 5 (brightness)	Bright
397	Smog	Smog
398	FX 6 (goblins)	Goblins
399	FX 6 (goblins) 2	Goblins2
400	Choir Bell	ChorBell
401	Choir Bell 2	ChorBel2
402	FX 7 (echoes)	Echoes
403	FX 7 (echoes) 2	Echoes2
404	FX 7b (echo pan)	EchoPan
405	FX 7a (echo bell)	EchoBell
406	FX 7a (echo bell) 2	EchoBel2
407	FX 7a (echo bell) 3	EchoBel3
408	FX 8 (sci-fi)	Sci-Fi
409	FX 8 (sci-fi) 2	Sci-Fi2
Ethnic Misc.		
410	Sitar	Sitar
411	Sitar 2	Sitar2
412	Banjo	Banjo
413	Banjo 2	Banjo2
414	Shamisen	Shamisen
415	Shamisen 2	Shamise2
416	Koto	Koto
417	Koto 2	Koto2
418	Taisho Koto	TaishoKt
419	Kalimba	Kalimba

VoiceList

420	Kalimba 2	Kalimba2
421	Bag Pipe	BagPipe
422	Bag Pipe 2	BagPipe2
423	Fiddle	Fiddle
424	Fiddle 2	Fiddle2
425	Fiddle 3	Fiddle3
426	Shanai	Shanai
427	Shanai 2	Shanai2
Percussive		
428	Tinkle Bell	TnkIBell
429	Agogo	Agogo
430	Steel Drums	SteelDrm
431	Woodblock	WoodBlok
432	Castanets	Castanet
433	Taiko Drum	TaikoDrm
434	Concert Bass Drum	ConBasDm
435	Acoustic Bass Drum	BassDrum
436	Jazz Kick	JazzKick
437	Side Stick	SidStick
438	Analog Rim Shot	AnRiShot
439	Acoustic Snare	A.Snare
440	Jazz Snare	JazSnare
441	Brush Tap	SrushTap
442	Concert SD	ConcetSD
443	Hand Clap	HandClap
444	Tom	Tom
445	Brush Tom	BrushTom
446	Closed Hi-hat	ClosedHH
447	Analog Closed Hi-hat	AnCloHH
448	Pedal Hi-hat	PedalHH
449	Open Hi-hat	OpenHH
450	Crash Cymbal	CrashCym
451	Analog Cymbal	AnaCym
452	Ride Cymbal	RideCym
453	China Cymbal	ChinaCym
454	Ride Bell	RideBell
455	Tambourine	Tambouri
456	Splash Cymbal	SplashCy
457	Cowbell	Cowbell
458	Analog Cowbell	AnaCowbl
459	High Bongo	HiBongo
460	Low Bongo	LoBongo
461	Mute Hi Conga	MuHiCnga
462	Open Hi Conga	OpHiCnga
463	Low Conga	LowConga
464	Analog Hi Conga	AnHiCnga
465	Analog Mid Conga	AnMiCnga
466	Analog Low Conga	AnLoCnga
467	High Timbale	HiTimbal
468	Low Timbale	LoTimbal
469	Cabasa	Cabasa
470	Maracas	Maracas
471	Analog Maracas	AnMaracas
472	Short Guiro	ShGuiro

473	Long Guiro	LoGuiro
474	Claves	Claves
475	Mute Cuica	MuCuica
476	Open Cuica	OpCuica
477	Mute Triangle	MuTrgle
478	Open Triangle	OpTrgle
479	Shaker	Shaker
480	Mute Surdo	MuSurdo
481	Open Surdo	OpSurdo
482	Melodic Tom	MeloTom
483	Melodic Tom 2	MeloTom2
484	Synth Drum	SynDrum
485	Rhythm Box Tom	RhythBox
486	Electric Drum	ElecDrum
487	Reverse Cymbal	RevCymbI
SFX		
488	Guitar Fret Noise	FretNoiz
489	Guitar Cutting Noise	GtCtNoiz
490	Acoustic Bass String Slap	BsStSlap
491	Breath Noise	BrthNoiz
492	Flute Key Click	FlKeyClk
493	Seashore	Seashore
494	Rain	Rain
495	Thunder	Thunder
496	Wind	Wind
497	Stream	Stream
498	Bubble	Bubble
499	Bird Tweet	Tweet
500	Bird Tweet 2	Tweet2
501	Dog	Dog
502	Horse Gallop	HouseGlp
503	Telephone Ring	Telephone
504	Telephone Ring 2	Telphon2
505	Door Creaking	DoorCrek
506	Door	Door
507	Scratch	Scratch
508	Wind Chime	WindChim
509	Helicopter	Helicptr
510	Car Engine	CarEngin
511	Car Stop	CarStop
512	Car Pass	CarPass
513	Car Crash	CarCrash
514	Siren	Siren
515	Train	Train
516	Jetplane	Jetplane
517	Starship	Starship
518	Burst Noise	BurtNois
519	Applause	Applause
520	Laughing	Laughing
521	Screaming	Scream
522	Punch	Punch
523	Heart Beat	HeartBet
524	Footsteps	Footstep
525	Gunshot	Gunshot

VoiceList

526	Machine Gun	MachnGun
527	Lasergun	Lasergun
528	Explosion	Explosio
Combined Voice		
529	Stereo Piano & Strings Pad	Pn&StrPd
530	Stereo Piano & Choir	Pn&Choir
531	Stereo Piano & Synth Strings	Pn&SyStr
532	Stereo Piano & Warm Pad	Pn&WrmPd
533	Stereo Piano & Soft EP	Pn&SfEP
534	FM Electric Piano	FMEP
535	Digital Piano	DigitlPn
536	E.Piano & Strings	EP&Str
537	E.Piano & Acoustic Guitar	EP&Gtr
538	E.Piano & Vibraphone	EP&Vibra
539	E.Piano 2 & Pad	EP2&Pad
540	E.Piano 2 & Strings	EP2&Str
541	Harpichord & Stereo Strings	Hrps&Str
542	Music Box & Stereo Strings	MBox&Str
543	Vibraphone & Stereo Strings	Vib&Str
544	Vibraphone Octave	VibraOct
545	Vibraphone & Marimba & Kalimba	Vib&M&K
546	Marimba & Kalimba	Mar&Kal
547	Marimba Delay	MarDelay
548	Xylophone Octave	XylopOct
549	Organ & Stereo Strings	Orgn&Str
550	Stereo Organ & Piano	Orgn&Pno
551	Rock Organ & Strings	RkOr&Str
552	Church Organ & Choir	ChOr&Cho
553	Church Organ & Strings	ChOr&Str
554	Acoustic Guitar & Flute	Gtr&Flut
555	Acoustic Guitar & Clavi	Gtr&Clav
556	24 String Guitar	24StrGtr
557	Steel Guitar & Warm Pad	StGt&Pad
558	Stereo Strings & Horn	Str&Horn
559	Orchestra	Orchestr
560	Full Strings	FullStr
561	Full Strings 2	FullStr2
562	Symphonic	Symphon
563	Stereo Choir & Strings	Cho&Str
564	Stereo Choir & Steel Guitar	Cho&Gtr
565	3 Trumpet Loose	3Trumpet
566	Trombone & Stereo Strings	Tomb&Str
567	3 Trombones Loose	3Trmbone
568	3 Muted Trumpets Loose	3MuTrump
569	Club Brass	ClubBras
570	Brass & Woodwinds	Brs&Wood
571	Woodwinds & Strings	Wood&Str
572	Section Woods Small	WoodSmal
573	Pan Flute & Strings Pad	PnFl&Str
574	Koto & Shamisen	Kto&Sham
575	Flute & Clarinet	Flu&Clar
576	Flute & Oboe	Flu&Oboe
577	Flute & Bassoon	Flu&Bn
578	Flute & Oboe & Clarinet	Fl&Ob&Cl

579	Flute & Clarinet & Bassoon	Fl&Cl&Bn
580	Flute & Oboe & Bassoon	Fl&Ob&Bn
581	Flute Octave	FluteOct
582	Flute & Oboe Octave	Fl&ObOct
583	Flute & Clarinet Octave	Fl&ClOct
584	Oboe & Bassoon	Oboe&Bn
585	Oboe & Clarinet	Ob&Cl
586	Oboe & Clarinet & Bassoon	Ob&Cl&Bn
587	Oboe Octave	OboeOct
588	Oboe & Clarinet Octave	Ob&ClOct
589	Oboe & Bassoon Octave	Ob&BnOct
590	Clarinet & Bassoon	Cl&Bn
591	Clarinet & Oboe Octave	Cl&ObOct
Chinese Instruments		
592	Standard Set	StandSet
593	Room Set	RoomSet
594	Power Set	PowerSet
595	Electronic Set	ElectSet
596	Analog Set	AnalgSet
597	Jazz Set	JazzSet
598	Brush Set	BrushSet
599	Orchestra Set	OrcheSet
600	SFX Set	SFXSet

StyleList

NO.	English Name	LCD Name
8BEAT		
1	8Beat Ballad	8BtBld
2	8Beat Piano	8BtPiano
3	8Beat 1	8Beat1
4	Guitar Pop 1	GtPop1
5	8Beat Hip Hop	8BtHiHop
6	8Beat Blues Rock	8BtBluRk
7	8Beat 2	8Beat2
8	Sweet Beat	SweetBt
9	8Beat 3	8Beat3
10	Rhythm&Beat 2	Rhy&Bt2
16BEAT		
11	16Beat 1	16Beat1
12	16Beat Funk 1	16BtFuk1
13	16Beat Ballad 1	16BtBld1
14	16Beat R&B	16BtR&B
15	Pop 16Beat 1	Pop16Bt1
16	16Beat Funk 2	16BtFuk2
17	16Beat Dance	16BtDanc
18	Pop 16Beat 2	Pop16Bt2
19	16Beat 2	16Beat2
20	Pop 16Beat 3	Pop16Bt3
21	Pop 16Beat 4	Pop16Bt4
22	Modern 16Beat	Modr16Bt
23	16Beat Hot	16BtHot
24	16Beat Modern	16BtModr
25	16Beat Funk 3	16BtFuk3
26	16Beat 3	16Beat3
27	Cool Beat	CoolBeat
28	16Beat Ballad 2	16BtBld2
29	16Beat 4	16Beat4
30	Pop Shuffle	PopShfl
POP&BALLAD		
31	Pop Rock 1	PopRock1
32	Pop Dance 1	PopDanc1
33	Pop Fusion	PopFusn
34	Analog Night 1	AnalgNt1
35	6/8 Pop	6/8Pop
36	Brit. Pop 1	BritPop1
37	Brit. Pop 2	BritPop2
38	Pop Hit	PopHit
39	Fusion Shuffle	FusShufl
40	Analog Night 2	AnalgNt2
41	Guitar Pop 3	GtPop3
42	Pop Beat	PopBeat
43	Soft Beat	SoftBeat
44	60's Pop	60'sPop
45	Sting Latin	StigLatn
46	R&B Ballad 1	R&BBld1
47	Guitar Ballad	GtBallad
48	Ballad Rock	BaldRock
49	Piano Pop	PianoPop
50	Soft Ballad	SoftBald
51	Natural Ballad	NatuiBld
52	Love Ballad	LoveBald

53	Easy Ballad	EasyBald
54	Miami Folk	MiamiBld
55	Slow Ballad	SlowBald
56	Folk Ballad	FolkBald
57	Pop Ballad 1	PopBald1
58	Pop Ballad 2	PopBald2
59	EP Ballad	EPBallad
60	New R&B Ballad	NewRBBld
ROCK		
61	Rock	Rock
62	New Wave	NewWave
63	Ska	Ska
64	Pop Rock 2	PopRock2
65	Slow Rock	SlowRock
66	70's Rock&Roll	70'sRock
67	Folk Rock	FolkRock
68	Soft Rock	SoftRock
69	Old Rock	OldRock
70	Easy Rock	EasyRock
71	New Shuffle	NewShufl
72	Rock Hip Hop	RkHipHop
73	Rock&Roll 1	R'N'R1
74	Rock Shuffle	RockShfl
75	Rock&Roll 2	R'N'R2
BALLROOM		
76	Tango 1	Tango1
77	Spain Matador	Matador
78	Twist 1	Twist1
79	Twist 2	Twist2
80	Big Band Fox	BandFox
81	Tango 2	Tango2
82	Slow Fox	SlowFox
83	Slow Waltz 1	SlowWlzl1
84	Swing Fox	SwingFox
85	Salsa 1	Salsa1
86	Cha Cha 1	ChaCha1
87	Cha Cha 2	ChaCha2
88	Beguine 1	Beguine1
89	Beguine 2	Beguine2
90	Rumba 1	Rumba1
91	Samba 1	Samba1
92	Samba 2	Samba2
93	Jive	Jive
94	Fox Trot	FoxTrot
DANCE		
95	Techno 1	Techno1
96	Hip Hop 1	HipHop1
97	House 1	House1
98	Down Beat	DownBeat
99	Progressive	Progress
100	Rap 1	Rap1
101	Disco	Disco
102	70's Disco	70'sDisc
103	Club Dance	ClubDanc
104	Euro Dance	EuroDanc
105	Garage	Garage

StyleList

SOUL & FUNK		
106	Funk 1	Funk1
107	Classic Funk	ClasFunk
108	Jay R&B	JayR&B
109	Gospel Swing	GopSwing
110	Gospel	Gospel
111	Funk 2	Funk2
112	Electric Funk	ElecFunk
113	Groove Funk	GrooveFk
114	Rubber Funk	RubberFk
115	Cool Funky	ColFunky
116	Jazz Funk	JazzFunk
117	Groove	Groove
118	Soul	Soul
119	Hip Hop Soul	HipHopSl
120	Hip Hop Beat	HipHopBt
121	R&B	R&B
122	British Soul Pop	BritSoul
123	Latin Jazz 1	LatinJz1
124	Big Band 1	BigBand1
125	Dixieland 1	Dixland1
126	Guitar Swing 1	GtSwing1
127	Broadway Big Band	BwayBand
128	Swing	Swing
129	Latin Jazz 2	LatinJz2
130	Fusion	Fusion
131	Acid Jazz	AcidJazz
132	Cool Jazz Ballad	CoolJzBd
133	Swing Shuffle	SwingSfl
134	Big Band Medium	BandMid
135	Ragtime	Ragtime
COUNTRY		
136	Country Pop 1	CntyPop1
137	Bluegrass 1	Blugas1
138	8Beat Country	8BtCnty
139	Modern Country	ModrCnty
140	Country Pop 2	CntyPop2
141	Bluegrass 2	Blugas2
142	2/4 Country	2/4Cntry
143	Country Quick Steps	QuickStp
144	Country Folk	CntyFolk
145	Country Shuffle	CnyShufl
LATIN&LATIN DANCE		
146	Samba 3	Samba3
147	Bossa Nova	BosaNova
148	Latin	Latin
149	New Reggae	NewRegga
150	Reggae Dance	DanRegga
151	Paso Doble	Pasodobl
152	Lite Bossa	LteBossa
153	Latin Rock	LatinRck
154	Beguine 3	Beguine3
155	Slow Bolero	SIBolero
156	Disco Samba	DscSamba
157	Mambo	Mambo
158	Meneito	Meneito

159	Rumba 2	Rumba2
160	Rumba 3	Rumba3
161	Lambada	Lambada
162	Pop Cha Cha 1	PChaCha1
WALTZ&TRADITIONAL		
163	Waltz	Waltz
164	Old Waltz	OldWaltz
165	English Waltz	EngWaltz
166	German Waltz	GemWaltz
167	Italian Mazurka	ItaMazuk
168	Mexico Waltz	MexWaltz
169	Vienna Waltz	VinaWltz
170	Slow Waltz 2	SlwWltz2
171	Jazz Waltz	JazzWltz
172	Polka	Polka
173	6/8 March	6/8March
174	German Polka	GemPolka
175	Party Polka	PtyPolka
176	Army March	ArmMarch
177	March	March
178	US March	USMarch
179	French Musette	FMusette
180	Mazurka	Mazurka
WORLD		
181	Enka Ballad	EnkaBald
182	Laendler	Laendler
183	Hawaiian	Hawaiian
184	Sirtake	Sirtake
185	Dangdut	Dangdut
186	6/8 Flipper	6/8Flipp
187	New Age	NewAge
188	Tarantella	Tarantel
189	Scottish	Scottish
190	Norteno	Norteno
PIANIST		
191	Pianist 1	Pianist1
192	Pianist 2	Pianist2
193	Pianist 3	Pianist3
194	March 1	March1
195	Italian Polka	ItaPolka
196	Slow Waltz	SlwWltz
197	Waltz 1	Waltz1
198	Waltz 2	Waltz2
199	Waltz 3	Waltz3
200	Vienna Waltz	VinaWtz
201	Latin	Latin
202	Tango	Tango
203	Lambada	Lambada
204	Samba	Samba
205	ChaCha	ChaCha
206	Beguine	Beguine
207	Salas	Salas
208	Pop Bossa	PopBossa
209	Jazz 1	Jazz1
210	Jazz 2	Jazz2
211	Jazz 3	Jazz3

212	Jazz 4	Jazz4
213	Jazz 5	Jazz5
214	Jazz 6	Jazz6
215	Jazz 7	Jazz7
216	Boogie	Boogie
217	Jive	Jive
218	Dixland	Dixland
219	Blues 1	Blues1
220	Blues 2	Blues2
221	Jazz Bluse	JazBluse
222	Pop 1	Pop1
223	Pop 2	Pop2
224	Pop 3	Pop3
225	Pop 4	Pop4
226	Ballad 1	Ballad1
227	Ballad 2	Ballad2
228	Ballad 3	Ballad3
229	Ballad 4	Ballad4
230	6/8 Ballad 2	6/8Bld2

Song List

NO.	English Name	LCD Name
FOLK & COUNTRY		
1	Toccata	Toccata
2	Carry Me Back To Old Virginny	Virginny
3	El Condor Pasa	ElCondor
4	Traumerei	Traumere
5	Aloha Oe	AlohaOe
6	Greensleeves	Sleeves
7	Home Sweet Home	SwetHome
8	Heidenroslein	Heidenro
9	Long Long Ago	LongAgo
10	Die Lorelei	Lorelei
11	Over The Waves	OverWave
12	My Darling Clementine	Clemtine
13	Gwine To Run All Night	Gwine
14	Symphony No.6 "Pathetic"	Sympony6
15	Oh! Susanna	Susanna
16	Prelude Op.28 No.15	Prelude
17	The House Of The Rising Sun	RiseSun
18	Menuet	Menuet
GOLDEN & POP		
19	Valse Des Fleurs	Fleurs
20	Fruhlingsstimmen	Fruhling
21	Frohlicher Landmann	Landmann
22	Are You Lonesome Tonight?	Lonesome
23	Toy Symphony	ToySymph
24	Auld Lang Syne	LangSyne
25	Ave Maria	AveMaria
26	Tales Of Hoffman	Hoffman
27	La Donne Mobile	DoneMble
28	Serenata	Serenata
29	Bridal March	Bridal
30	Can't Help Fallin' In Love	InLove
31	Chanson Du Toreador	Toreador
32	Danny Boy	DannyBoy
33	Ich Liebe Dich	LieDich
34	Wiegenlied 2	Wieglied2
35	Spanish Serenade	Serenade
36	Piano Concerto	Concerto
37	Piano Concerto 2	Concrcto2
38	Madame Butterfly	Madame
39	Invitation To The Dance	ToDance
40	Wiegenlied 3	Wieglied3
41	Jingle Bells	JingBell
42	Joy To The World	JoyWorld
43	La Paloma	LaPaloma
44	My Bonnie	MyBonnie
45	La Reine De Saba	Saba
46	La Cucaracha	Cucarach
47	Little Brown Jug	BrownJug
48	Battle Hymne Of The Republic	BatlHyme
49	Yellow Rose Of Texas	YellRose
50	The Wabash Cannon Ball	CannBall
51	Annie Laurie	AnnieLa
52	Turkish March	Turkish
53	An Die Musik	Musik
54	Lieder Ohne Worte Op.62 No.6	Lieder

55	Red River Valley	RedRiver
56	Die Forelle	Forelle
57	Symphony No. 94 "Suprise"	No. 94
58	Polonaise	Polonais
59	Rondeau	Rondeau
60	Moments Musicaux	Musicaux
61	Silent Night	SttNight
62	Moldau	Moldau
63	Summertime	Summer
64	Dreaming Of Home And Mother	Dreaming
65	Ring Ring De Banjo	DeBanjo
66	Der Lindenbaum	DerLinde
67	Zigeunerweisen	Zigeuner
68	The Maiden's Prayer	Prayer
69	Fur Elise	FurElise
70	Der Freischutz	DerFreis
71	Maria! Mari!	Maria!
CLASSICAL		
72	Waves Of The Danube	Danube
73	Santa Lucia	SantaLuc
74	Solveig's Song	Solveig
75	Piano Sonatan No. 8 In C Minor (Pathetique)	Patheque
76	Brahms Waltz	BrmsWltz
77	Aida	Aida
78	Carmen-Prelude	Carmen
79	L'Arlesienne	L'Arlesi
80	Ungarische Tanz	Ungaris
81	Mazurka	Mazurka
82	Pizzicato Polka	Polka
83	Menuett	Menuett
84	Rigoletto	Rigoletto
85	Serenade	Serenade
86	Song Without Words	SongNoWd
87	Swan	Swan
88	The Dying Swan	DyingSwn
89	Swan Lake Valse	SwnWalse
90	The Happy Farmer	HpFarmer
91	The Sleeping Beauty	SleepBty
92	La Traviata	LaTravia
93	Wiegenlied	Wiegenli
94	Mov. 2 Adagio Non Troppo Piano Sonata No. 9 In D	Sonata9
95	Piano Sonata No. 11 In A	Sonata11
96	Prelude In C	Prelude
97	Chinese Dance	ChDance
98	Emperor Waltz	Emperor
99	March Militaire	Militair
100	Symphony No. 40	Symphony
PIANO		
101	Hanon Piano Fingering 1	Hanon1
102	Hanon Piano Fingering 2	Hanon2
103	Hanon Piano Fingering 3	Hanon3
104	Hanon Piano Fingering 4	Hanon4
105	Hanon Piano Fingering 5	Hanon5
106	Basic Tutorial Beyer Piano 12	Beyer12
107	Basic Tutorial Beyer Piano 13	Beyer13
108	Basic Tutorial Beyer Piano 14	Beyer14
109	Basic Tutorial Beyer Piano 15	Beyer15

Song List

110	Basic Tutorial Beyer Piano 18	Beyer18
111	Cuckoo	Cuckoo
112	Basic Tutorial Beyer Piano 21	Beyer21
113	Basic Tutorial Beyer Piano 29	Beyer29
114	Butterfly	Buterfly
115	Basic Tutorial Beyer Piano 45	Beyer45
116	Christmas Eve	XmasEve
117	Basic Tutorial Beyer Piano 50	Beyer50
118	Basic Tutorial Beyer Piano 52	Beyer52
119	Basic Tutorial Beyer Piano 55	Beyer55
120	Basic Tutorial Beyer Piano 59	Beyer59

Demo List

NO.	English Name	LCD Name
1	Demo1	Demo1
2	Demo2	Demo2
3	Bossa Nova	BosaNova
4	Fusion	Fusion
5	Jazz	Jazz

MIDI Implementation Chart

Function		Transmitted	Recognized	Remarks
Basic	Default	1ch	ALL	
Channel	Changed	1-16ch	1-16ch	
Mode	Default	x	3	
	Messages	x	3	
	Altered	*****	x	
Note Number	Note	0—127	0—127	
	:True voice	*****	0—127	
Velocity	Note on	o 9nH,V=1-127	o 9nH,V=1-127	
	Note off	x (9nH,V=0)	o(9nH,V=0; 8nH,V=0-127)	
After Touch	key's	x	x	
	Ch's	x	x	
Pitch Bend		o	o	
Control Change	0	o	o	Bank Select
	1	x	o	Modulation
	5	x	o	Portamento Time
	6	o	o	Data Entry
	7	o	o	Volume
	10	x	o	Pan
	11	x	o	Expression
	64	o	o	Sustain Pedal
	65	x	o	Portamento ON/OFF
	66	o	o	Sostenuto Pedal
	67	o	o	Soft Pedal
	80	x	o	Reverb Program
	81	x	o	Chorus Program
	91	o	o	Reverb Level
	93	o	o	Chorus Level
	120	x	o	All Sound Off
121	x	o	Reset All Controllers	
123	x	o	All Notes Off	
Program Change	:true	*****	0—127	
System Exclusive		x	o	
System Common	:SongPosition	x	x	
	:Song Select	x	x	
	:Tune	x	x	
System Real Time	:Clock	o	x	
	:Commands	x *1	x *1	
Aux Messages	:LOCAL ON/OFF	x	x	
	:Active sense	x	o	
	:Reset	x	x	
Notes: *1		When the accompaniment is started, an FAH message is transmitted. When accompaniment is stopped, an FCH message is transmitted.		

- Mode 1: OMNI ON, POLY
- Mode 2: OMNI ON, MONO

- Mode 3: OMNI OFF, POLY
- Mode 4: OMNI OFF, MONO

- o: YES
- x: NO

