

# Owner's Manual

Guitar Amplifier



KATANA-50MkII  
KATANA-100 Mk II  
KATANA-100/212 Mk II  
KATANA-HEAD Mk II  
KATANA-Artist Mk II

This Owner's Manual applies to the KATANA-50 Mk II, KATANA-100 Mk II, KATANA-100/212 Mk II, KATANA-HEAD Mk II, and KATANA-Artist Mk II. Explanations for specific models are distinguished by an icon (example: **100/212, HEAD only**).



## KATANA-50 Mk II

KTN-50 2

50 W output, 30 cm (12 inch) speaker



## KATANA-100 Mk II

KTN-100 2

100 W output, 30 cm (12 inch) speaker



## KATANA-100/212 Mk II

KTN-212 2

100 W output, 30 cm (12 inch) speaker x 2



## KATANA-HEAD Mk II

KTN-HEAD 2

100 W output, 12 cm (5 inch) speaker



## KATANA-Artist Mk II

KTN-ART 2

100 W output, 30 cm (12 inch) speaker

English

日本語

Deutsch

Français

Italiano

Español

Português

Nederlands



# USING THE UNIT SAFELY

Before using this unit, carefully read "IMPORTANT SAFETY INSTRUCTIONS" (inside front cover), "USING THE UNIT SAFELY" (p. 2), and "IMPORTANT NOTES" (p. 3). After reading, keep the document(s) where it will be available for immediate reference.







© 2019 Roland Corporation

## INSTRUCTIONS FOR THE PREVENTION OF FIRE, ELECTRIC SHOCK, OR INJURY TO PERSONS

About  WARNING and  CAUTION Notices

 <b>WARNING</b>	Used for instructions intended to alert the user to the risk of death or severe injury should the unit be used improperly.
 <b>CAUTION</b>	Used for instructions intended to alert the user to the risk of injury or material damage should the unit be used improperly. * Material damage refers to damage or other adverse effects caused with respect to the home and all its furnishings, as well to domestic animals or pets.

About the Symbols

	The  symbol alerts the user to important instructions or warnings. The specific meaning of the symbol is determined by the design contained within the triangle. In the case of the symbol at left, it is used for general cautions, warnings, or alerts to danger.
	The  symbol alerts the user to items that must never be carried out (are forbidden). The specific thing that must not be done is indicated by the design contained within the circle. In the case of the symbol at left, it means that the unit must never be disassembled.
	The  symbol alerts the user to things that must be carried out. The specific thing that must be done is indicated by the design contained within the circle. In the case of the symbol at left, it means that the power-cord plug must be unplugged from the outlet.

### ALWAYS OBSERVE THE FOLLOWING

#### WARNING

##### Make sure that the power cord is grounded

Connect mains plug of this model to a mains socket outlet with a protective earthing connection.



##### To completely turn off power to the unit, pull out the plug from the outlet

Even with the power switch turned off, this unit is not completely separated from its main source of power. When the power needs to be completely turned off, turn off the power switch on the unit, then pull out the plug from the outlet. For this reason, the outlet into which you choose to connect the power cord's plug should be one that is within easy reach and readily accessible.



##### Secure a sufficient amount of space at the setup location

Since this unit normally emits a slight amount of heat, make sure to secure sufficient space around it, as shown below.

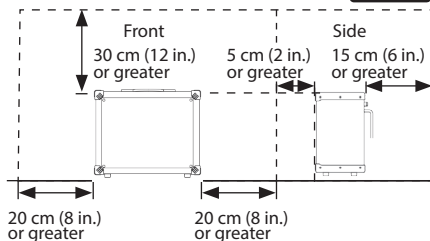

##### Do not disassemble or modify by yourself

Do not carry out anything unless you are instructed to do so in the owner's manual. Otherwise, you risk causing malfunction.



##### Do not repair or replace parts by yourself

Be sure to contact your dealer, a Roland service center, or an official Roland dealer. For a list of Roland service centers and official Roland dealers, refer to the Roland website.



#### WARNING

##### Do not use or store in the following types of locations

- Subject to temperature extremes (e.g., direct sunlight in an enclosed vehicle, near a heating duct, on top of heat-generating equipment); or are
- Damp (e.g., baths, washrooms, on wet floors); or are
- Exposed to steam or smoke; or are
- Subject to salt exposure; or are
- Exposed to rain; or are
- Dusty or sandy; or are
- Subject to high levels of vibration and shakiness; or are
- Placed in a poorly ventilated location.



##### Do not place in an unstable location

Otherwise, you risk injury as the result of the unit toppling over or dropping down.



##### Connect the power cord to an outlet of the correct voltage

The unit should be connected to a power supply only of the type described as marked on the rear side of unit.



##### Use only the supplied power cord

Use only the attached power cord. Also, the supplied power cord must not be used with any other device.



##### Do not bend the power cord or place heavy objects on it

Otherwise, fire or electric shock may result.



##### Avoid extended use at high volume

Use of the unit at high volume for extended periods of time may cause hearing loss. If you ever experience any hearing loss or ringing in the ears, you should immediately stop using the unit and consult a specialized physician.



#### WARNING

##### Do not allow foreign objects or liquids to enter unit; never place containers with liquid on unit

Do not place containers containing liquid (e.g., flower vases) on this product. Never allow foreign objects (e.g., flammable objects, coins, wires) or liquids (e.g., water or juice) to enter this product. Doing so may cause short circuits, faulty operation, or other malfunctions.



##### Turn off the unit if an abnormality or malfunction occurs

In the following cases, immediately turn off the power, remove the power cord from the outlet, and contact your dealer, a Roland service center, or an official Roland dealer for service.



- The power cord has been damaged; or
- If smoke or unusual odor occurs; or
- Objects have fallen into, or liquid has been spilled onto the unit; or
- The unit has been exposed to rain (or otherwise has become wet); or
- The unit does not appear to operate normally or exhibits a marked change in performance.

For a list of Roland service centers and official Roland dealers, refer to the Roland website.

##### Be cautious to protect children from injury

Always make sure that an adult is on hand to provide supervision and guidance when using the unit in places where children are present, or when a child will be using the unit.



##### Do not drop or subject to strong impact

Otherwise, you risk causing damage or malfunction.



##### Do not share an outlet with an unreasonable number of other devices

Otherwise, you risk overheating or fire.



##### Do not use overseas

Before using the unit in overseas, consult with your retailer, the nearest Roland service center, or an authorized Roland distributor.



For a list of Roland service centers and official Roland dealers, refer to the Roland website.

##### Don't block ventilation openings

Don't allow the unit's ventilation openings to be blocked by a newspaper, tablecloth, curtains, or similar objects.



##### Don't place burning objects on the unit

Don't place any burning object (such as a candle) on the unit.



##### Be aware of weather conditions

Use the apparatus in moderate climates.



**⚠ CAUTION**

**When disconnecting the power cord, grasp it by the plug**

To prevent conductor damage, always grasp the power cord by its plug when disconnecting it.



**Periodically clean the power plug**

An accumulation of dust or foreign objects between the power plug and the power outlet can lead to fire or electric shock.



At regular intervals, be sure to pull out the power plug, and using a dry cloth, wipe away any dust or foreign objects that may have accumulated.

**Disconnect the power plug whenever the unit will not be used for an extended period of time**

Fire may result in the unlikely event that a breakdown occurs.



**⚠ CAUTION**

**Route all power cords and cables in such a way as to prevent them from getting entangled**

Injury could result if someone were to trip on a cable and cause the unit to fall or topple.



**Avoid climbing on top of the unit, or placing heavy objects on it**

Otherwise, you risk injury as the result of the unit toppling over or dropping down.



**Never connect/disconnect a power plug if your hands are wet**

Otherwise, you could receive an electric shock.



**Disconnect all cords/cables before moving the unit**

Before moving the unit, disconnect the power plug from the outlet, and pull out all cords from external devices.



**⚠ CAUTION**

**Before cleaning the unit, disconnect the power plug from the outlet**

If the power plug is not removed from the outlet, you risk receiving an electric shock.



**Whenever there is a threat of lightning, disconnect the power plug from the outlet**

If the power plug is not removed from the outlet, you risk causing malfunction or receiving an electric shock.



English

日本語

Deutsch

Français

Italiano

Español

Português

Nederlands

# IMPORTANT NOTES

## Power Supply

- Do not connect this unit to same electrical outlet that is being used by an electrical appliance that is controlled by an inverter or a motor (such as a refrigerator, washing machine, microwave oven, or air conditioner). Depending on the way in which the electrical appliance is used, power supply noise may cause this unit to malfunction or may produce audible noise. If it is not practical to use a separate electrical outlet, connect a power supply noise filter between this unit and the electrical outlet.

## Placement

- Using the unit near power amplifiers (or other equipment containing large power transformers) may induce hum. To alleviate the problem, change the orientation of this unit; or move it farther away from the source of interference.
- This unit may interfere with radio and television reception. Do not use this unit in the vicinity of such receivers.
- Noise may be produced if wireless communications devices, such as cell phones, are operated in the vicinity of this unit. Such noise could occur when receiving or initiating a call, or while conversing. Should you experience such problems, you should relocate such wireless devices so they are at a greater distance from this unit, or switch them off.
- When moved from one location to another where the temperature and/or humidity is very different, water droplets (condensation) may form inside the unit. Damage or malfunction may result if you attempt to use the unit in this condition. Therefore, before using the unit, you must allow it to stand for several hours, until the condensation has completely evaporated.
- Depending on the material and temperature of the surface on which you place the unit, its rubber feet may discolor or mar the surface.
- Do not place containers or anything else containing liquid on top of this unit. Also, whenever any liquid has been spilled on the surface of this unit, be sure to promptly wipe it away using a soft, dry cloth.

## Maintenance

- Never use benzene, thinners, alcohol or solvents of any kind, to avoid the possibility of discoloration and/or deformation.

## Repairs and Data

- Before sending the unit away for repairs, be sure to make a backup of the data stored within it; or you may prefer to write down the needed information. Although we will do our utmost to preserve the data stored in your unit when we carry out repairs, in some cases, such as when the memory section is physically damaged, restoration of the stored content may be impossible. Roland assumes no liability concerning the restoration of any stored content that has been lost.

## Additional Precautions

- Any data stored within the unit can be lost as the result of equipment failure, incorrect operation, etc. To protect yourself against the irretrievable loss of data, try to make a habit of creating regular backups of the data you've stored in the unit.
- Roland assumes no liability concerning the restoration of any stored content that has been lost.
- Use a reasonable amount of care when using the unit's buttons, sliders, or other controls; and when using its jacks and connectors. Rough handling can lead to malfunctions.
- When disconnecting all cables, grasp the connector itself—never pull on the cable. This way you will avoid causing shorts, or damage to the cable's internal elements.
- A small amount of heat will radiate from the unit during normal operation.
- To avoid disturbing others nearby, try to keep the unit's volume at reasonable levels.
- Use only the specified expression pedal. By connecting any other expression pedals, you risk causing malfunction and/or damage to the unit.
- Do not use connection cables that contain a built-in resistor.

## Intellectual Property Right

- Roland and BOSS are either registered trademarks or trademarks of Roland Corporation in the United States and/or other countries.
- ASIO is a trademark and software of Steinberg Media Technologies GmbH.
- This product contains eParts integrated software platform of eSOL Co.,Ltd. eParts is a trademark of eSOL Co., Ltd. in Japan.
- Company names and product names appearing in this document are registered trademarks or trademarks of their respective owners.

# Panel Descriptions

## Top Panel

### KATANA-50 Mk II, KATANA-100 Mk II, KATANA-100/212 Mk II, KATANA-HEAD Mk II Top Panel

\* The illustration shows the KATANA-HEAD Mk II. KATANA-50 Mk II does not have a PRESENCE knob, [CAB RESONANCE] switch, nor does it have TONE SETTING buttons CH3 and CH4.

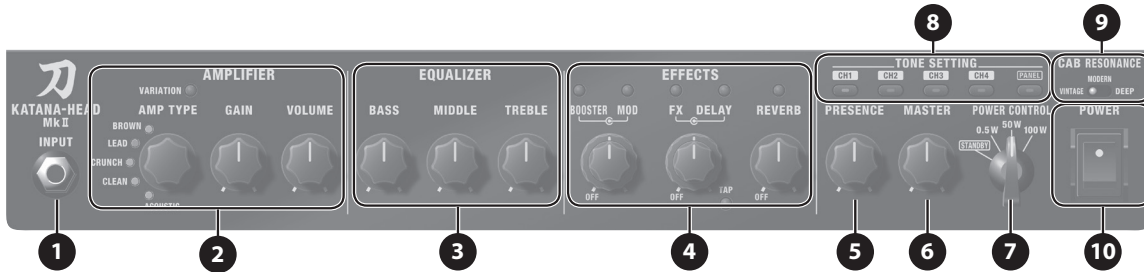

### KATANA-Artist Mk II Front Panel

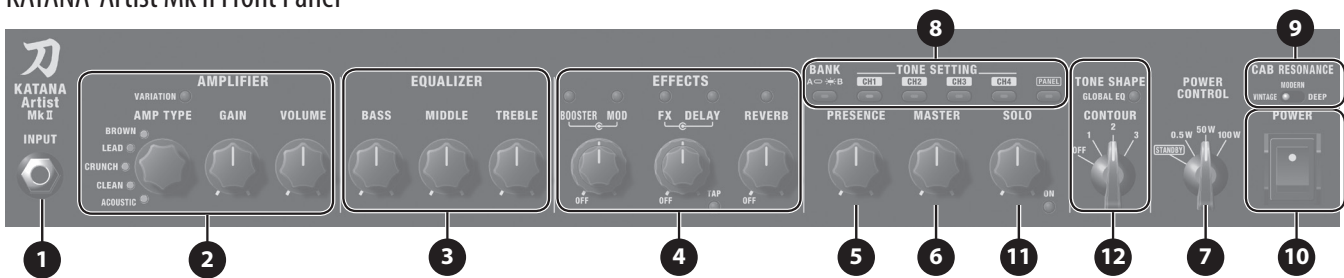

#### 1 INPUT jack

Connect your electric guitar here.

#### 2 AMPLIFIER

##### [AMP TYPE] knob

Selects the amp type. All provided amp types are original.

Type	Explanation
BROWN	A lead sound with an edge inherited from the BOSS WAZA brown sound.
LEAD	Different gain settings allow this sound to cover a wide range from crunch to high-gain.
CRUNCH	A fat crunch sound that faithfully responds to the nuances of your picking.
CLEAN	A clean and natural sound. In conjunction with BOOSTER, it can be used for solo or lead.
ACOUSTIC	A dedicated acoustic guitar amp that supports connection of an acoustic guitar.

##### [VARIATION] button

Switches the AMP TYPE variation.

##### [GAIN] knob

Adjusts the gain (amount of distortion).

##### [VOLUME] knob

Adjusts the volume.

#### 3 EQUALIZER

##### [BASS] knob

Adjusts the sound level of the low-frequency range.

##### [MIDDLE] knob

Adjusts the sound level of middle-frequency range.

##### [TREBLE] knob

Adjusts the sound level of the high-frequency range.

#### 4 EFFECTS

Here you can make settings for the built-in effects. For details on the effect types and settings for each knob, refer to "Using the Effects" (p. 10).

##### [BOOSTER] button/knob

Controls distortion-type effects.

##### [MOD] button/knob

Controls modulation effects.

##### [FX] button/knob

Controls effects such as wah, tremolo, and octave.

##### [DELAY] button/knob

Controls delay effect.

##### [TAP] button

Sets the delay time. When you press this button two or more times, the delay time is set to the interval between presses.

##### [REVERB] button/knob

Controls the reverb.

#### 5 [PRESENCE] knob 100, 100/212, HEAD, Artist only

Adds lustrous outline to the mid- and high-frequency range. This is effective when you want to improve the definition of the sound.

#### 6 [MASTER] knob

Adjusts the overall volume.

#### 7 [POWER CONTROL] switch

Lets you switch the output level of the power amp according to your location or needs. By selecting "STANDBY" you can mute the sound while leaving the unit powered-on. This lets you mute the amp without changing the volume or other settings when you leave the stage, such as between sets of your live performance.

## 8 TONE SETTING

Here you can store or recall sounds that you've set up on the panel. On the KATANA-50 Mk II you can store a total of four sounds. On the KATANA-100 Mk II, KATANA-100/212 Mk II, KATANA-HEAD Mk II, or KATANA-Artist Mk II, you can store a total of eight sounds.

### KATANA-50 Mk II

BANK A	CH1, CH2
BANK B	CH1, CH2

### KATANA-100 Mk II, KATANA-100/212 Mk II, KATANA-HEAD Mk II, KATANA-Artist Mk II

BANK A	CH1, CH2, CH3, CH4
BANK B	CH1, CH2, CH3, CH4

### MEMO

50, 100/212, HEAD only

To switch between BANK A and BANK B on the KATANA-50 Mk II, KATANA-100 Mk II, or KATANA-100/212 Mk II, or KATANA-HEAD Mk II, hold down the [PANEL] button for approximately one second when any one of the [CH1]–[CH4] buttons are selected.

The selected [CH1]–[CH4] button blinks, and the bank switches between BANK A and BANK B. When BANK B is selected, the [PANEL] button blinks slowly.



\* You can't switch banks while PANEL is selected.

### [BANK] button Artist only

Switches between BANK A and BANK B.

When BANK B is selected, the [BANK] button is lit.

### [CH 1]–[CH 4] buttons

The [CH 1]–[CH 4] buttons (CH 1–CH 2 on the KATANA-50 Mk II) remember the settings of all top panel knobs (except for the [MASTER] knob) and buttons. When you press and hold a button for one second, the panel settings are stored.

\* You can make the settings back to the factory state by turning the power on while holding down the [PANEL] button.

### [PANEL] button

Makes the unit sound using the current settings of the panel knobs.

## 9 [CAB RESONANCE] switch

100/212, HEAD, Artist only

Modifies the resonance of the speaker cabinet.

Value	Explanation
VINTAGE	The warm and sweet sound of a vintage cabinet.
MODERN	A modern cabinet sound notable for a tight low-end.
DEEP	Sound with powerful low-end as well as a distinctive edge.

## 10 [POWER] switch

Turns the power of the KATANA Mk II on/off.

## 11 SOLO Artist only

### [SOLO] knob

Adjusts the volume when solo is on.

### [SOLO] button

Turns solo on/off.

## 12 TONE SHAPE Artist only

### [GLOBAL EQ] button

Turns the global equalizer on/off.

You can also switch between three types of equalizer settings (green, red, orange).

### MEMO

The three types of global equalizer settings can be edited using dedicated software (p. 10).

These settings cannot be edited from the unit itself.

### [CONTOUR] switch

Switches the contour characteristics of the sound.

In addition to "OFF," you can choose from the three types "1, 2, 3."

## Rear Panel

KATANA-50 Mk II

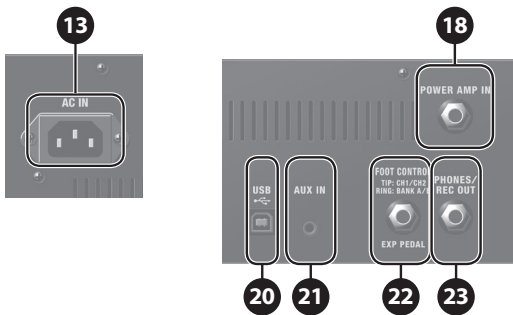

KATANA-100 Mk II, KATANA-100/212 Mk II, KATANA-HEAD Mk II

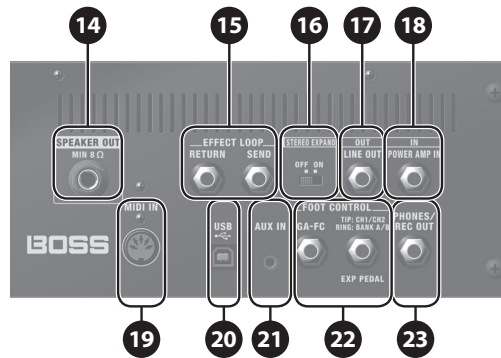

\* The illustration shows the KATANA-HEAD Mk II. KATANA-100 Mk II and KATANA-100/212 Mk II do not have MIDI jack and SPEAKER OUT jacks.

KATANA-Artist Mk II

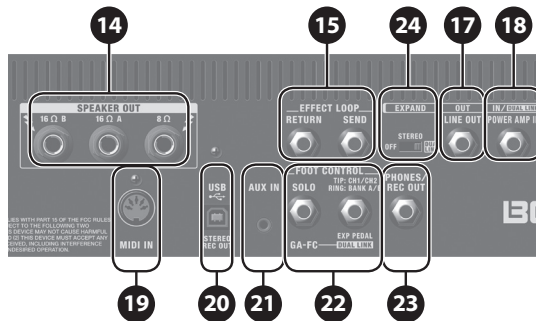

### 13 AC IN jack

Connect the included power cord.

\* Use only the power cord that was included with the unit.

### 14 SPEAKER OUT jack HEAD, Artist only

Connect a speaker box. Only use speaker cable to connect the speaker. Do not use any shielded cable designed for use with guitars.

#### When connecting an external speaker to the KATANA-HEAD Mk II

- If a plug is inserted in this jack, no sound will be output from the KATANA Mk II's own speaker.
- You must use a speaker box that has an input impedance of 8Ω or higher.



#### When connecting an external speaker to the KATANA-Artist Mk II

- When the unit is shipped from the factory, the internal speaker is connected to the 8Ω jack. If a plug is connected to the 8Ω jack, sound is not output from the 16Ω (A/B) jacks. If you want to use an external speaker, disconnect the internal speaker's plug from the 8Ω jack.
- If you use the 8Ω jack, you must use a speaker box whose input impedance is 8Ω or higher.
- If you use the 16Ω (A/B) jacks, you must use speaker boxes whose input impedance is 16Ω or higher.

### 15 EFX LOOP SEND/RETURN jacks

100, 100/212, HEAD, Artist only

Connect an external effect device (mono).

Connect the SEND jack to the input of your external effect device, and connect the output of your external effect device to the RETURN jack.

### 16 [STEREO EXPAND] switch 100, 100/212, HEAD only

Two KATANA Mk II units can be connected for stereo output.

#### Stereo connection method

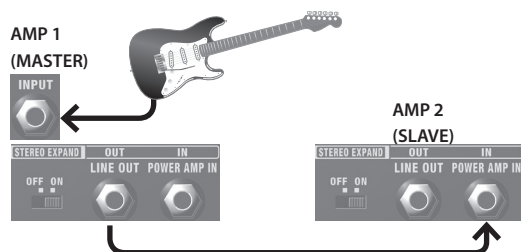

1. From the LINE OUT jack of the amp to which your guitar is connected (MASTER), connect to the POWER AMP IN jack of the other amp (SLAVE).

2. Turn "ON" the [STEREO EXPAND] switch of both amps.

\* The controls of the slave amp other than the [MASTER] knob and the [POWER CONTROL] switch do not function.

**17 LINE OUT jack** 100, 100/212, HEAD, Artist only

Connect this to your PA system or recorder. You can obtain powerful guitar amp sound just as if you were playing through the speaker.

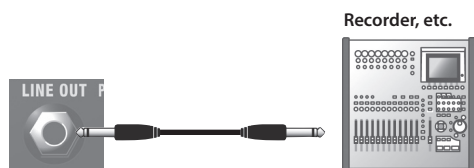

You can use this in conjunction with an external PA system, or to record your performance via direct line while monitoring the sound from the KATANA Mk II's speaker.

Adjust the output level using the [VOLUME] knob.

Since the [MASTER] knob does not affect the output, you can turn down the [MASTER] knob so that sound is output to a connected device without any sound being produced from the amp itself.

- \* To prevent malfunction and equipment failure, always turn down the volume, and turn off all the units before making any connections.

**18 POWER AMP IN jack**

This jack directly inputs a signal to the power amp without passing it through the preamp of the KATANA Mk II. You can use it to input sound that's been shaped by an external preamp or by a multi-effect unit equipped with an amp simulator. If you're using the POWER AMP IN jack, the [PANEL] button is lit green.

- \* Sound that is input to this jack is not affected by controls other than the [MASTER] knob and the [POWER CONTROL] switch.
- \* Unless you are using two KATANA Mk II units connected in stereo, leave the [STEREO EXPAND] switch or [EXPAND] switch turned "OFF."
- \* The POWER AMP IN jack and the INPUT jack cannot be used simultaneously. If cables are connected to both, the INPUT jack has priority.

**19 MIDI IN jack** HEAD, Artist only

You can control this unit from a multi-effect unit or a MIDI foot controller.

How the MIDI receive channel is specified

Receive channel	Operation
CH 1	Hold down the [CH 1] button while turning the power on.
CH 2	Hold down the [CH 2] button while turning the power on.
CH 3	Hold down the [CH 3] button while turning the power on.
CH 4	Hold down the [CH 4] button while turning the power on.

- \* Receive channel is set to CH1 when shipped from the factory.

RECOGNIZED RECEIVE DATA

RX CH			
OMNI		1-4	
		OFF (fixed)	
PC		1 (00H): BANK A CH1	
		2 (01H): BANK A CH2	
		3 (02H): BANK A CH3	
		4 (03H): BANK A CH4	
		5 (04H): PANEL	
		6 (05H): BANK B CH1	
		7 (06H): BANK B CH2	
		8 (07H): BANK B CH3	
		9 (08H): BANK B CH4	
CC	#16	BOSTER SW	
	#17	MOD SW	
	#18	FX SW	0-63: OFF, 64-127: ON
	#19	DELAY SW	
	#20	REVERB SW	
	#21	EFFECT LOOP SW	
	#80	GA-FC EXP PEDAL 1 (FX)	
	#81	GA-FC EXP PEDAL 2 (VOLUME)	0-127
	#82	EXP PEDAL	
	#83	GA-FC (FS1)	0-63: OFF, 64-127: ON
#84	GA-FC (FS1)	64-127: ON	

- \* When you operate the knobs in the EFFECTS section, the settings of the knobs become effective and the above on/off setting will be discarded.

**20 USB port**

You can use a commercially available USB 2.0 cable to record the sound of the KATANA Mk II into your computer. You can also use dedicated software to edit the settings of the internal effects (p. 10).

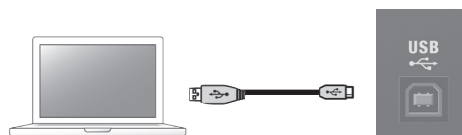

**You must install the USB driver when connecting the unit to your computer.**

Download the USB driver from the Roland website. For details, refer to Readme.htm which is included in the download.

<http://www.boss.info/support/>

**21 AUX IN jack**

Here you can connect a CD player, audio player, electronic musical instrument, or similar audio source, and listen to it while you play your guitar.

**22 FOOT CONTROL**

**SEL CH1 CH2/EXP PEDAL jack**

If you connect a footswitch (sold separately: FS-6, FS-7, or FS-5L), you can use your foot to switch between BANK A and BANK B and CH 1 and CH 2. If you connect an expression pedal (sold separately: Roland EV-5, BOSS EV-30, BOSS FV-500L, BOSS FV-500H), you can use your foot to vary the volume.

**GA-FC jack** 100, 100/212, HEAD, Artist only

You can connect the separately sold GA-FC to switch channels and turn effects on/off.

On the KATANA-Artist Mk II, you can also connect a footswitch (separately sold: FS-5L) as the SOLO jack, and use it to switch solo on/off.

**23 PHONES/REC OUT jack**

Connect headphones here. You can obtain powerful guitar sounds just as if you were playing through the speaker. To adjust the volume, use the [VOLUME] knob along with the [MASTER] knob.

- \* If a plug is inserted in this jack, no sound will be output from the KATANA Mk II's own speaker. This is convenient if you don't want loud sound to be produced from the speaker, such as when you're practicing at night.

**24 [EXPAND] switch** Artist only

You can connect two KATANA-Artist Mk II units and use them for stereo output or as dual amps.

Switch	Explanation
OFF	Use one KATANA-Artist Mk II unit by itself.
STEREO	Connect two KATANA-Artist Mk II units for stereo output. For details on connections, refer to "Stereo connection method" (p. 6).
DUAL LINK	Connect two KATANA-Artist Mk II units and use them as dual amps.

**Dual amp connections**

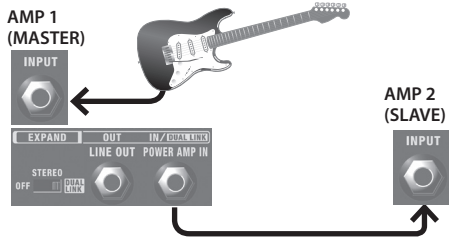

1. Connect the POWER AMP IN jack of the amp to which your guitar is connected (master) to the INPUT jack of the other amp (slave).
2. Set both amp's [EXPAND] switch to "STEREO" or "DUAL LINK."

\* Knob operations on the slave unit are disabled except for the [MASTER] knob and the [POWER CONTROL] switch.

**GA-FC connection**

If you connect the GA-FC when using a dual amp setup, you can control the two units simultaneously.

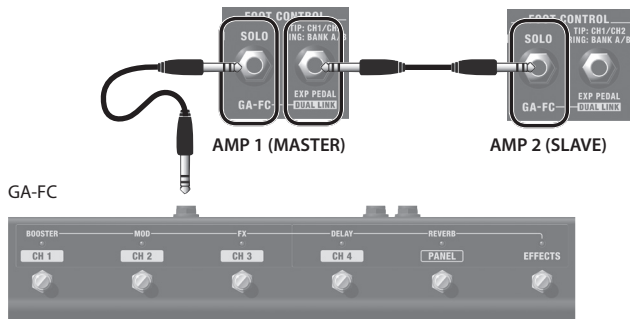

**Connecting a Footswitch**

Connecting a footswitch (sold separately: BOSS FS-6, FS-7, or FS-5L)

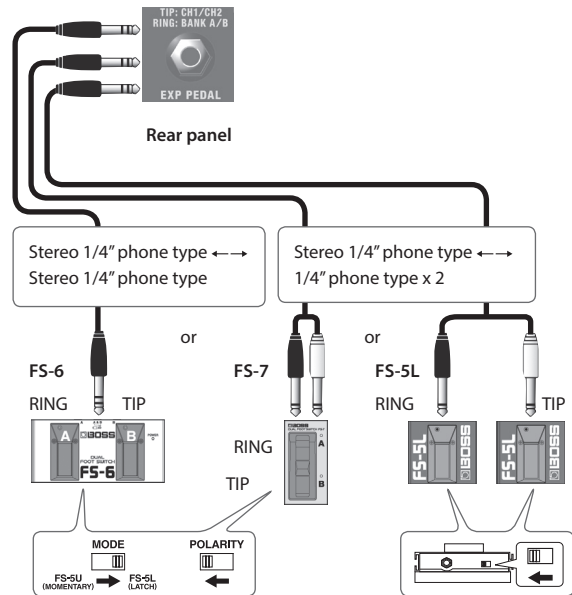

Switch	Explanation
TIP	Switches between CH1 and CH2.
RING	Switches between BANK A and BANK B.

\* The KATANA Mk II is compatible with latch-type footswitches (FS-6, FS-7, FS-5L). If you're using an FS-6 or FS-7, set the mode of A and B to FS-5L (LATCH). Momentary-type footswitches (e.g., FS-5U) cannot be used.

**Connecting the GA-FC** 100, 100/212, HEAD, Artist only

Connect a stereo cable to the GA-FC jack.

- \* Always use a stereo cable.
- \* Use cables that do not contain resistors.

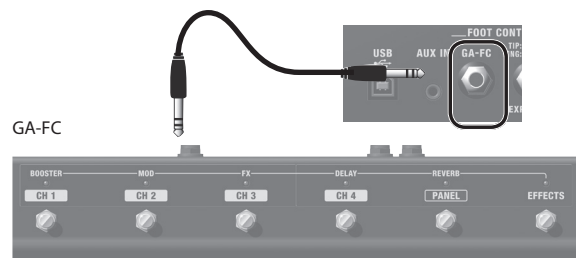

**Using the GA-FC**

You can switch TONE SELECT (CH1-CH4, PANEL). You can also switch EFFECTS (BOOSTER, MOD, FX, DELAY, REVERB) on/off.

On the KATANA-Artist Mk II, you can long-press the selected [CH1]-[CH4] or [PANEL] switch to switch solo on/off (the indicator slowly blinks green when solo is on).

If you long-press the [EFFECTS] switch (the indicator blinks), you can then use the [DELAY] switch to tap-input the delay 1 time, and use the [REVERB] switch to tap-input the delay 2 time.



### Using the expression pedals

If you connect an expression pedal (sold separately: Roland EV-5, BOSS EV-30, BOSS FV-500L, BOSS FV-500H), you can use the pedal to vary the volume or control an effect such as WAH.



Expression Pedal

Jack	Explanation
VOLUME	Adjusts the volume.
EXP	You can control an effect such as WAH.

\* You can use dedicated software (p. 10) to assign a function of your choice to an expression pedal connected to the VOLUME or EXP jack.

### Setting MINIMUM VOLUME of an expression pedal

With the [MINIMUM VOLUME] knob of an expression pedal, you can set the value for when the pedal is lifted up all the way (lowest value).

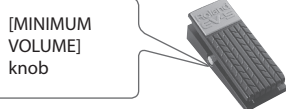

\* Use only the specified expression pedal. By connecting any other expression pedals, you risk causing malfunction and/or damage to the unit.

### Using the footswitches

If a footswitch (sold separately: FS-6, FS-7, or FS-5U) is connected, you can use it to switch between the TONE SETTING's BANK A/B, or to set the delay time (TAP).

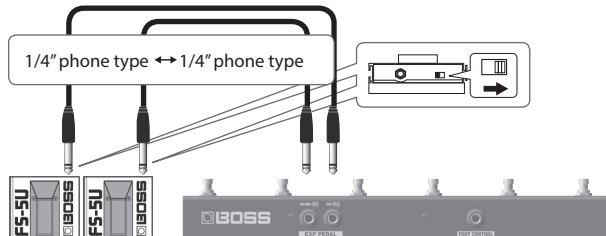

Jack	Explanation
FS1	Switches the TONE SETTING's BANK A/B.
FS2	Sets the delay time. When you press this button two or more times, the delay time is set to the interval between presses.

\* You can use dedicated software (p. 10) to assign a function of your choice to a footswitch connected to the FS1 or FS2 jack.

### Using the GA-FC to switch the BANK

With one of the channels [CH1]–[CH4] selected, hold down the [PANEL] switch for approximately one second.

The selected [CH1]–[CH4] switch blinks, and the bank switches between BANK A and BANK B. When BANK B is selected, the [PANEL] button blinks slowly.

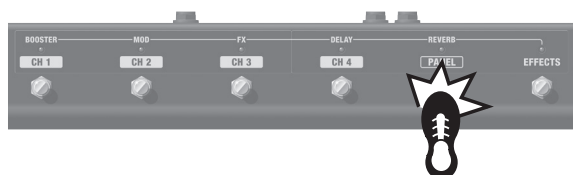

\* You can't switch banks while PANEL is selected.

## Turning the Power On/Off

\* Once everything is properly connected (p. 4–p. 7), be sure to follow the procedure below to turn on their power. If you turn on equipment in the wrong order, you risk causing malfunction or equipment failure.

**1. Make sure that the KATANA Mk II's [MASTER] knob and the volume of the devices connected to the KATANA Mk II are set to 0.**

\* Before connecting your instrument to the KATANA Mk II's INPUT jack, set the [MASTER] knob to the minimum setting (far left).

**2. Turn on the KATANA Mk II.**

\* Before turning the unit on/off, always be sure to turn the volume down. Even with the volume turned down, you might hear some sound when switching the unit on/off. However, this is normal and does not indicate a malfunction.

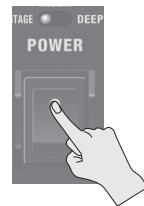

**3. Turn on the power of the devices connected to the LINE OUT jack and PHONES/REC OUT jack.**

**4. Adjust the volume levels for the devices.**

Before switching off the power, lower the volume on each of the devices in your system and then TURN OFF the devices in the reverse order to which they were switched on.

\* If you need to turn off the power completely, first turn off the unit, then unplug the power cord from the power outlet. Refer to "To completely turn off power to the unit, pull out the plug from the outlet" (p. 2).

## Restoring the Factory Settings

Here's how the settings stored in the KATANA Mk II can be returned to their factory-set condition (factory reset).

**1. While holding down the [PANEL] button, turn the power on.**

Each of the EFFECTS buttons continues blinking consecutively from the left. When the blinking stops, all of the KATANA Mk II's settings return to the factory-set state.



\* It takes approximately 30 seconds for the factory reset to be completed. Don't turn off the power while the factory reset is in progress.

# Using the Effects

On the KATANA Mk II amp, you can use five types of effect simultaneously.



## Effects assigned to each knob when the unit is shipped

Knob	Color of the button	BOOSTER	MOD
	Green	BANK A	BLUES DRIVE
		BANK B	CLEAN BOOST
	Red	BANK A	OVERDRIVE
		BANK B	MID BOOST
	Orange	BANK A	DISTORTION
		BANK B	TREBLE BOOST

Knob	Color of the button	FX	DELAY
	Green	BANK A	TREMOLO
		BANK B	PHASER 90E
	Red	BANK A	T.WAH
		BANK B	FLANGER 117E
	Orange	BANK A	HEAVY OCTAVE
		BANK B	PITCH SHIFTER

Knob	Color of the button	REVERB	
	Green	BANK A	PLATE REVERB
		BANK B	PLATE REVERB
	Red	BANK A	SPRING REVERB
		BANK B	PLATE REVERB
	Orange	BANK A	HALL REVERB
		BANK B	HALL REVERB

1. Press the [BOOSTER], [MOD], [DELAY], [FX], or [REVERB] button to select the effect that you want to use.

Each time you press the button, its color changes.



2. Turn the knob to adjust the depth of the effect.

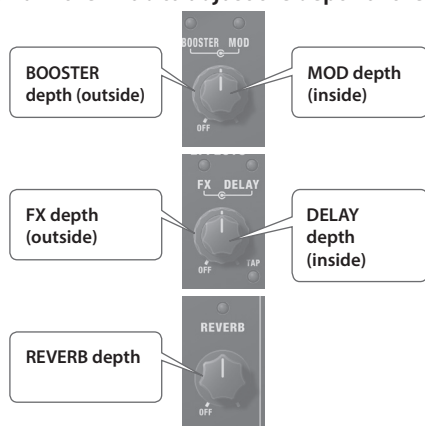

## Making use of the KATANA Mk II's dedicated software

You can connect the amp via USB to your computer, and use it with dedicated software. Using the dedicated software allows you to do the following:



- Easily download dedicated effects from Boss Tone Central (<http://bosstonecentral.com>) download site into the amp.
- Edit the effect settings.
- Back up effects and other internal settings, or restore settings from a backup.

You can easily download the dedicated software from our BOSS TONE CENTRAL (<http://bosstonecentral.com/>) website. For details on how to use the software, refer to the Readme.htm file that comes with the download.

# Block Diagram

## KATANA-50 Mk II

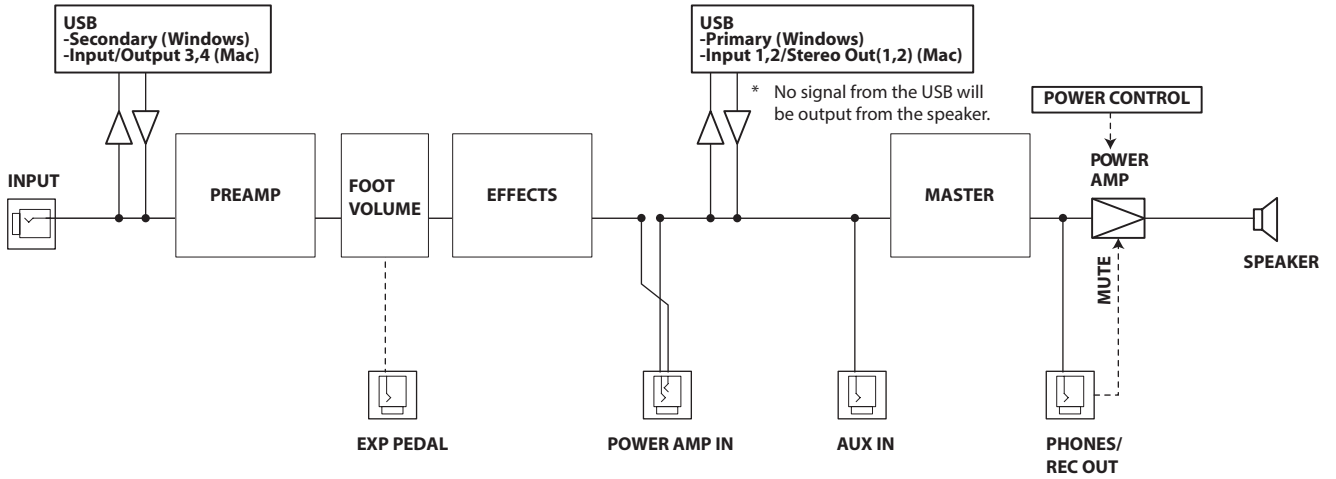

## KATANA-100 Mk II, KATANA-100/212 Mk II, KATANA-HEAD Mk II, KATANA-Artist Mk II

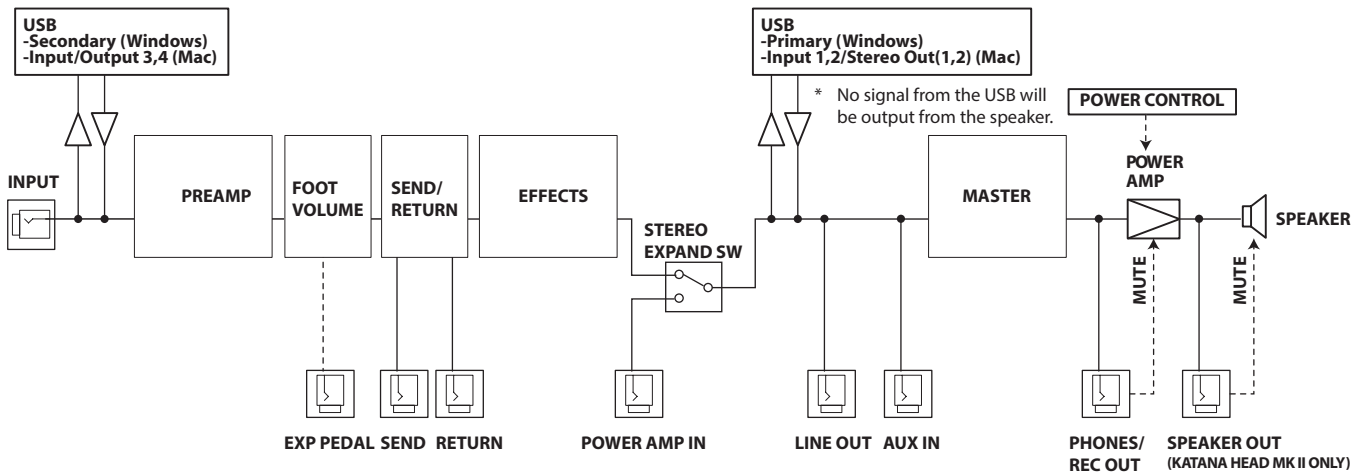

# Main Specifications

BOSS KATANA-50 Mk II: Guitar Amplifier

BOSS KATANA-100 Mk II: Guitar Amplifier

BOSS KATANA-100/212 Mk II: Guitar Amplifier

BOSS KATANA-HEAD Mk II: Guitar Amplifier

BOSS KATANA-Artist Mk II : Guitar Amplifier

	KATANA-50 Mk II	KATANA-100 Mk II	KATANA-100/212 Mk II	KATANA-HEAD Mk II	KATANA-Artist Mk II
<b>Rated Power Output</b>	50 W	100 W		30 W (Using internal speaker) 100 W (Using external speaker)	100 W
<b>Nominal Input Level</b>	INPUT: -10 dBu (1 M $\Omega$ )				
	AUX IN: -10 dBu (20 k $\Omega$ )				
		EFX LOOP RETURN: -10 dBu (100 k $\Omega$ )		EFX LOOP RETURN: -10 dBu (100 k $\Omega$ )	RETURN IN: -10 dBu (100 k $\Omega$ )
<b>Speaker</b>	30 cm (12 inches) x 1	30 cm (12 inches) x 1	30 cm (12 inches) x 2	12 cm (5 inches) x 1	30 cm (12 inches) x 1
<b>Controls</b>	[POWER] switch [MASTER] knob [POWER CONTROL] switch: STANDBY, 0.5 W, 25 W, 50 W  <AMPLIFIER> [VARIATION] button [AMP TYPE] switch: ACOUSTIC, CLEAN, CRUNCH, LEAD, BROWN [GAIN] knob [VOLUME] knob  <EQUALIZER> [BASS] knob [MIDDLE] knob [TREBLE] knob  <MULTI EFFECT> [BOOSTER] button [MOD] button [FX] button [DELAY] button [REVERB] button [TAP] button [BOOSTER] knob [MOD] knob [FX] knob [DELAY] knob [REVERB] knob  <TONE SETTING> [CH1] button [CH2] button [PANEL] button	[POWER] switch [MASTER] knob [PRESENCE] knob [POWER CONTROL] switch: STANDBY, 0.5 W, 50 W, 100 W  <AMPLIFIER> [VARIATION] button [AMP TYPE] knob: ACOUSTIC, CLEAN, CRUNCH, LEAD, BROWN [GAIN] knob [VOLUME] knob  <EQUALIZER> [BASS] knob [MIDDLE] knob [TREBLE] knob  <MULTI EFFECT> [BOOSTER] button [MOD] button [FX] button [DELAY] button [REVERB] button [TAP] button [BOOSTER] knob [MOD] knob [FX] knob [DELAY] knob [REVERB] knob  <TONE SETTING> [CH1] button [CH2] button [CH3] button [CH4] button [PANEL] button  <STEREO EXPAND> STEREO EXPAND switch	[POWER] switch [MASTER] knob [PRESENCE] knob [POWER CONTROL] switch: STANDBY, 0.5 W, 50 W, 100 W [CAB RESONANCE] switch: VINTAGE, MODERN, DEEP  <AMPLIFIER> [VARIATION] button [AMP TYPE] knob: ACOUSTIC, CLEAN, CRUNCH, LEAD, BROWN [GAIN] knob [VOLUME] knob  <EQUALIZER> [BASS] knob [MIDDLE] knob [TREBLE] knob  <MULTI EFFECT> [BOOSTER] button [MOD] button [FX] button [DELAY] button [REVERB] button [TAP] button [BOOSTER] knob [MOD] knob [FX] knob [DELAY] knob [REVERB] knob  <TONE SETTING> [CH1] button [CH2] button [CH3] button [CH4] button [PANEL] button  <STEREO EXPAND> STEREO EXPAND switch	[POWER] switch [MASTER] knob [PRESENCE] knob [SOLO] knob [GLOBAL EQ] button [CONTOUR] switch: OFF, 1, 2, 3 [POWER CONTROL] switch: STANDBY, 0.5 W, 50 W, 100 W [CABINET RESONANCE] switch: VINTAGE, MODERN, DEEP  <AMPLIFIER> [VARIATION] button [AMP TYPE] knob: ACOUSTIC, CLEAN, CRUNCH, LEAD, BROWN [GAIN] knob [VOLUME] knob  <EQUALIZER> [BASS] knob [MIDDLE] knob [TREBLE] knob  <MULTI EFFECT> [BOOSTER] button [MOD] button [FX] button [DELAY] button [REVERB] button [TAP] button [BOOSTER] knob [MOD] knob [FX] knob [DELAY] knob [REVERB] knob  <TONE SETTING> [BANK] button [CH1] button [CH2] button [CH3] button [CH4] button [PANEL] button  <EXPAND> EXPAND switch: OFF, STEREO, DUAL LINK	

	KATANA-50 Mk II	KATANA-100 Mk II	KATANA-100/212 Mk II	KATANA-HEAD Mk II	KATANA-Artist Mk II
<b>Indicators</b>	VARIATION BOOSTER MOD FX DELAY REVERB TAP CH1 CH2 PANEL	VARIATION ACOUSTIC CLEAN CRUNCH LEAD BROWN BOOSTER MOD FX DELAY REVERB TAP CH1 CH2 CH3 CH4 PANEL			ACOUSTIC CLEAN CRUNCH LEAD BROWN VARIATION BOOSTER MOD FX DELAY REVERB TAP BANK CH1 CH2 CH3 CH4 PANEL GLOBAL EQ
<b>Connectors</b>	INPUT jack: 1/4-inch phone type POWER AMP IN jack: 1/4-inch phone type REC OUT/PHONES jack: Stereo 1/4-inch phone type EXP PEDAL/CTL CH1/CH2 jack: 1/4-inch TRS phone type AUX IN jack: Stereo miniature phone type USB port: USB B type AC IN jack	INPUT jack: 1/4-inch phone type POWER AMP IN jack: 1/4-inch phone type LINE OUT jack: 1/4-inch phone type SEND jack: 1/4-inch phone type RETURN jack: 1/4-inch phone type REC OUT/PHONES jack: Stereo 1/4-inch phone type EXP PEDAL/CTL CH1/CH2 jack: 1/4-inch TRS phone type GA-FC jack: 1/4-inch TRS phone type AUX IN jack: Stereo miniature phone type USB port: USB B type AC IN jack		INPUT jack: 1/4-inch phone type POWER AMP IN jack: 1/4-inch phone type LINE OUT jack: 1/4-inch phone type SEND jack: 1/4-inch phone type RETURN jack: 1/4-inch phone type SPEAKER OUT jack: 1/4-inch phone type REC OUT/PHONES jack: Stereo 1/4-inch phone type EXP PEDAL/CTL CH1/CH2 jack: 1/4-inch TRS phone type GA-FC jack: 1/4-inch TRS phone type AUX IN jack: Stereo miniature phone type USB port: USB B type MIDI IN connector AC IN jack	INPUT jack: 1/4-inch phone type POWER AMP IN/DUAL LINK jack: 1/4-inch phone type LINE OUT jack: 1/4-inch phone type SEND jack: 1/4-inch phone type RETURN jack: 1/4-inch phone type SPEAKER OUT 16 ohms A jack: 1/4-inch phone type SPEAKER OUT 16 ohms B jack: 1/4-inch phone type SPEAKER OUT 8 ohms jack: 1/4-inch phone type REC OUT/PHONES jack: Stereo 1/4-inch phone type EXP PEDAL/CTL CH1/CH2 jack: 1/4-inch TRS phone type GA-FC/CTL SOLO jack: 1/4-inch TRS phone type AUX IN jack: Stereo miniature phone type USB port: USB B type MIDI IN connector AC IN jack
<b>Power Consumption</b>	47 W	77 W			
<b>Dimensions</b>	470 (W) x 238 (D) x 398 (H) mm 18-9/16 (W) x 9-3/8 (D) x 15-11/16 (H) inches	530 (W) x 248 (D) x 484 (H) mm 20-7/8 (W) x 9-13/16 (D) x 17-1/2 (H) inches	670 (W) x 248 (D) x 484 (H) mm 26-7/16 (W) x 9-13/16 (D) x 19-1/16 (H) inches	470 (W) x 228 (D) x 215 (H) mm 18-9/16 (W) x 9 (D) x 8-1/2 (H) inches	630 (W) x 248 (D) x 515 (H) mm 24-13/16 (W) x 9-13/16 (D) x 20-5/16 (H) inches
<b>Weight</b>	11.6 kg 25 lbs 10 oz	14.8 kg 32 lbs 11 oz	19.8 kg 43 lbs 11 oz	8.8 kg 19 lbs 7 oz	19 kg 41 lbs 15 oz
<b>Accessories</b>	Owner's Manual Power cord	Owner's Manual Power cord GA-FC sticker			
<b>Options (sold separately)</b>	Footswitch: BOSS FS-5L Expression pedal: Roland EV-5, BOSS EV-30, BOSS FV-500L, BOSS FV-500H	Footswitch: BOSS FS-5L, BOSS FS-6, BOSS FS-7 Expression pedal: Roland EV-5, BOSS EV-30, BOSS FV-500L, BOSS FV-500H GA FOOT CONTROLLER (GA-FC)			

\* 0 dBu = 0.775 Vrms

\* This document explains the specifications of the product at the time that the document was issued. For the latest information, refer to the Roland website.

English

日本語

Deutsch

Français

Italiano

Español

Português

Nederlands

 **BOSS**