

# Digital Drum

## Owner's Manual

# INFORMATION FOR YOUR SAFETY!

## THE FCC REGULATION WARNING (for USA)

This equipment has been tested and found to comply with the limits for a Class B digital device, pursuant to Part 15 of the FCC Rules.

These limits are designed to provide reasonable protection against harmful interference in a residential installation. This equipment generates, uses, and can radiate radio frequency energy and, if not installed and used in accordance with the instructions, may cause harmful interference to radio communications. However, there is no guarantee that interference will not occur in a particular installation.

If this equipment does cause harmful interference to radio or television reception, which can be determined by turning the equipment off and on, the user is encouraged to try to correct the interference by one or more of the following measures:

- Reorient or relocate the receiving antenna.
- Increase the separation between the equipment and receiver.
- Connect the equipment into an outlet on a circuit different from that to which the receiver is connected.
- Consult the dealer or an experienced radio/TV technician for help.

Unauthorized changes or modification to this system can void the user's authority to operate this equipment.

### CAUTION

The normal function of the product may be disturbed by Strong Electro Magnetic Interference. If so, simply reset the product to resume normal operation by following the owner's manual. In case the function could not resume, please use the product in other location.

## PRECAUTIONS

### PLEASE READ CAREFULLY BEFORE PROCEEDING

Please keep this manual in a safe place for future reference.

#### Power Supply

Please connect the designated AC adaptor to an AC outlet of the correct voltage.

Do not connect it to an AC outlet of voltage other than that for which your instrument is intended.

Unplug the AC power adaptor when not using the instrument, or during electrical storms.

#### Connections

Before connecting the instrument to other devices, turn off the power to all units. This will help prevent malfunction and / or damage to other devices.

#### Location

Do not expose the instrument to the following conditions to avoid deformation, discoloration, or more serious damage:

- Direct sunlight
- Extreme temperature or humidity
- Excessive dusty or dirty location
- Strong vibrations or shocks
- Close to magnetic fields

#### Interference with other electrical devices

Radios and televisions placed nearby may experience reception interference. Operate this unit at a suitable distance from radios and televisions.

#### Cleaning

Clean only with a soft, dry cloth. Do not use paint thinners, solvents, cleaning fluids, or chemical-impregnated wiping cloths.

#### Handling

Do not apply excessive force to the switches or controls.

Do not let paper, metallic, or other objects into the instrument. If this happens, remove the electric plug from the outlet. Then have the instrument inspected by qualified service personnel.

Disconnect all cables before moving the instrument.

# Contents

<b>Main Features</b> .....	4	<b>Recording</b>	
<b>Panel &amp; Display Description</b>		MIDI Recording and MP3 Recording.....	17
Front Panel.....	5	Prepare and Start Recording.....	17
Rear Panel.....	6	Rename and Save MIDI Recording.....	18
LCD Display.....	6		
<b>Setup</b>		<b>Coach</b>	
Connecting the Pads and Pedals.....	7	Quiet Count.....	19
<b>Getting Ready to Play</b>		Beat Check.....	20
Setting up the Power Supply.....	8	Change Up.....	20
Turning on the Power.....	8	<b>USB Memory</b>	
Turning off the power.....	8	Song Folder.....	22
Restore Factory Settings.....	8	Load Voice.....	22
<b>Quick Play</b>		Format USB Memory.....	23
Drum Kits and Voices.....	9	<b>Volume Sliders</b> .....	24
Selecting a Drum Kit.....	9	<b>Settings</b>	
Selecting a Voice.....	9	Trigger Settings.....	25
Playing Techniques.....	9	Master Compress.....	26
<b>Drum Kit</b>		MIDI Setup.....	27
Preset, User and iKit Drum Kits.....	11	Auto Power Off.....	27
Selecting a Drum Kit.....	11	Factory Reset.....	28
Editing Kit Parameters.....	12	<b>Specifications</b> .....	29
Editing Kit Effect.....	12	<b>Appendices</b>	
REVERB.....	13	Drum Kit List.....	30
EQ.....	14	iKit List.....	30
Saving a User Kit.....	14	Drum Voice List.....	31
<b>Click</b>		Song List.....	36
Turning the Click on or off.....	15	GM Drum Kit List.....	37
Editing Click Parameters.....	15	GM Melody Voice List.....	39
<b>Song</b>		MIDI Implementation Chart.....	40
Playing Preset Songs.....	16	Prompt Messages.....	41
Playing USB Songs.....	16		
Playing Along with a Song.....	17		

# Main Features



## PURE DRUM Technology

No matter playing the pads with soft stroke or forceful passion grooves, with this new technology, all performances can show up extremely wide range of velocity dynamics. Perfectly express the various changes of acoustic drums, all of these let you enjoy the real delicate nuances, capture the unique characteristics of acoustic drum kit from the PURE DRUM!

## PURE DRUM - Bringing Natural and Realistic Voices to Your Performance!

This unique PURE DRUM technology greatly improves sound quality for digital drums, bringing a more natural and realistic feel to your ears. No matter playing stroke roll or striking pads with velocity dynamics, all these will let you enjoy the delicate nuances and natural voice, capture the unique characteristics of acoustic drum kit.

## iKit – Playing with Super Delicate Sensitivity

This black technology makes digital drums reach a new height. The improved dynamics and sensitivity replicates every nuance of an acoustic drum and gives you a more natural feel of any subtle change in velocity dynamics.

## Playing and Recording along with Song Playback

You can freely play the digital drum while playing back songs (MIDI, WAV and MP3 format) stored on a USB flash drive. Or play along with background music transmitted from AUX IN, and record your performance in real time and save it to a USB flash drive.

## Downloading Your Favorite Voices to the Module

By using the USB flash drive function, you can transmit your favorite wave samples (achieved from the internet or sound source software) to the module and use them as internal voices, giving your drum voices unlimited possibility. Try and experience this exciting feature.

# Panel & Display Description

## Front Panel

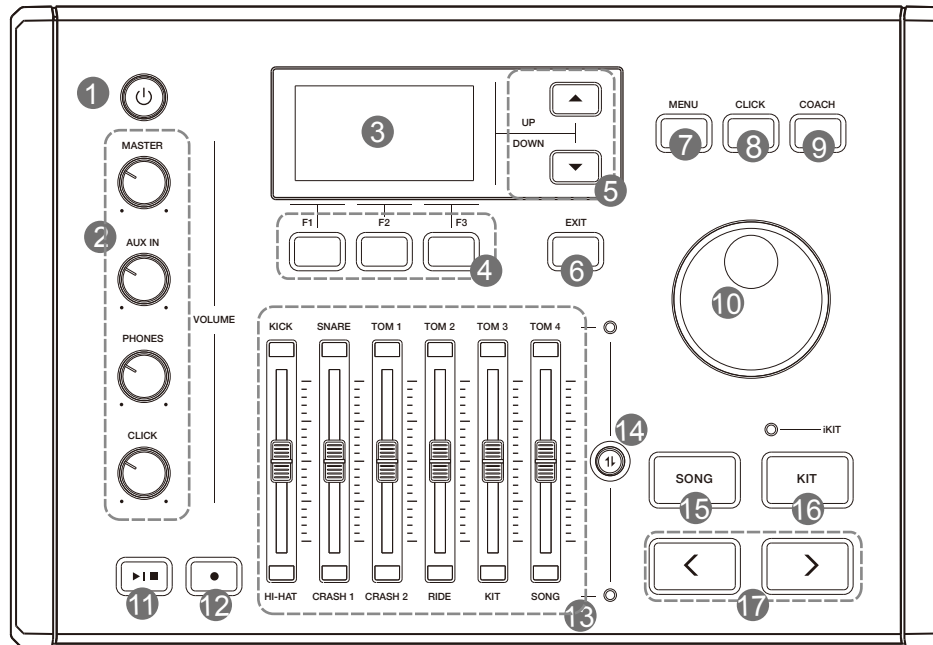

### 1. [POWER] Button

Turn the power on or off.

### 2. [MASTER] Knob

Adjust the output volume.

### [AUX IN] Knob

Adjust the audio input volume.

### [PHONES] Knob

Adjust the phones volume.

### [CLICK] Knob

Adjust the click volume.

### 3. LCD Display

Display the name and parameter settings of Kits, Voices and Songs etc.

### 4. [F1] ~ [F3] Buttons

Press to execute a related function shown on LCD.

### 5. [^]/[v] Buttons

Press to move the cursor to select a parameter on LCD.

### 6. [EXIT] Button

Press to return to previous menu.

### 7. [MENU] Button

**In kit mode:** press to enter KIT menu.

**In song mode:** press to enter SONG menu.

### 8. [CLICK] Button

Press to start/stop the click; edit the click setting.

### 9. [COACH] Button

Press to enter coach mode.

### 10. Data Dial

Rotate to adjust the selected parameter.

### 11. [▶|■] Button

Press to start/stop playing a song.

### 12. [•] Button

Press to enter record mode.

### 13. Volume Sliders

Adjust the related trigger volume, kit volume and song volume.

### 14. Volume Slider Control Button

Press to toggle between the upper and lower group of parameters.

### 15. [SONG] Button

Press to enter song mode.

### 16. [KIT] Button

Press to enter kit mode.

### 17. [<]/[>] Buttons

Press to select a drum kit or edit parameters (to increase/decrease the value).

# Panel & Display Description

## Rear Panel

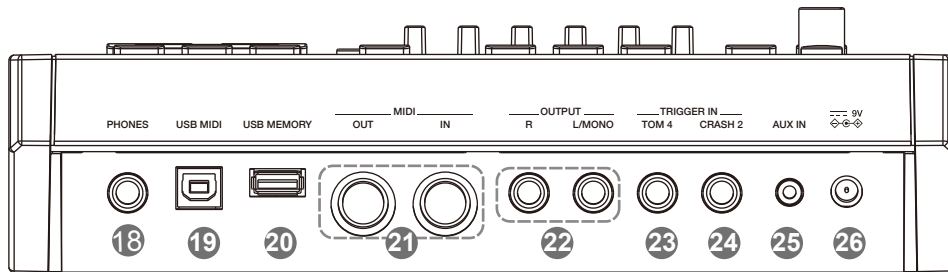

**18. PHONES jack (1/4")**

Connect a pair of stereo headphones to detect all output sounds.

**19. USB MIDI jack**

Connect to PC and transmit MIDI data.

**20. USB MEMORY jack**

Connect a USB flash drive. You can play back songs stored on the flash drive or transmit wave files to the module.

**21. MIDI jacks (IN, OUT/THRU)**

Connect an external MIDI sequencer to receive or transmit MIDI data.

**22. OUTPUT jacks (L/MONO, R)(2 x1/4")**

Connect to an audio system or amplifier. Use the L/MONO and R jacks for stereo output or just the L/MONO jack for mono output.

**23. TOM 4 jack (1/4")**

Connect an additional Tom 4.

**24. CRASH 2 jack (1/4")**

Connect an additional Crash 2.

**25. AUX IN jack (1/8")**

Connect an external audio player, such as an MP3. Music from the external player will be transmitted to the module, and you can play along.

**26. DC IN jack**

Connect the specified power adaptor.

**27. TRIGGER INPUT jack**

Insert the dedicated trigger cables here, to connect the pads and pedals.

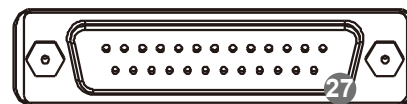

## LCD Display

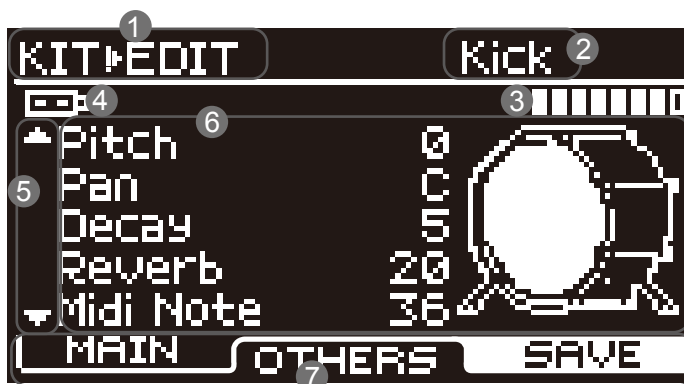

**1. Menu**

Display the current menu, such as "KIT", "SONG" and "COACH" etc.

**2. Trigger Pad Name**

Display the selected trigger pad name, such as "Kick", "Snare Head" and "Snare Rim" etc.

**3. Velocity of Pad Strike**

Display the velocity (force) at which the pad is struck.

**4. External Device**

Indicate a USB flash drive is correctly connected.

**5. Prompt to Move Cursor Up/Down**

Prompt to press the [^]/[v] buttons to view more parameters.

**6. Detailed Parameters**

Display detailed parameter settings.

**7. [F1]/[F2]/[F3] Indicators**

Display functions of the [F1] ~ [F3] buttons.

**Caution!**

To prevent electric shock and damage to the device, make sure the power is switched OFF on the drum and all related device before making any connection.

**Connecting the Pads and the Pedals****Standard configuration:**

KICK, SNARE (dual-zone trigger), TOM 1~3 (dual-zone trigger), CRASH (dual-zone trigger with choke), RIDE (triple-zone trigger with choke), HI-HAT (dual-zone trigger), PEDAL(HI-HAT).

**Note:**

1. Use the cables provided to connect the pads to the trigger input jack on the rear panel of the module, make sure each pad is connected to its corresponding trigger input jack.
2. For details on assembling the drum stand, attaching the digital drum and connecting the pads, please refer to the **Setup manual**.

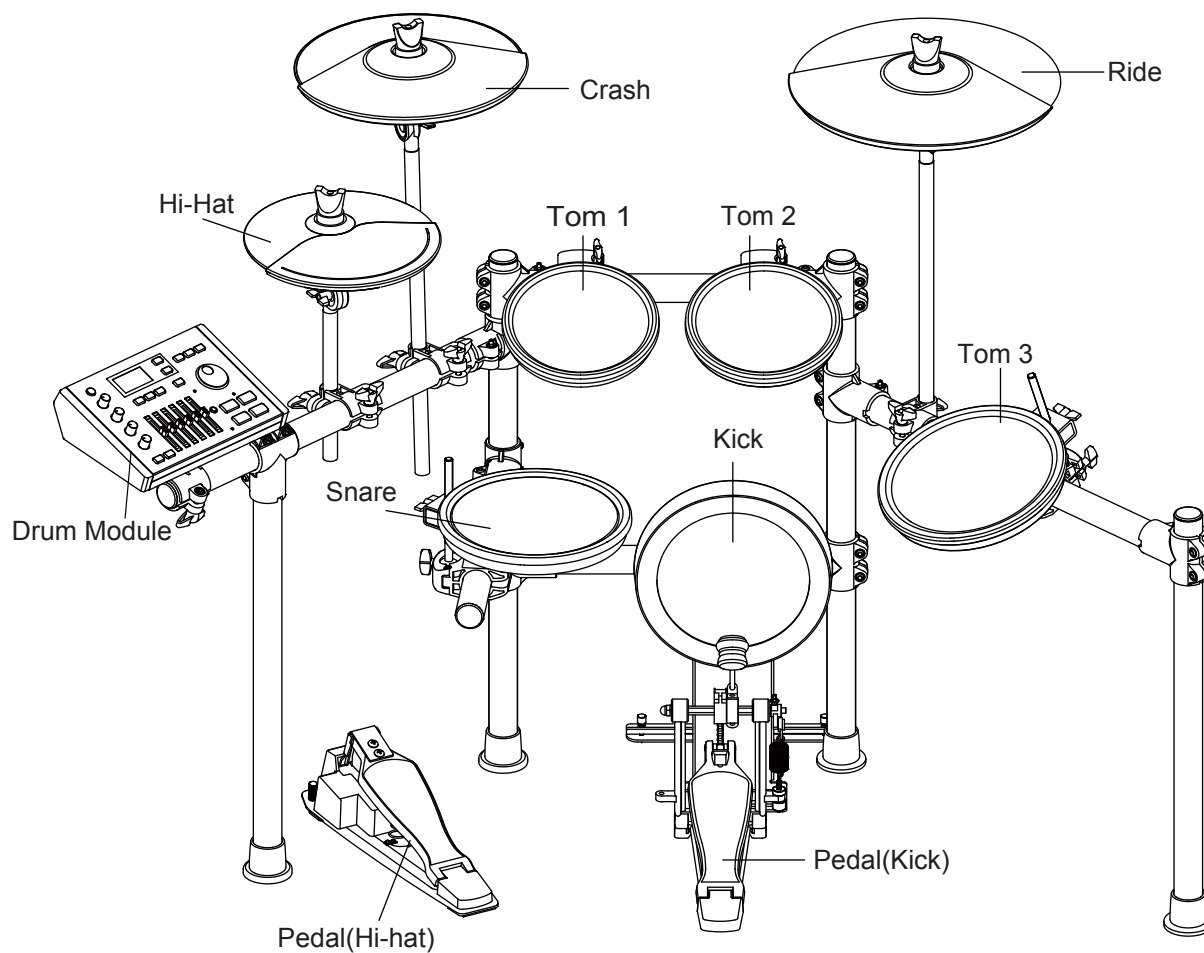

# Getting Ready to Play

## Setting up the Power Supply

1. Connect the power adaptor to the DC IN jack on the rear panel.
2. Plug the other end of the power cord to an appropriate AC outlet.

### Note:

1. Please use the specified power adaptor.
2. Even when the module is turned off, electricity is still flowing to the module at minimum level. Please unplug the module when it is not in use for a long time.

## Turning on the Power

Make sure you have completed all necessary connections (triggers, audio device and so on). Then turn the volume level of all the devices to minimum.

1. Turn all the volume knobs to minimum before turning on the power.
2. Press the [POWER] button, the display is lit, indicating the module is turned on.
3. Turn on the connected amplifier or audio device, or listen with headphones.
4. Adjust the [MASTER]/[PHONES] knobs clockwise while striking the pads, until you get an appropriate volume level.



## Turning off the power

1. Turn the volume level of the module and the connected audio device to minimum.
2. Turn off the connected device.
3. Press the [POWER] button until the display becomes unlit.

### Auto Power Off

In order to save energy, the module will automatically shut down after 30 minutes if it is not in use (playing, striking, button pressing, etc.) You can enable or disable this function as desired. Please refer to **Option**.

## Restore Factory Settings

Follow the operation below to reset the module to factory settings.

1. Press and hold [<] and [>] buttons, then press the [POWER] button to turn on the power.
2. The LCD will display "Factory Resetting...". When factory reset is finished, the display will return to KIT menu.  
The following parameters will restore factory settings: Trigger, MIDI Setup, Option, Master Compress, User Kits and User Songs.

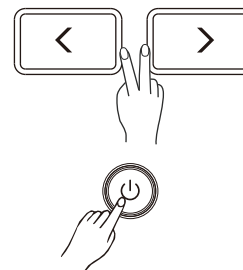



# Quick Play

## Drum Kits and Voices

A drum kit is the voices combination of all pads and cymbals. An acoustic drum has only one fixed kit and it's unchangeable. However, a digital drum is preset with various voices of different styles and some characterized voices of similar styles, allowing you to combine different voices and make as many drum kits as you like. (Please refer to **Drum Kit List** and **Drum Voice List**)

## Selecting a Drum Kit

1. Press the [KIT] button to enter KIT menu. The "KIT" indicator appears on LCD.
2. Press the [^]/[v] buttons to select an item to edit. Then use the data dial or [<]/[>] buttons to select a desired drum kit and adjust the kit volume.

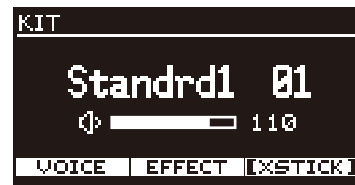

## Selecting a Voice

Strike the pads and enjoy the ensemble sound effect. You can also change the voice setting for each pad as desired.

1. Press the [KIT] button to enter KIT menu. Then press the [F1 (VOICE)] button to enter VOICE menu.
2. Strike the pad that you want to edit. The LCD will display the pad name.
3. Press the [^]/[v] buttons to select an item to edit. Then use the data dial or [<]/[>] buttons to select a desired voice and adjust relevant settings.



## Playing Techniques

This section introduces various performing techniques to make your performance more professional. Similar to an acoustic drum kit, the digital drum responds differently to various playing techniques and dynamics. All the pads are velocity sensitive. And some voices change timbre depending on the striking force.

### Pad

The snare drum can detect head shot, rim shot and cross stick. The tom drum pad can respond head and rim shot.

### Head Shot

Strike only the head of the pad.

### Rim Shot

Strike the head and the rim of the pad simultaneously. Or strike only the rim of the pad.

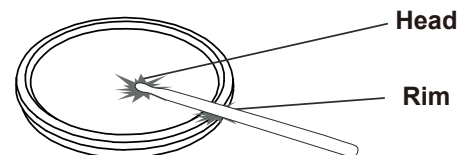
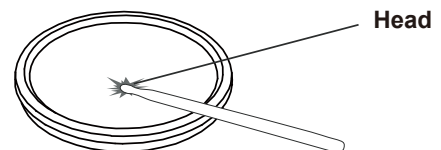

## Quick Play

### Cross Stick (X Stick)

When X-STICK is in use, strike the snare rim slightly and it will respond X-STICK effect. However, if you strike the snare rim with force, it will respond Rim Shot.

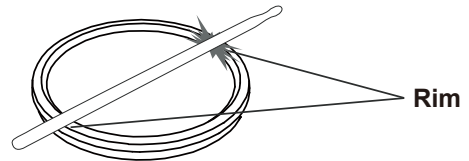

### Cymbal

#### Cymbal Bow Shot

Strike the middle area of the cymbal.

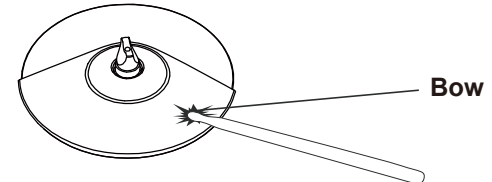

#### Cymbal Edge Shot

Strike the edge area of the cymbal.

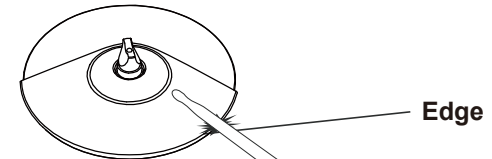

#### Cymbal Bell Shot

Strike the Ride bell area of the cymbal.

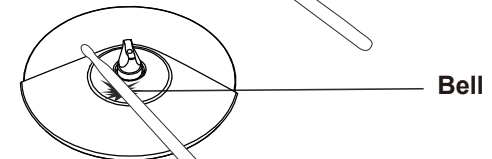

### Choke Play

Both Ride and Crash cymbals have cymbal choke.

Choking the crash/ride edge with the hand immediately after hitting the crash/ride will mute the crash/ride sound.

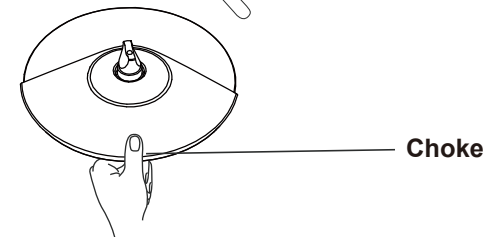

### Hi-Hat

#### Hi-Hat Pedal Change

Press down the pedal to different positions, the pad voice will change along when striking the Hi-Hat pad. This is similar to an acoustic drum.

#### Open Hi-Hat

Strike the Hi-Hat pad without pressing the pedal.

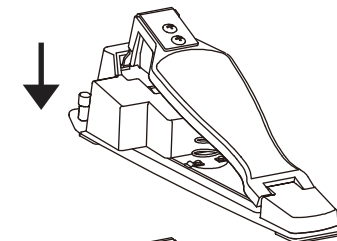

#### Closed Hi-Hat

Strike the Hi-Hat pad with the pedal pressed completely down.

#### Hi-Hat Pedal

Press down the hi-hat control pedal to create a foot-close sound without having to strike the hi-hat pad.

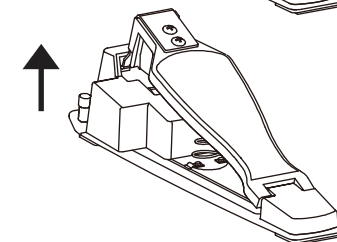

#### Splash

Play the hi-hat with the pedal fully pressed and then instantly releasing it.

# Drum Kit

## Preset, User and iKit Drum Kits

**Preset drum kit:** kits that are preset on the module. Changes of kit parameters cannot be saved to a preset drum kit.

**User drum kit:** kits parameters are changeable and can be saved on the module.

**iKit drum kit:** unique kits of this digital drum. The iKit feature will dramatically enhance the sensitivity of the snare when you play with low velocity.

The module provides 99 drum kits, including 50 preset drum kits (no.1~50), 49 user drum kits (no. 51~99). In addition, there are 5 individual iKit drum kits for iKit feature.

### Notes:

1. In iKit mode, it affects only the sensitivity of the snare when you play with low velocity. You can play the other triggers as in a normal drum kit.
2. In iKit mode, these parameters of snare head are not changeable: voice, pitch and decay etc. But you can adjust the other parameters as desired.
3. In iKit mode, the Trigger menu is not available. Trigger parameters are not editable.
4. In iKit mode, it requires proper grounding when connecting devices to the AUXIN and OUTPUT jacks.

You can edit the parameters of a drum kit, and then save it to a user drum kit. Please refer to **Drum Kit List** for details.

### The structure of a drum kit:

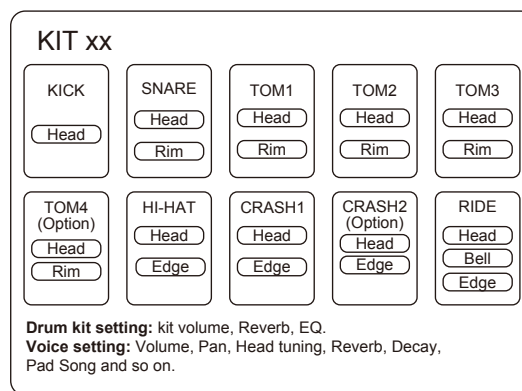

## Selecting a Drum Kit

1. Press the [KIT] button to enter KIT menu. The LCD displays the current kit number and kit volume. Press the [KIT] button again to enter iKIT menu. Pressing the [KIT] button will toggle between KIT menu and iKIT menu.
2. In KIT/iKIT menu, use the [<]/[>] buttons or the data dial to select a desired drum kit.
3. In KIT/iKIT menu, press the [V] button to select the volume item, then use the [<]/[>] buttons or the data dial to adjust the volume.

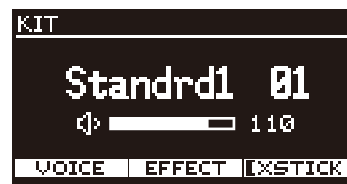

Functions of [F1]~[F3] buttons in KIT/iKIT menu:

Button	Parameter on LCD	Parameter Name	Description
[F1]	VOICE	Voices in current kit	Edit voice parameters.
[F2]	EFFECT	Drum kit effect	Edit drum kit effects, only for kit mode
[F3]	XSTICK	Cross stick	Switch cross stick on or off.

After entering the relevant sub-menu, use the [^]/[v] buttons to select a parameter to edit, then use the data dial or [<]/[>] buttons to adjust the settings.

# Drum Kit

## Edit the Kit Parameters

1. Press the [KIT] button to enter KIT menu, then press the [F1(VOICE)] to enter VOICE menu.
2. When editing voice and effect parameters, save it to a user kit after editing, otherwise, the edited data will be lost when you select a different drum kit or power off the module.

Functions of [F1]~[F3] buttons in KIT-VOICE menu :

Button	Parameter on LCD	Parameter Name	Description
[F1]	MAIN	Main parameters in voice menu	Edit important and frequently used parameters.
[F2]	OTHERS	Common parameters in voice menu	Edit other parameters of voice.
[F3]	SAVE	Save kit	Save the settings to a user kit.

## Editing Main Parameters

1. Press the [KIT] button, then press [F1 (VOICE)] to enter VOICE menu.
2. Select a trigger pad.  
Strike the pad that you want to edit. The LCD will display the selected pad name.  
You can also use the [^]/[v] buttons to select the pad item, then use the data dial or [<]/[>] buttons to select a pad name.
3. Select a voice.  
Press the [^]/[v] buttons to select the voice item, then use the data dial or [<]/[>] buttons to select a desired voice.
4. Adjust the volume.  
Press the [^]/[v] buttons to select the volume item, then use the data dial or [<]/[>] buttons to adjust the volume.

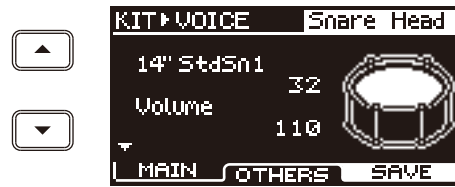

5. Parameters and their range:

Voice Parameter	Description	Range
Number	Select a voice.	1~650
Volume	Adjust the voice volume.	0~127

### Notes:

1. For voice details, please refer to the **Drum Voice List**.
2. The indicator “▼” on LCD means you can use the [v] button to move the cursor downwards to select a parameter. In the same way, the indicator “▲” on LCD suggests that you can use the [^] button to move the cursor upwards to select a parameter.

## Editing Other Parameters

1. Press the [KIT] button, then press [F1 (VOICE)], and then press [F2 (OTHERS)] to enter KIT-EDIT menu.
2. Select a trigger pad.  
Strike the pad that you want to edit. The LCD will display the selected pad name.  
You can also use the [^]/[v] buttons to select the pad item, then use the data dial or [<]/[>] buttons to select a pad name.
3. Select a parameter to edit.  
Press the [^]/[v] buttons to select a parameter, then use the data dial or [<]/[>] buttons to change the setting.

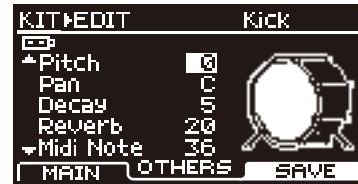
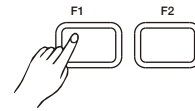

### 4. Parameters and their range:

Voice Parameter	Description	Range
Pitch	Pitch.	-8~+8
Pan	Pan	L8~C~R8
Decay	Decay	0~5
Reverb	Reverb level	0~127
Midi Note	MIDI notes transmitted from MIDI OUT.	0~127
Pad Ptn	Select a song for pad pattern; the selected song will play back when you hit the pad. Selecting "OFF" will disable this function.	OFF, 1~100
Min Velocity	Set the minimum velocity. When the pad is struck at a smaller velocity, it will respond the minimum velocity. A high values will produce a loud sound even if the pad is hit softly.	1~127
Strainer	Switch the strainer effect on or off. Only for snare pad voices that contain strainer effect.	--, OFF, ON

## Editing Kit Effect

1. Press the [KIT] button, then press [F2 (EFFECT)] to enter EFFECT menu.
2. The EFFECT menu contains two effects: REVERB and EQ. Use the [F1]/[F2] buttons to select.

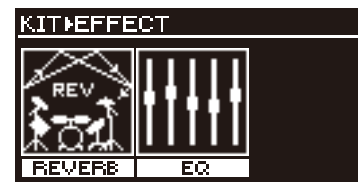
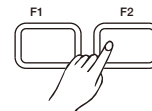

### REVERB

1. Press the [KIT] button, then press [F2 (EFFECT)], and then press [F1 (REVERB)] to enter REVERB menu.
2. Press the [^]/[v] buttons or [F1]/[F2] buttons to select a parameter, then use the data dial or [<]/[>] buttons to change the setting.



### 3. Parameters and their range:

Reverb Parameter	Description	Range
Type	Reverb type	Room1, Room2, Room3, Hall1, Hall2, Church, Delay, Pan Delay
Level	Reverb level	0~127
Time	Reverb time for Room1, Room2, Room3, Hall1, Hall2, Church	0.30~12.00s
	Reverb time for Delay and Pan Delay	0~325ms

# Drum Kit

## EQ

1. Press the [KIT] button, then press [F2 (EFFECT)], and then press [F2 (EQ)] to enter EQ menu.
2. Press the [^]/[v] buttons or [F1]/[F2] buttons to select a parameter, then use the data dial or [<]/[>] buttons to change the setting.
3. Parameters and their range:

EQ Parameter	Description	Range
Low Freq	Low-band frequency cutoff	50~20000Hz
Low Gain	Low-band frequency gain	-12 dB~+12dB
Mid Freq	Mid-band frequency	50~20000Hz
Mid Gain	Mid-band frequency gain	-12 dB~+12dB
Mid Q	Mid-band frequency Q value	0.00~12.00
High Freq	High-band frequency cutoff	50~20000Hz
HighGain	High-band frequency gain	-12 dB~+12dB

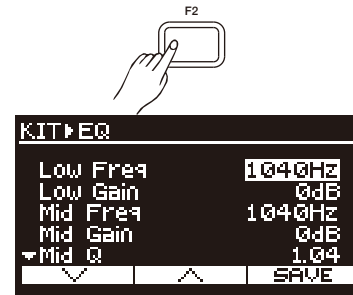

## Saving a User Kit

1. Press the [KIT] button, then press [F1 (VOICE)] to enter VOICE menu.
2. Select and edit voice-related parameters, such as voice parameters, reverb and EQ etc.
3. After editing, press [F3 (SAVE)] to enter SAVE menu.
4. Press the [^]/[v] buttons to select a user kit where the edited data will be saved.  
**Note:** If you press [EXIT] at this stage, it will quit without saving and return to VOICE menu.
5. Press [F3 (ENTER)] to enter RENAME menu. Now you can rename the user kit.

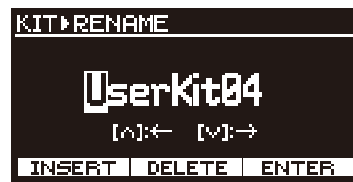
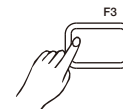

Button operation in RENAME menu:

Button	Description
[^]/[v]	Move the cursor to the left or to the right.
Data dial or [<]/[>]	Change the selected character.
[F1]	Insert a space on the left side of the selected character, and this character will move one space to the right.
[F2]	Delete the selected character, and the next character will move one space to the left.
[F3]	Confirm and save.
[EXIT]	Return to the previous menu.

**Note:** You can enter 12 characters at most for each name.

6. After renaming, press [F3 (ENTER)] to confirm and save the user kit. When saving successfully, the LCD will prompt "Save OK!", and then return to the corresponding KIT menu.
7. Unsupported save under iKit mode.

## Drum Kit

### Notes:

1. Kit parameters include voice and effect parameters for each trigger.
2. After editing, if you do not save it, the edited data will be lost when you select a different drum kit or turn off the module.
3. After editing, if you do not save the edited kit parameters but directly enter record mode, it will use the default kit settings for recording.
4. As long as you do not switch to a different drum kit, the currently edited voice settings will not be lost even when you select a different menu.

## Click

Click is a major function of digital drum. It helps you play in a steady tempo.

### Turn the click on/off

1. Press the [CLICK] button to enter CLICK menu and start playing the click. The button LED will blink in sync with the click sound.
2. Press the [CLICK] button again to exit CLICK menu and stop the click sound. The button LED turns off.

#### Note:

In CLICK menu, if you press [EXIT], it will exit CLICK menu, but will not stop the click sound.

### Editing Click Parameters

In CLICK menu, press the [ $\wedge$ ]/[ $\vee$ ] buttons to select a parameter, then use the data dial or [<]/[>] buttons to change the setting.

Click parameters and their range:

Parameter	Range	Description
Tempo	30 ~280	Click tempo
Voice	Click, Clave, Stick, CoClick, FmClick, Voice1, Voice2	Click voice
T-Sign	0/2~9/2, 0/4~9/4, 0/8~9/8, 0/16~9/16	Click time signature
Interval	1/2, 3/8, 1/4, 1/8, 1/12, 1/16	Click interval
Out	Phone, Main+Phone	To output the click sound from just the Phones jack or from the Phones and Output jacks.

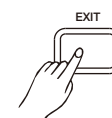
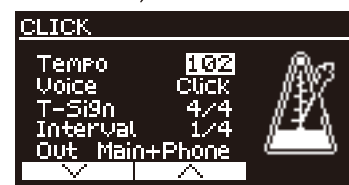
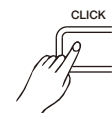

# Song

The module features a variety of preset songs and user songs. Try selecting your favorite songs and play along with them. Please refer to **Song List** for details.

## Playing Preset Songs

1. Press the [SONG] button to enter SONG ▶ MODULE menu.
2. Press the [^]/[v] buttons to select the song number item or the song volume item. Then use the data dial or [<]/[>] buttons to select a desired song or adjust the volume range from 000 to 127.
3. Press the [▶|■] button to start/stop playing the selected song. During playback, the LCD will display the measure count.
4. In SONG ▶ MODULE menu, press the [F1 (LIST)] to enter SONG ▶ LIST menu.
5. In SONG ▶ LIST menu, use the [^]/[v] buttons, the data dial or [<]/[>] buttons to select a desired song, then press the [▶|■] button to start/stop the playback.
6. In SONG ▶ LIST menu, press [F1 (GROUP)] to toggle between two song groups: PTN and USER. After selecting a song, press the [SONG] button to return to SONG ▶ MODULE menu.
7. In SONG ▶ MODULE menu or SONG ▶ LIST menu, press [F3 (TEMPO)] to display the current tempo. When tempo is displayed, use the data dial or [<]/[>] buttons to adjust the tempo from 30 to 280.

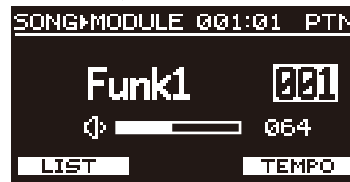

Song Groups:

Song	Group	Song No.	Description
Preset	Ptn	1~100	Pattern is rhythmic music. When pattern playback is finished, it will automatically start again from the beginning until you press the [▶ ■] button.
User	User	101~110	Recorded songs.

## Playing USB Songs

You can playback song files (MP3, WAV and MIDI) stored on a USB flash drive. The default song folder on USB flash drive is "/SONG". Up to 99 songs can be saved in one folder, but extra songs should be saved in a different folder. You can change the playback folder, please refer to Using USB Flash Drive. USB flash drive will become unrecognizable if there are more than 99 files under the root directory.

1. Press the [SONG] button to enter SONG menu.
2. Insert a USB flash drive to the module. The LCD will display the USB icon.

Press [F2] to toggle between USB songs and preset songs. Now press [F2 (USB)] to enter USB mode, and you can play back song files (MP3, WAV and MIDI) on the USB flash drive.

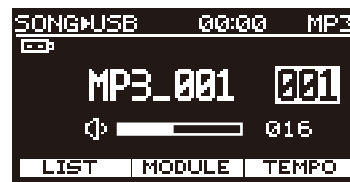
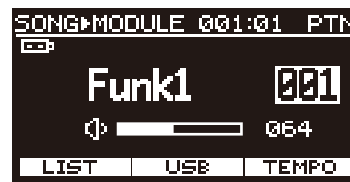
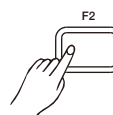



## Song

- Press [F1 (LIST)] to enter USB LIST menu. You can select a song from the list to play back.

### Notes:

- Format requirement of USB songs:
  - MP3:** bit rate≤320k bps; sample rate≤48KHz;
  - WAV:** 16 bit; sample rate≤48KHz;
  - MIDI:** format0 and format1; 32 tracks max.; PPQN≤480; max capacity of 128K byte.
- You can adjust the playback tempo of MIDI songs and the Click, but cannot change the tempo of MP3 and WAV songs.

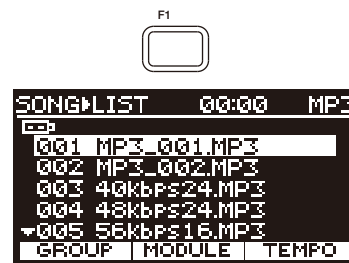

## Playing Along with a Song

- Select a desired song, then press the [▶|■] button to start playback. Now you can play along and strike the drum pads.
- To adjust the tempo of preset songs or the MIDI songs on USB flash drive, press the [F3 (TEMPO)] and then use the [<]/[>] buttons to change the tempo value.
- Press the [CLICK] to turn the click on or off.



## Recording

### MIDI Recording and MP3 Recording

The module supports MIDI recording and MP3 recording. MIDI recording will record your performance and save it as a user song on the module. MP3 recording will record your performance and save it to USB flash drive.

### Prepare and Start Recording

#### To record without song accompaniment:

In KIT menu, press the [●] button to enter record mode.

#### To record with song accompaniment:

In SONG menu, press the [●] button to enter record mode. It will use the selected song as accompaniment.

#### Take MIDI recording for example.

You can start MP3 recording in the same manner, but make sure a USB flash drive is properly connected to the module before recording starts.

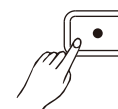

# Recording

1. Press the [ ● ] button to enter REC menu.  
The click will be turned on. You can press the [CLICK] button to mute the click sound, but the [CLICK] button LED will keep blinking.
2. In REC menu, you can adjust the following settings:
  - Use the data dial or [<]/>] buttons to select a user song to which recording will be saved.
  - Press [F1 (P-CNT)] to turn the pre-count function on or off.
  - Press [F3 (TEMPO)] to display the tempo, then use the data dial or [<]/>] buttons to change the tempo value.
  - Press [F2 (USB)] to enter MP3 REC menu. (This button is not available until a USB flash drive is properly connected to the module).
3. Press the [▶|■] button or simply hit a pad to start recording. Song accompaniment and drum performance will be recorded, but the click sound will not be recorded.

**Note:**

During recording, only these buttons are available: [F3 (STOP)], [CLICK], [EXIT] and [▶|■].

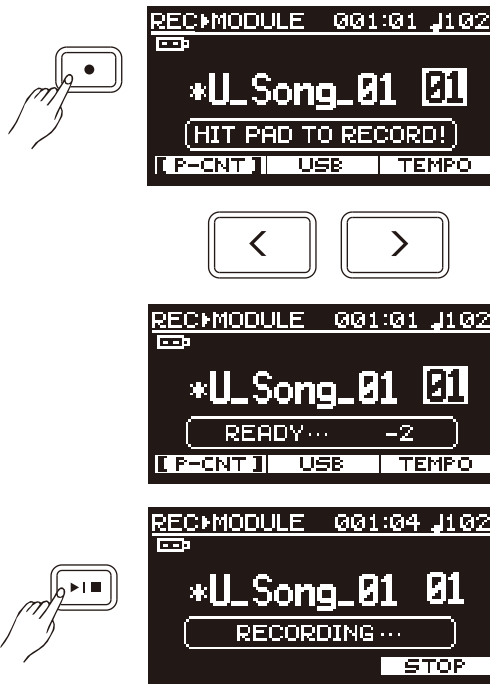

## Rename and Save MIDI Recording

During recording, you can press [F3 (STOP)], [▶|■] or [EXIT] to stop recording and enter RENAME menu.

Button operation in RENAME menu:

Button	Description
[^]/[v]	Move the cursor to the left or to the right.
Data dial or [<]/>]	Change the selected character.
[F1]	Insert a space on the left side of the selected character, and this character will move one space to the right.
[F2]	Delete the selected character, and the next character will move one space to the left.
[F3]	Confirm and save.
[EXIT]	Exit RENAME menu, and save it in the default name "U_Song_xx".

**NOTE:**

1. MP3 recording does not support RENAME, and the recorded song will be automatically saved as "SONG\_xxx.MP3".
2. You can enter 12 characters at most for a name.
3. If you use a user kit for MIDI recording, but switch to a different drum kit for playback, the playback effect may be different from recording.
4. When Click Output is configured as "Main+Phone", in MP3 recording, the click sound will also be recorded.
5. iKit mode supports only MP3 recording.



# Coach

Coach function provides very unique practice patterns which are designed especially for beginners to help them improve playing accuracy, speed and persistence, as well as other skills on the whole.

Press the [COACH] function to enter coach mode.



Coach mode contains three parts: Quiet Count, Beat Check and Change Up. Each of them has its own feature and the latter two provide score function.

**Note:**

In Beat Check or Change Up, if score function is disabled, you will hear a beat sound playing during the practice. However, if score function is in use, the beat sound will be muted, and you can follow the beat count on LCD and strike the pads.

## Quiet Count

Quiet Count is a fundamental practice of tempo. It will play a complete tempo demo at the beginning, and then mute the sound so that you can hit the pads in quiet count.

1. Press the [COACH] button to enter COACH menu, then press [F1 (QUIET)] to select Quiet Count.

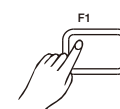

Quiet Count parameters and their range:

Parameter	Range	Description
01 ~ 05	01 ~ 05	Select a beat type.
Mode	1-1, 2-2, 1-3	<b>1-1:</b> play one measure of demo, then play one measure of quiet count; <b>2-2:</b> play two measures of demo, then play two measures of quiet count; <b>1-3:</b> play one measure of demo, then play three measures of quiet count;
Measure Hint	ON, OFF	Turn the accent hint on or off.
Tempo	30 ~ 280	Adjust the tempo.

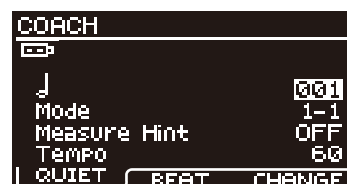

Press the [^]/[v] buttons to select a parameter, then use the data dial or [<]/[>] buttons to change the setting.

2. Press the [▶|■] button to start the practice.  
It will play a count-in of about one measure length, then play the demo with click sound. Try catching the beats. When demo stops, the click sound will be muted and "HIT!" will appear on LCD, indicating that you can hit the pad now. The LCD will show the accuracy of each hit. During practice, you can press [F3 (TEMPO)] to edit the tempo.

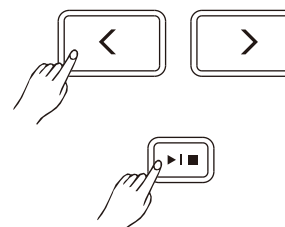

3. Press the [▶|■] button again to stop the practice.

**Note:**

During practice, you can check the accuracy of each hit on the LCD.



# Coach

## Beat Check

Beat Check helps improve your playing accuracy of each hit. It provides 15 different beat types. You can select a desired beat type and practice with click sound. Your performance will be scored when score function is in use.

1. Press the [COACH] button to enter COACH menu, then press [F2 (BEAT)] to select Beat Check.

Beat Check parameters and their range:

Parameter	Range	Description
	1 ~ 15	Select a beat type.
Score	OFF, ON(8Meas), ON(16Meas), ON(32Meas)	Turn the score function on or off; select the number of measures for practice.
Measure Hint	ON, OFF	Turn the accent hint on or off.
Tempo	30 ~ 280	Adjust the tempo.

Press the [^]/[v] buttons to select a parameter, then use the data dial or [<]/[>] buttons to change the setting.

2. Press the [▶|■] button to start the practice. It will play a count-in of about one measure length, then you can follow the click sound and strike the pad. The LCD will show the accuracy of each hit. During practice, you can press [F3 (TEMPO)] to edit the tempo.

3. Press the [▶|■] button again to stop the practice.

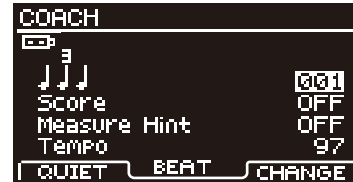
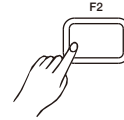

## Change Up

Change Up aims to foster your capacity to play with changing beats. It will play the first two measures of a beat type and then shift to a different beat type. Beat indicator on LCD will blink to indicate that it will change to this beat type in the next measure.

1. Press the [COACH] button to enter COACH menu, then press [F3 (CHANGE)] to select Change Up.

Beat Check parameters and their range:

Parameters	Range	Description
	1 ~ 3	Select a change-up pattern.
Score	OFF, ON(2Loop), ON(4Loop)	Turn the score function on or off; select the number of loops for practice.
Measure Hint	ON, OFF	Turn the accent hint on or off.
Tempo	30 ~ 280	Adjust the tempo.

Press the [^]/[v] buttons to select a parameter, then use the data dial or [<]/[>] buttons to change the setting.

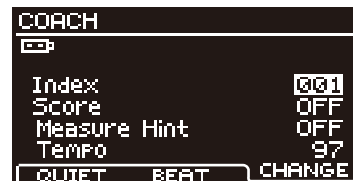
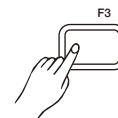

## Coach

### 2. Press the [▶|■] button to start the practice.

It will play a count-in of about one measure length, then you can start practice. The LCD will show the accuracy of each hit. Prior to beat changing, the beat indicator will blink and "CHANGE!" will appear on LCD, indicating it will change to this beat type in the next measure. During practice, you can press [F3 (TEMPO)] to edit the tempo.

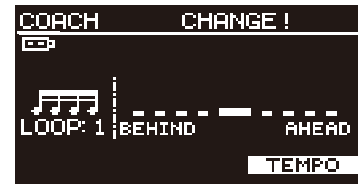

### 3. Press the [▶|■] button again to stop the practice.

#### **Note:**

When score function is in use, it will automatically stop and score the practice after the specified loops are finished.

# USB Memory

When a USB flash drive is connected to the module, the LCD will display the USB icon. Besides playing back MP3 songs and recording, you can also execute the following operations with USB flash drive:

1. Select a playback folder for playing back USB songs.
2. Load user voices from USB flash drive to the module.
3. Format the USB flash drive.

**Note:**

The module supports USB flash drives (4G to 64G) in FAT32 format. USB flash drives of trusted brand names, such as Kinston and SanDisk are preferable. We recommend formatting the USB flash drive on the module before using.

## Song Folder

You can save 99 songs at most in a folder on USB flash drive, and save extra songs in a different folder. The default song folder is "/SONG", but you can select a different folder to play back the songs in that folder.

1. Press the [SONG] button, then press the [MENU] button to enter USB menu.



2. Press the [^]/[V] buttons or [F1]/[F2] buttons to select "Song Folder", then press [F3 (ENTER)] to enter FOLDER menu.
3. Press the [^]/[V] buttons or [F1]/[F2] buttons to select a folder, then press [F3 (ENTER)] to confirm.

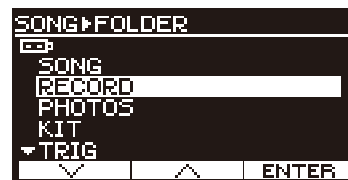
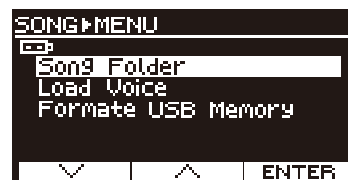

## Load Voice

You can load your favorite voice from USB flash drive to the module and use it as a user voice.

1. Press the [SONG] button, then press the [MENU] button to enter USB menu.
2. Press the [^]/[V] buttons to select "Load Voice", then press [F3 (ENTER)] to enter LOAD VOICE menu. The LCD will display voice files (.WAV) in the "/VOICE" folder.

**Notes:**

1. WAV format: 16 bit; 48k / 44.1k / 32k / 22.05k / 11.025k sampling rate.
2. Make sure the WAV files are in the "/VOICE" folder on USB flash drive. You can put 99 files at most in this folder. Total capacity of WAV files loaded to the module should be less than 15M Byte.

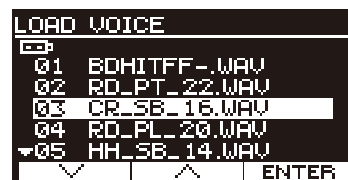
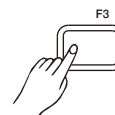

3. Press the [^]/[V] buttons or [F1]/[F2] buttons to select a desired WAV file, then press [F3 (ENTER)] to confirm. The LCD will display "Waiting..." to indicate that loading is in process.

# USB Memory

## Notes:

1. It will take a few minutes to finish loading a user voice, please wait patiently.
2. If the LCD displays "Unsupported file", it indicates this format does not meet requirement, please change it to the WAV format as specified above.
3. User voices cannot be edited or deleted. If the capacity is full, you can reset voice settings to factory default and erase all user voices. (Please refer to Factory Reset for details.) After voice reset, you can load voice files to the module as needed.
4. After voice reset, all user voices on the module are deleted. The user voices in user kits will be replaced by MUTE voices.
5. The loaded voices will be placed between the preset voices and the Hihat Combination voices, starting from no.651 with a voice number of "Uxx".

## Format USB Memory

After formatting, all data saved on USB flash drive will be erased. Please backup any important data before formatting.

1. Press the [SONG] button, then press the [MENU] button to enter USB menu.
2. Press the [^]/[V] buttons to select "Format USB memory", then press [F3 (ENTER)]. The LCD will prompt "Format the USB memory? Exit/Enter?"
3. Press [F3 (ENTER)] to confirm formatting, and the LCD will display "Waiting!".

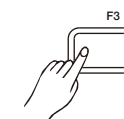
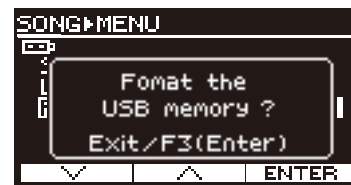

Or press the [EXIT] button to exit and return to the previous menu.



# Volume Sliders

You can use the volume sliders to adjust the relevant volumes respectively.

Press the [  ] button to select a group of parameters to edit. LED of the selected group will be lit. Now you can move the sliders to adjust the volumes of the selected group.

Upper Group (corresponding to the upper LED)	
KICK	Kick volume
SNARE	Snare volume
TOM1	Tom 1 volume
TOM2	Tom 2 volume
TOM3	Tom 3 volume
TOM4	Tom 4 volume
Lower Group (corresponding to the lower LED)	
HI-HAT	Hi-hat & hi-hat pedal volume
CRASH1	Crash 1 volume
CRASH2	Crash 2 volume
RIDE	Ride volume
KIT	Drum kit volume
SONG	Song playback volume

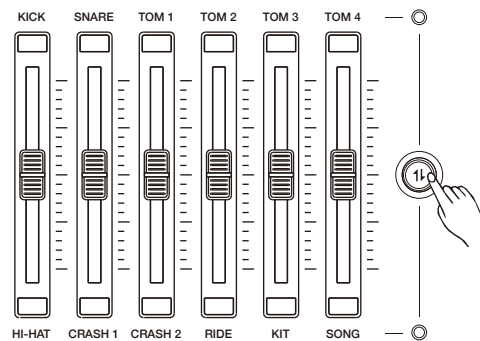

## For example, adjust the snare volume.

1. Press the [  ] button to select the upper group which the snare volume belongs to. The upper group LED will be lit.
2. Move the SNARE slider to adjust the snare volume.

### Note:

Pressing the [  ] button will not affect the current volume. The relevant volume will change only when you move the slider.



# Settings

## Trigger Settings

You can adjust trigger parameters to suit your playing habits and optimize the digital drum for best performance.

The module provides a group of preset trigger settings. You can edit the relevant parameters and save it on the module. If you do not save the edited data, it will be lost after power off..



### Editing Trigger Parameters

1. Press the [KIT] button, then press the [MENU] button.
2. Press the [^]/[v] buttons or [F1]/[F2] buttons to select "Trigger", then press [F3 (ENTER)] to enter TRIGGER menu.
3. Press the [^]/[v] buttons or [F1]/[F2] buttons to select a parameter to edit, then use the data dial or [<]/[>] buttons to change the setting. After editing, press [F3 (ENTER)] to save, otherwise, the edited data will be lost after power off.



### Trigger parameters and their range:

Parameter	Range	Description
Head Sensi	0 ~15	Adjust the pad sensitivity. A high value will produce loud sound, even you strike softly. A low value will produce low sound, even you strike heavily.
Rim Sensi	0 ~15	Adjust the sensitivity of rim shot.
Threshold	0 ~15	Trigger signal will produce sound only when it is above the threshold level. Although this setting can prevent unwanted sounding, such as crosstalk from other pads, if set to a higher level, no sound will be produced when you strike lightly. For example, B will produce sound but A and C will not. To get a proper threshold value: 1. Set the value to a low level. 2. Raise the value gradually while striking the pad. 3. Repeat step2 until you get an appropriate level.
Head/Rim Adj	0 ~15	Adjust the disturbance between head and rim shot. (Only for Snare and Tom)
X-STICK Level	0~4	When the value is set to "0", it plays only the rim shot sound, but no cross stick sound. As the value increases, the cross stick sound will be more noticeable. Note: This parameter is not available until X-Stick function is turned on in KIT menu.
X-Talk	0 ~15	Crosstalk means when hitting a pad, another pad is mistakenly triggered, which should have been avoided. This may happen when two pads sit on the same stand. For example: when you hit the Snare, if both Snare and Tom1 produce sound, you can raise Tom1's "XTALK" value to prevent crosstalk. Note: Make sure the "XTALK" value is set to a proper level. If the value is set too high, when you hit two pads at the same time, the pad being struck gently may be judged as "crosstalk" and will not produce sound.
Curve	Normal, EXP-1, EXP-2, LOG-1, LOG-2, Loud	This setting adjusts the relationship between the striking force and the response volume. Please refer to Curve description in this chapter.
Retrig-C	0~15	This setting is to cancel "re-triggering". Re-triggering means when you strike a pad, you hear two sounds from this strike because of pad vibration. Note: If the value is set too high, sounds may be omitted when you play fast; if the value is set too low, re-triggering may not be prevented. Better set the value to the minimum level required but still can prevent re-triggering.
Close Point	0~2	Adjust the close point settings:
Pedal Sensi	0~15	Adjust the sensitivity of hi-hat control pedal.
Splash-Sensi	0~5	Adjust the splash sensitivity. When set to a higher value, it becomes easier to play the splash.
Bow-Sensi	0 ~ 15	Adjust the sensitivity of cymbal bow.
Edge-Sensi	0 ~ 15	Adjust the sensitivity of cymbal edge.
Bell-Sensi	0 ~ 15	Adjust the sensitivity of cymbal bell.

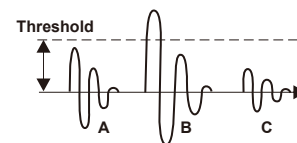

# Settings

## Curve description:

Curve	Description
Normal	The most natural setting. There is a linear change between playing dynamics and volume response.
Exp-1, Exp-2	Comparing to Normal, heavy strike will produce greater volume change.
Log-1, Log-2	Comparing to Normal, gentle strike will produce greater volume change.
Loud	Even a soft strike will produce strong volume, and the range of dynamic response is small. When a drum trigger is used as an external pad, reliable triggering can be made.

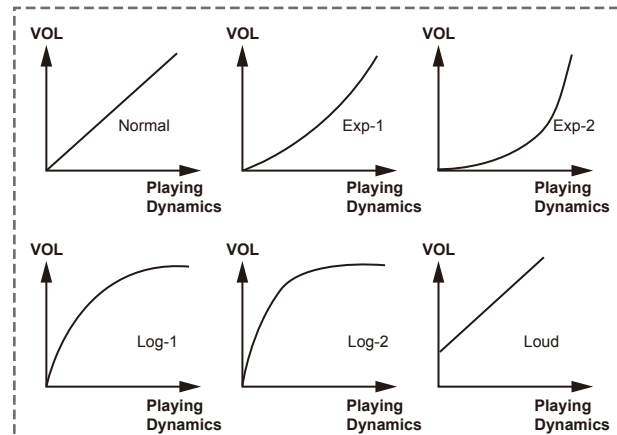

## Default MIDI notes of all triggers:

Trigger	MIDI	Trigger	MIDI	Trigger	MIDI	Trigger	MIDI	Trigger	MIDI
Kick	36	Tom1 Rim	50	Tom4 Head	41	Crash1 Bow	49	Close Hihat	42
Snare Head	38	Tom2 Head	45	Tom4 Rim	39	Crash1 Edge	55	Open Hihat Edge	26
Snare Stick	37	Tom2 Rim	47	Ride Bow	51	Crash2 Bow	57	Close Hihat Edge	22
Snare Rim	40	Tom3 Head	43	Ride Edge	59	Crash2 Edge	52	Pedal	44
Tom1 Head	48	Tom3 Rim	58	Ride Bell	53	Open Hihat	46	Hihat Splash	21

## Note:

Save the trigger settings after editing, otherwise, the edited data will be lost after power off.

## Master Compress

Master compress is very useful for professional drummers. It ensures the sound will not be distorted when playing at maximum volume level.

### Editing Master Compress Parameters

1. Press the [KIT] button, then press the [MENU] button.
2. Press the [^]/[v] buttons or [F1]/[F2] buttons to select "Master Compress", then press [F3 (ENTER)] to enter MASTER COM PRESS menu.
3. Press the [^]/[v] buttons or [F1]/[F2] buttons to select a parameter to edit, then use the data dial or [<]/[>] buttons to change the setting. After editing, press [F3 (ENTER)] to save, otherwise, the edited data will be lost after power off.

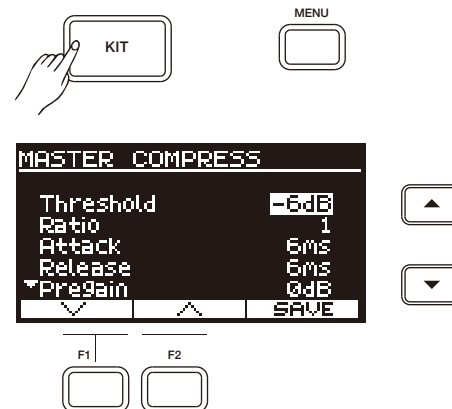

### Master Compress parameters and their range:

Parameter	Range	Description
Threshold	0 ~ -30dB	Only those signals that are above the threshold level will be compressed.
Ratio	1 ~25	Compression ratio.
Attack	6 ~50ms	The interval from when the volume goes above threshold until compression starts.
Release	6 ~699ms	The interval from when the volume falls under threshold until compression stops.
PreGain	-60 ~12dB	Output level of compression.

## MIDI Setup

1. Press the [KIT] button, then press the [MENU] button.
2. Press the [^]/[v] buttons or [F1]/[F2] buttons to select "Midi Setup", then press [F3 (ENTER)] to enter MIDI SETUP menu.
3. Press the [^]/[v] buttons or [F1]/[F2] buttons to select a parameter to edit, then use the data dial or [<]/[>] buttons to change the setting. After editing, press [F3 (ENTER)] to save, otherwise, the edited data will be lost after power off.

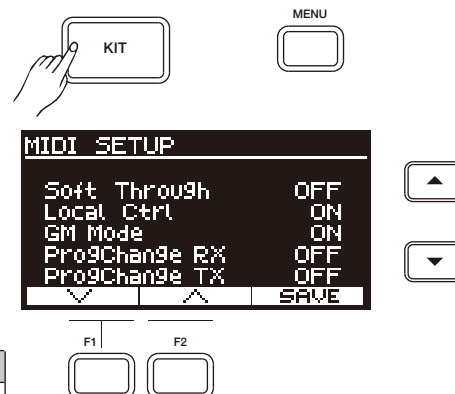

### MIDI Setup parameters and their range:

Parameter	Range	Description
Soft Through	ON, OFF	Message received from MIDI IN will be transmitted to MIDI OUT.
Local Control	ON, OFF	ON: Performance MIDI events from pads will be transmitted to the module and MIDI OUT. OFF: Performance MIDI events from pads will be transmitted to MIDI OUT only.
GM Mode	ON, OFF	ON: MIDI channel 10 will respond GM drum kit. OFF: MIDI channel 10 will respond local drum kit.
Prog Change RX	ON, OFF	ON: MIDI channel 10 will respond the program change MIDI message. OFF: MIDI channel 10 will ignore the program change MIDI message.
Prog Change TX	ON, OFF	ON: Send program change MIDI message from MIDI channel 10 when changing the local drum kit number. OFF: Do not send program change MIDI message from channel 10 when changing the local drum kit number.

## Auto Power Off

This function will automatically turn off the power after a period of time when the module is not in use.

Note: This function is not available during song playback, during recording or when MIDI IN jack is receiving data.

1. Press the [KIT] button, then press the [MENU] button.
2. Press the [^]/[v] buttons or [F1]/[F2] buttons to select "Option", then press [F3 (ENTER)] to enter OPTION menu.
3. Press the [^]/[v] buttons or [F1]/[F2] buttons to select a parameter to edit, then use the data dial or [<]/[>] buttons to change the setting. After editing, press [F3 (ENTER)] to save, otherwise, the edited data will be lost after power off.

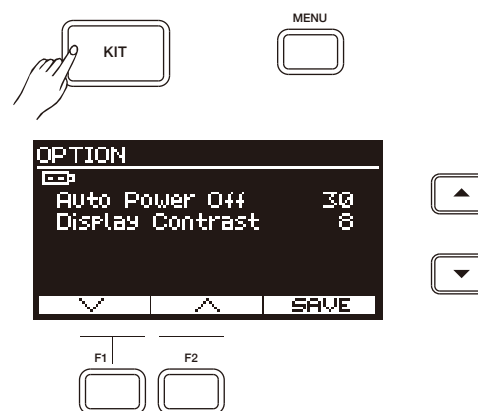

### Option parameters and their range:

Parameter	Range	Description
Auto Power Off	OFF, 30, 60	OFF: Auto power off is disabled. 30, 60: The module will shut down after 30 min or 60 min when it is not used.
Display Contrast	1~16	Adjust the contrast ratio of display.

# Settings

## Factory Reset

In Factory Reset, you can restore factory settings respectively for drum kits, songs, triggers, and voices.

1. Press the [KIT] button, then press the [MENU] button.
2. Press the [^]/[V] buttons or [F1]/[F2] buttons to select "Factory Reset", then press [F3 (ENTER)] to enter FACTORY RESET menu.
3. Press the [^]/[V] buttons or [F1]/[F2] buttons to select a parameter, then press [F3 (ENTER)] to proceed.



4. A confirmation message will prompt on LCD. Press [F3 (ENTER)] to execute factory reset; or press [EXIT] to cancel.

### Factory Reset parameters:

Parameter	Description
Kit Reset	Restore user drum kits to factory settings.
Song Reset	Restore user songs to factory settings.
Trigger Reset	Restore user trigger to factory settings.
Voice Reset	Delete all user voices.
All Reset	Parameters which will be restored to factory settings: user kits, user songs, user voices, user trigger, MIDI setting, Option setting and Master Compress setting etc.

### Note:

Do not turn off the power when factory reset is in progress. If power supply is accidentally disconnected, execute factory reset again, otherwise it may corrupt the internal data and cause malfunction.

# Specifications

<b>Drum Kits</b>
Kit: 50 Presets + 49 Users
<b>Voices</b>
Preset: 650 (Percussion Voice, Effect Voice)+ 17 Hi-hat Combination
User: 99 samples with approx. 15M Byte in total
<b>Sequencer</b>
Preset: 100
User: 10
USB flash drive: MP3, Wav and MIDI files; up to 99 files per folder.
Tick: 192 ticks per beat
Record: Real-time recording
Record Capacity: About 2000 notes per song.
<b>Tempo</b>
30~280
<b>Display</b>
64 x 128 dots graphic LCD with backlit
<b>Connectors</b>
TRIGGER INPUT(DB25 Type), TRIGGER IN (TOM4,CRASH2), PHONES(1/4"), AUX IN(1/8"), USB-MIDI, USB TO DEVICE, MIDI IN, MIDI OUT, OUTPUT (R,L/MONO)
<b>Control Buttons</b>
Power, Master Volume, Phone Volume, AUX IN Volume, Click Volume, Kit, Song, Record, Start/Stop, Click, Coach, Menu, [^], [v], Exit, F1,F2,F3, Data Dial, Group Faders, Fader Exchange,[<], [>]
<b>Power Supply</b>
DC 9V, 500mA
<b>Dimensions</b>
265(W) x 181(D) x 74(H)mm
<b>Module Weight</b>
0.98Kg

# Drum Kit List

No.	Kit Name
1	Standard 1
2	Acoustic 1
3	Funk
4	Rock
5	Brush 1
6	Latin
7	Funk Band
8	Dubstep
9	Beatbox 1
10	808
11	909
12	HipHop
13	Reggae
14	Jazz
15	Percussion 1
16	Indian
17	African
18	Room
19	Brush 2
20	Fusion
21	Vintage
22	Orchestra
23	Percussion 2
24	Marimba
25	Vibraphone

No.	Kit Name
26	Beatbox 2
27	Power
28	Teckno
29	Dance
30	Metal
31	Pop
32	World
33	Ska
34	Lo-Fi
35	R&B
36	Electronic
37	Magic
38	House
39	FX Mix
40	Big Band
41	Live
42	Old School
43	1970's
44	Jazz Latin
45	Junkyard
46	Noise
47	Acoustic 2
48	Standard 2
49	Studio 1
50	Studio 2

# iKit List

No	Kit Name
1	iStandard
2	iAcoustic
3	iFunk
4	iRock
5	iBrush

# Drum Voice List

No.	Voice Name
<b>KICK</b>	
1	22" Standard Kick 1
2	22" Standard Kick 2
3	Rock Kick
4	22" Acoustic Kick
5	22" Jazz Kick
6	Vintage Kick 1
7	Brush Kick
8	Funk Kick
9	Room Kick 1
10	Room Kick 2
11	Fusion Kick
12	1970's Kick
13	Vintage Kick 2
14	Reggae Kick
15	Big Band Kick
16	Old School Kick
17	Pop Kick
18	Magic Kick
19	Noise Kick
20	Beatbox Kick 1
21	Power Kick
22	808 Kick
23	909 Kick
24	Electronic Kick
25	Dance Kick
26	Beatbox Kick 2
27	FX Mix Kick
28	HipHop Kick
29	Techno Kick
30	Lo-Fi Kick
31	Junkyard Kick
<b>SNARE</b>	
32	14" Standard Snare 1
33	14" Standard Snare Rim 1
34	14" Rock Snare
35	14" Rock Snare Rim
36	14" Acoustic Snare
37	14" Acoustic Snare Rim
38	14" Funk Snare 1
39	14" Funk Snare Rim 1
40	14" Jazz Snare
41	14" Jazz Snare Rim
42	Room Snare
43	Room Snare Rim
44	Fusion Snare
45	Fusion Snare Rim
46	14" Standard Snare 2
47	14" Standard Snare Rim 2
48	14" Funk Snare 2
49	14" Funk Snare Rim 2
50	Vintage Snare
51	Vintage Snare Rim
52	Brush Snare 1

53	Brush Snare Rim 1
54	Brush Snare 2
55	Brush Snare Rim 2
56	Live Snare
57	Live Snare Rim
58	Orchestra Snare
59	Orchestra Snare Rim
60	Reggae Snare
61	Reggae Snare Rim
62	Old School Snare
63	Old School Snare Rim
64	R&B Snare
65	R&B Snare Rim
66	Dubstep Snare
67	Beatbox Snare 1
68	Beatbox Snare Rim 1
69	HipHop Snare
70	808 Snare
71	808 Snare Rim
72	909 Snare
73	909 Snare Rim
74	Electronic Snare
75	Power Snare
76	Dance Snare
77	Dance Snare Rim
78	House Snare
79	House Snare Rim
80	Lo-Fi Snare
81	Lo-Fi Snare Rim
82	Junkyard Snare
83	Junkyard Snare Rim
84	Noise Snare
85	Noise Snare Rim
86	Beatbox Snare 2
87	Beatbox Snare Rim 2
88	Techno Snare
89	Techno Snare Rim
90	Magic Snare
91	Magic Snare Rim
92	Standard Snare Stick 1
93	Rock Snare Stick
94	Acoustic Snare Stick
95	Funk Snare Stick 1
96	Jazz Snare Stick
97	Room Snare Stick
98	Fusion Snare Stick
99	Standard Snare Stick 2
100	Funk Snare Stick 2
101	Brush Snare Stick 1
102	Brush Snare Stick 2
103	Vintage Snare Stick
104	Live Snare Stick
105	Beatbox Snare Stick 1
106	Beatbox Snare Stick 2
107	808 Snare Stick

# Drum Voice List

108	909 Snare Stick
109	Electronic Snare Stick
110	Old School Snare Stick
111	House Snare Stick
112	Lo-Fi Snare Stick
113	Junkyard Snare Stick
114	Noise Snare Stick
115	Techno Snare Stick
116	Brush Swirl
<b>Tom</b>	
117	Standard Tom 1
118	Standard Tom 1 Rim
119	Standard Tom 2
120	Standard Tom 2 Rim
121	Standard Tom 3
122	Standard Tom 3 Rim
123	Standard Tom 4
124	Standard Tom 4 Rim
125	Standard Tom 5
126	Standard Tom 5 Rim
127	Standard Tom 6
128	Standard Tom 6 Rim
129	Rock Tom 1
130	Rock Tom 1 Rim
131	Rock Tom 2
132	Rock Tom 2 Rim
133	Rock Tom 3
134	Rock Tom 3 Rim
135	Rock Tom 4
136	Rock Tom 4 Rim
137	Rock Tom 5
138	Rock Tom 5 Rim
139	Rock Tom 6
140	Rock Tom 6 Rim
141	Acoustic Tom 1
142	Acoustic Tom 1 Rim
143	Acoustic Tom 2
144	Acoustic Tom 2 Rim
145	Acoustic Tom 3
146	Acoustic Tom 3 Rim
147	Acoustic Tom 4
148	Acoustic Tom 4 Rim
149	Acoustic Tom 5
150	Acoustic Tom 5 Rim
151	Acoustic Tom 6
152	Acoustic Tom 6 Rim
153	Brush Tom 1
154	Brush Tom 1 Rim
155	Brush Tom 2
156	Brush Tom 2 Rim
157	Brush Tom 3
158	Brush Tom 3 Rim
159	Brush Tom 4
160	Brush Tom 4 Rim
161	Brush Tom 5

162	Brush Tom 5 Rim
163	Brush Tom 6
164	Brush Tom 6 Rim
165	Funk Tom 1
166	Funk Tom 1 Rim
167	Funk Tom 2
168	Funk Tom 2 Rim
169	Funk Tom 3
170	Funk Tom 3 Rim
171	Funk Tom 4
172	Funk Tom 4 R
173	Funk Tom 5
174	Funk Tom 5 Rim
175	Funk Tom 6
176	Funk Tom 6 Rim
177	Vintage Tom 1
178	Vintage Tom 2
179	Vintage Tom 3
180	Vintage Tom 4
181	Vintage Tom 5
182	Vintage Tom 6
183	Fusion Tom 1
184	Fusion Tom 2
185	Fusion Tom 3
186	Fusion Tom 4
187	Fusion Tom 5
188	Fusion Tom 6
189	1970's Tom 1
190	1970's Tom 1 Rim
191	1970's Tom 2
192	1970's Tom 2 Rim
193	1970's Tom 3
194	1970's Tom 3 Rim
195	1970's Tom 4
196	1970's Tom 4 Rim
197	808 Tom 1
198	808 Tom 2
199	808 Tom 3
200	808 Tom 4
201	808 Tom 5
202	808 Tom 6
203	808 Tom Fx 1
204	808 Tom Fx 2
205	909 Tom 1
206	909 Tom 2
207	909 Tom 3
208	909 Tom 4
209	909 Tom 5
210	909 Tom 6
211	909 Tom 7
212	909 Tom 8
213	Electronic Tom 1
214	Electronic Tom 2
215	Electronic Tom 3
216	Electronic Tom 4





# Drum Voice List

217	Electronic Tom 5
218	Electronic Tom 6
219	Electronic Tom 7
220	Electronic Tom 8
221	Power Tom 1
222	Power Tom 2
223	Power Tom 3
224	Power Tom 4
225	Power Tom 5
226	Power Tom 6
227	Power Tom 7
228	Power Tom 8
229	Beatbox Tom 1
230	Beatbox Tom 2
231	Beatbox Tom 3
232	Beatbox Tom 4
233	Lo-Fi Tom 1
234	Lo-Fi Tom 1 Rim
235	Lo-Fi Tom 2
236	Lo-Fi Tom 2 Rim
237	Lo-Fi Tom 3
238	Lo-Fi Tom 3 Rim
239	Lo-Fi Tom 4
240	Lo-Fi Tom 4 Rim
241	Lo-Fi Tom 5
242	Lo-Fi Tom 5 Rim
243	Lo-Fi Tom 6
244	Lo-Fi Tom 6 Rim
245	Junkyard Tom 1
246	Junkyard Tom 1 Rim
247	Junkyard Tom 2
248	Junkyard Tom 2 Rim
249	Junkyard Tom 3
250	Junkyard Tom 3 Rim
251	Junkyard Tom 4
252	Junkyard Tom 4 Rim
253	Junkyard Tom 5
254	Junkyard Tom 5 Rim
255	Junkyard Tom 6
256	Junkyard Tom 6 Rim
257	Techno Tom 1
258	Techno Tom 1 Rim
259	Techno Tom 2
260	Techno Tom 2 Rim
261	Techno Tom 3
262	Techno Tom 3 Rim
263	Techno Tom 4
264	Techno Tom 4 Rim
265	Techno Tom 5
266	Techno Tom 5 Rim
267	Techno Tom 6
268	Techno Tom 6 Rim
269	Dubstep Tom 1
270	Dubstep Tom 1 Rim
271	Dubstep Tom 2

272	Dubstep Tom 2 Rim
273	Dubstep Tom 3
274	Dubstep Tom 3 Rim
275	Dubstep Tom 4
276	Dubstep Tom 4 Rim
<b>Ride</b>	
277	20" Standard Ride
278	20" Standard Ride Edge
279	20" Standard Ride Bell
280	20" Rock Ride
281	20" Rock Ride Edge
282	20" Rock Ride Bell
283	22" Acoustic Ride
284	22" Acoustic Ride Edge
285	22" Acoustic Ride Bell
286	20" Funk Ride
287	20" Funk Ride Edge
288	20" Funk Ride Bell
289	22" Funk Ride
290	22" Funk Ride Edge
291	22" Funk Ride Bell
292	Brush Ride 1
293	Brush Ride 2
294	20" Room Ride
295	20" Room Ride Edge
296	20" Room Ride Bell
297	20" Metal Ride
298	20" Metal Ride Edge
299	20" Metal Ride Bell
300	Vintage Ride
301	Vintage Ride Edge
302	Vintage Ride Bell
303	22" Big Band Ride
304	22" Big Band Ride Edge
305	22" Big Band Ride Bell
306	Old School Ride
307	Old School Ride Edge
308	Old School Ride Bell
309	808 Ride
310	Electronic Ride
311	Electronic Ride Edge
312	Electronic Ride Bell
313	Dance Ride
314	Dance Ride Edge
315	Dance Ride Bell
316	Lo-Fi Ride
317	Lo-Fi Ride Edge
318	Lo-Fi Ride Bell
319	Dubstep Ride
320	Noise Ride
321	Noise Ride Edge
322	Noise Ride Bell
323	Techno Ride
324	Techno Ride Edge
325	Techno Ride Bell

<b>Crash</b>	
326	16" Standard Crash 1
327	16" Standard Crash 1 Edge
328	Rock Crash
329	Rock Crash Edge
330	16" Acoustic Crash 1
331	16" Acoustic Crash 1 Edge
332	18" Jazz Crash 1
333	18" Jazz Crash 1 Edge
334	18" Jazz Crash 2
335	18" Jazz Crash 2 Edge
336	16" Standard Crash 2
337	16" Standard Crash 2 Edge
338	Brush Crash 1
339	Brush Crash 2
340	Funk Crash 1
341	Funk Crash 1 Edge
342	Funk Crash 2
343	Funk Crash 2 Edge
344	16" Acoustic Crash 2
345	16" Acoustic Crash 2 Edge
346	Orchestra Crash 1
347	Orchestra Crash 2
348	Orchestra Crash 3
349	Room Crash
350	Room Crash Edge
351	1970's Crash
352	1970's Crash Edge
353	Old School Crash 1
354	Old School Crash 1 Edge
355	Vintage Crash 1
356	Vintage Crash 1 Edge
357	Vintage Crash 2
358	Vintage Crash 2 Edge
359	Latin Crash 1
360	Latin Crash 1 Edge
361	Latin Crash 2
362	Latin Crash 2 Edge
363	China 1
364	China 1 Edge
365	China 2
366	China 2 Edge
367	Splash
368	Splash Edge
369	808Crash
370	909Crash 1
371	909Crash 2
372	HipHop Crash
373	Electronic Crash 1
374	Electronic Crash 2
375	Dance Crash 1
376	Dance Crash 2
377	Lo-Fi Crash 1
378	Lo-Fi Crash 1 Edge
379	Lo-Fi Crash 2

# Drum Voice List

380	Lo-Fi Crash 2 Edge
381	Techno Crash 1
382	Techno Crash 1 Edge
383	Techno Crash 2
384	Techno Crash 2 Edge
385	Beatbox Crash
386	Noise Crash 1
387	Noise Crash 2
<b>Hi-hat</b>	
388	14" Standard Hi-hat
389	14" Standard Hi-hat Edge
390	14" Standard Hi-hat Pedal
391	14" Standard Hi-hat Splash
392	14" Rock Hi-hat
393	14" Rock Hi-hat Edge
394	14" Rock Hi-hat Pedal
395	14" Rock Hi-hat Splash
396	14" Acoustic Hi-hat
397	14" Acoustic Hi-hat Edge
398	14" Acoustic Hi-hat Pedal
399	14" Acoustic Hi-hat Splash
400	14" Funk Hi-hat
401	14" Funk Hi-hat Edge
402	14" Funk Hi-hat Pedal
403	14" Funk Hi-hat Splash
404	Brush Hi-hat
405	Brush Hi-hat Pedal
406	Brush Hi-hat Splash
407	14" Jazz Hi-hat
408	14" Jazz Hi-hat Edge
409	14" Jazz Hi-hat Pedal
410	14" Jazz Hi-hat Splash
411	808 Hi-hat
412	808 Hi-hat Pedal
413	808 Hi-hat Splash
414	909 Hi-hat
415	909 Hi-hat Pedal
416	909 Hi-hat Splash
417	Dance Hi-hat
418	Dance Hi-hat Pedal
419	Dance Hi-hat Splash
420	Dubstep Hi-hat
421	Dubstep Hi-hat Pedal
422	Beatbox Hi-hat 1
423	Beatbox Hi-hat Pedal 1
424	Beatbox Hi-hat 2
425	Beatbox Hi-hat Pedal 2
426	Lo-Fi Hi-hat
427	Lo-Fi Hi-hat Edge
428	Lo-Fi Hi-hat Pedal
429	Lo-Fi Hi-hat Splash
<b>Percussion</b>	
430	Maracas
431	Sticks
432	Metronome Bell

433	Vibra-slap 1
434	Vibra-slap 2
435	Vibra-slap 3
436	Synthesis Percussion 1
437	Synthesis Percussion 2
438	High Q 1
439	High Q 2
440	Low Q 1
441	Low Q 2
442	Mute Hi Conga 1
443	Mute Hi Conga 2
444	Open Hi Conga 1
445	Open Hi Conga 2
446	Low Conga
447	High Bongo
448	Low Bongo
449	High Timbale 1
450	High Timbale 2
451	High Timbale 3
452	High Timbale 4
453	High Timbale 5
454	Low Timbale 1
455	Low Timbale 2
456	Low Timbale 2 Rim
457	Low Timbale 3
458	Low Timbale 4
459	High Agogo
460	Low Agogo
461	Claves 1
462	Claves 2
463	Jingle Bell 1
464	Jingle Bell 2
465	Cowbell
466	Bell Tree 1
467	Bell Tree 2
468	Tambourine 1
469	Tambourine 2
470	Cabasa
471	Long Guiro
472	Short Guiro
473	Click Bell
474	Click
475	Indian 1
476	Indian 2
477	Indian 3
478	Indian 4
479	Indian 5
480	Indian 6
481	Indian 7
482	Indian 8
483	Indian 9
484	Indian 10
485	Indian 11
486	Indian 12
487	Indian 13

488	Indian 14
489	Indian 15
490	Indian 16
491	Indian 17
492	African 1
493	African 2
494	African 3
495	African 4
496	African 5
497	African 6
498	African 7
499	African 8
500	African 9
501	African 10
502	African 11
503	African 12
504	African 13
505	African 14
506	African 15
507	African 16
508	African 17
509	Marimba C3
510	Marimba Db3
511	Marimba D3
512	Marimba Eb3
513	Marimba E3
514	Marimba F3
515	Marimba Gb3
516	Marimba G3
517	Marimba Ab3
518	Marimba A3
519	Marimba Bb3
520	Marimba B3
521	Marimba C4
522	Marimba Db4
523	Marimba D4
524	Marimba Eb4
525	Marimba E4
526	Marimba F4
527	Marimba Gb4
528	Marimba G4
529	Marimba Ab4
530	Marimba A4
531	Marimba Bb4
532	Marimba B4
533	Marimba C5
534	Marimba Db5
535	Marimba D5
536	Marimba Eb5
537	Marimba E5
538	Marimba F5
539	Marimba Gb5
540	Marimba G5
541	Marimba Ab5
542	Marimba A5

# Drum Voice List

543	Marimba Bb5
544	Marimba B5
545	Marimba C6
546	Vibraphone C3
547	Vibraphone Db3
548	Vibraphone D3
549	Vibraphone Eb3
550	Vibraphone E3
551	Vibraphone F3
552	Vibraphone Gb3
553	Vibraphone G3
554	Vibraphone Ab3
555	Vibraphone A3
556	Vibraphone Bb3
557	Vibraphone B3
558	Vibraphone C4
559	Vibraphone Db4
560	Vibraphone D4
561	Vibraphone Eb4
562	Vibraphone E4
563	Vibraphone F4
564	Vibraphone Gb4
565	Vibraphone G4
566	Vibraphone Ab4
567	Vibraphone A4
568	Vibraphone Bb4
569	Vibraphone B4
570	Vibraphone C5
571	Vibraphone Db5
572	Vibraphone D5
573	Vibraphone Eb5
574	Vibraphone E5
575	Vibraphone F5
576	Vibraphone Gb5
577	Vibraphone G5
578	Vibraphone Ab5
579	Vibraphone A5
580	Vibraphone Bb5
581	Vibraphone B5
582	Vibraphone C6
583	Orchestra Timpani C2
584	Orchestra Timpani Db2
585	Orchestra Timpani D2
586	Orchestra Timpani Eb2
587	Orchestra Timpani E2
588	Orchestra Timpani F2
589	Orchestra Timpani Gb2
590	Orchestra Timpani G2
591	Orchestra Timpani Ab2
592	Orchestra Timpani A2
593	Orchestra Timpani Bb2
594	Orchestra Timpani B2
595	Orchestra Timpani C3
596	Orchestra Timpani Db3
597	Orchestra Timpani D3

598	Orchestra Timpani E3
599	Orchestra Timpani F3
600	Orchestra Timpani G3
601	Orchestra Timpani A3
602	Orchestra Timpani B3
603	Orchestra Timpani C4
<b>FX</b>	
604	FX 1
605	FX 2
606	FX 3
607	FX 4
608	FX 5
609	FX 6
610	FX 7
611	FX 8
612	FX 9
613	FX 10
614	FX 11
615	FX 12
616	FX 13
617	FX 14
618	FX 15
619	FX 16
620	FX 17
621	FX 18
622	FX 19
623	FX 20
624	FX 21
625	FX 22
626	FX 23
627	FX 24
628	FX 25
629	FX 26
630	FX 27
631	FX 28
632	FX 29
633	FX 30
634	FX 31
635	FX 32
636	FX 33
637	FX 34
638	FX 35
639	FX 36
640	FX 37
641	One & Stick
642	Two & Stick
643	Three & Stick
644	Four & Stick
645	Five & Stick
646	Six & Stick
647	Seven & Stick
648	Eight & Stick
649	Nine & Stick
650	Mute

HI-HAT Combination	
HH01	Standard
HH02	Rock
HH03	Acoustic
HH04	Funk
HH05	Brush
HH06	Jazz
HH07	808
HH08	909
HH09	Dance
HH10	Dubstep
HH11	Beatbox1
HH12	Beatbox2
HH13	Lo-Fi
HH14	Marimba
HH15	Vibra
HH16	Indian
HH17	African

# Song List

No.	Song Name	LCD Name
1	Funk1	Funk1
2	Rock N'Roll1	R'N'R1
3	Dance1	Dance1
4	Pop1	Pop1
5	Fusion1	Fusion1
6	R&B1	R&B1
7	Dubstep1	Dubstep1
8	R&B2	R&B2
9	Dubstep2	Dubstep2
10	Rock Ballad	RkBallad
11	Folk	Folk
12	Funk Shuffle	FunkShuf
13	Ele Pop1	ElePop1
14	Pop2	Pop2
15	Bossa Nova1	Bossa1
16	Samba1	Samba1
17	Fusion2	Fusion2
18	Ele Pop2	ElePop2
19	Pop Shuffle	PopShuff
20	Rock1	Rock1
21	Latin1	Latin1
22	Latin2	Latin2
23	Salsa1	Salsa1
24	Smoove	Smoove
25	Steve Vai Funk	SteveVFk
26	70's Funk	70'sFunk
27	Jazz1	Jazz1
28	6/8Soul1	6/8Soul1
29	Fusion3	Fusion3
30	Dance funk	Dancfunk
31	Dance2	Dance2
32	DJ.House	DJ.House
33	Ele Pop3	ElePop3
34	Hip Hop	HipHop
35	Pop3	Pop3
36	Pop4	Pop4
37	R&B3	R&B3
38	Reggae1	Reggae1
39	Rock2	Rock2
40	Rock3	Rock3
41	Blues Funk	BluesFnk
42	Fusion4	Fusion4
43	Cool Jazz	CoolJazz
44	Ballad	Ballad
45	Samba2	Samba2
46	Vintage Hip-Hop	VtHipHop
47	Nu Jazz Funk	NuJazzFk
48	Soul	Soul
49	R&B4	R&B4
50	Big Band 1	BigBand1

51	Ska	Ska
52	Classic Rock	ClassRk
53	Hardcore Hip-Hop	HcHipHop
54	Vintage Dance Pop	VtDcPop
55	Nu-Metal	Nu-Metal
56	Salsa2	Salsa2
57	Eu Hip-Hop	EuHipHop
58	Bossa Nova2	Bossa2
59	Fusion 5	Fusion5
60	8Beat Pop	8BeatPop
61	Jazzy Funk	JazzyFnk
62	Swing Big Band	SwBgBand
63	Raggae 2	Raggae2
64	60's Pop	60'sPop
65	Vintage Funk	VtgFunk
66	Trance	Trance
67	Heavy Rock	HeavyRk
68	Swing	Swing
69	Punk	Punk
70	8Beat	8Beat
71	Disco House	DiscoHs
72	3/4 Folk	3/4Folk
73	Samba3	Samba3
74	Latin Rock	LatinRk
75	Reggae 3	Reggae3
76	Dance3	Dance3
77	Country Pop	CtryPop
78	Country	Country
79	PopRock	PopRock
80	DancePop	DancePop
81	Bebop	Bebop
82	Rock N'Roll2	R'N'R2
83	Band Jazz	BandJazz
84	Blues	Blues
85	3/4 Jazz	3/4Jazz
86	80's Metal	80sMetal
87	Drum N'Bass	D'N'B
88	6/8Soul2	6/8Soul2
89	Latin Swing	LtnSwing
90	Funk2	Funk2
91	Break Beat	BrkBeat
92	Latin Jazz	LtnJazz
93	TripHop	TripHop
94	Brit Pop	Britpop
95	Neo-Thrash	Neo-Thra
96	BigBand 2	BigBand2
97	Mambo	Mambo
98	Shuffle	Shuffle
99	GtrBossa	GtrBossa
100	Latin Dance	LtnDance

# GM Drum Kit List

No.	GM Percussion Kit	Rock Set(BANK0)	Standard Set(BANK8)	Funk Set(BANK16)	808 Set(BANK24)
Eb1[27]	High Q				
E 1[28]	Slap				
F 1[29]	Scratch Push				
F#1[30]	Scratch Pull				
G 1[31]	Sticks				
G#1[32]	Square Click				
A 1[33]	Metronome Click				
Bb1[34]	Metronome Bell				
B 1[35]	Acoustic Bass Drum				
C 2[36]	Bass Drum 1	Rock Kick	Standard Kick	Funk Kick	808 Kick
C#2[37]	Side Stick				
D 2[38]	Acoustic Snare	Rock Snare 1	Standard Snare 1	Funk Snare 1	808 Snare 1
Eb2[39]	Hand Clap				
E 2[40]	Electric Snare	Rock Snare 2	Standard Snare 2	Funk Snare 2	808 Snare 2
F 2[41]	Low Floor Tom	Rock Tom 4	Standard Tom 4	Funk Tom 4	808 Tom 4
F#2[42]	Closed Hi-hat	Rock Closed Hi-hat	Standard Closed Hi-hat	Funk Closed Hi-hat	808 Closed Hi-hat
G 2[43]	High Floor Tom	Rock Tom 3	Standard Tom 3	Funk Tom 3	808 Tom 3
G#2[44]	Pedal Hi-hat	Rock Pedal Hi-hat	Standard Pedal Hi-hat	Funk Pedal Hi-hat	808 Pedal Hi-hat
A 2[45]	Low Tom	Rock Tom 2	Standard Tom 2	Funk Tom 2	808 Tom 2
Bb2[46]	Open Hi-hat	Rock Open Hi-hat	Standard Open Hi-hat	Funk Open Hi-hat	808 Open Hi-hat
B 2[47]	Low-Mid Tom				
C 3[48]	High Mid Tom	Rock Tom 1	Standard Tom 1	Funk Tom 1	808 Tom 1
C#3[49]	Crash Cymbal 1	Rock Crash 1	Standard Crash 1	Funk Crash 1	808 Crash 1
D 3[50]	High Tom 1				
Eb3[51]	Ride Cymbal 1	Rock Ride	Standard Ride	Funk Ride	808 Ride
E 3[52]	China Cymbal				
F 3[53]	Ride Bell	Rock Ride Bell	Standard Ride Bell	Funk Ride Bell	808 Ride Bell
F#3[54]	Tambourine				
G 3[55]	Splash Cymbal				
G#3[56]	Cowbell				
A 3[57]	Crash Cymbal 2	Rock Crash 2	Standard Crash 2	Funk Crash 2	808 Crash 2
Bb3[58]	Vibra-slap				
B 3[59]	Ride Cymbal 2				
C 4[60]	High Bongo				
C#4[61]	Low Bongo				
D 4[62]	Mute Hi Conga				
Eb4[63]	Open Hi Conga				
E 4[64]	Low Conga				
F 4[65]	High Timbale				
F#4[66]	Low Timbale				
G 4[67]	High Agogo				
G#4[68]	Low Agogo				
A 4[69]	Cabasa				
Bb4[70]	Maracas				
B 4[71]	Short Whistle				
C 5[72]	Long Whistle				
C#5[73]	Short Guiro				
D 5[74]	Long Guiro				
Eb5[75]	Claves				
E 5[76]	Hi Wood Block				
F 5[77]	LowWood Block				
F#5[78]	Mute Cuica				
G 5[79]	Open Cuica				
G#5[80]	Mute Triangle				
A 5[81]	Open Triangle				
Bb5[82]	Shaker				
B 5[83]	Jingle Bell				
C 6[84]	Bell Tree				
C#6[85]	Castanets				
D 6[86]	Mute Surdo				
Eb6[87]	Open Surdo				

# GM Drum Kit List

No.	909 Set(BANK25)	Acoustic Set(BANK32)	Brush Set(BANK40)	Dupstep1 Set(BANK48)	Dupstep2 Set(BANK56)
Eb1[27]					
E 1[28]					
F 1[29]					
F#1[30]					
G 1[31]					
G#1[32]					
A 1[33]					
Bb1[34]					
B 1[35]					
C 2[36]	909 Kick	Acoustic Kick	Brush Kick	Dupstep1 Kick	Dupstep2 Kick
C#2[37]					
D 2[38]	909 Snare 1	Acoustic Snare 1	Brush Snare 1	Dupstep1 Snare 1	Dupstep2 Snare 1
Eb2[39]					
E 2[40]	909 Snare 2	Acoustic Snare 2	Brush Snare 2	Dupstep1 Snare 2	Dupstep2 Snare 2
F 2[41]	909 Tom 4	Acoustic Tom 4	Brush Tom 4	Dupstep1 Tom 4	Dupstep2 Tom 4
F#2[42]	909 Closed Hi-hat	Acoustic Closed Hi-hat	Brush Closed Hi-hat	Dupstep1 Closed Hi-hat	Dupstep2 Closed Hi-hat
G 2[43]	909 Tom 3	Acoustic Tom 3	Brush Tom 3	Dupstep1 Tom 3	Dupstep2 Tom 3
G#2[44]	909 Pedal Hi-hat	Acoustic Pedal Hi-hat	Brush Pedal Hi-hat	Dupstep1 Pedal Hi-hat	Dupstep2 Pedal Hi-hat
A 2[45]	909 Tom 2	Acoustic Tom 2	Brush Tom 2	Dupstep1 Tom 2	Dupstep2 Tom 2
Bb2[46]	909 Open Hi-hat	Acoustic Open Hi-hat	Brush Open Hi-hat	Dupstep1 Open Hi-hat	Dupstep2 Open Hi-hat
B 2[47]					
C 3[48]	909 Tom 1	Acoustic Tom 1	Brush Tom 1	Dupstep1 Tom 1	Dupstep2 Tom 1
C#3[49]	909 Crash 1	Acoustic Crash 1	Brush Crash 1	Dupstep1 Crash 1	Dupstep2 Crash 1
D 3[50]					
Eb3[51]	909 Ride	Acoustic Ride	Brush Ride	Dupstep1 Ride	Dupstep2 Ride
E 3[52]					
F 3[53]	909 Ride Bell	Acoustic Ride Bell	Brush Ride Bell	Dupstep1 Ride Bell	Dupstep2 Ride Bell
F#3[54]					
G 3[55]					
G#3[56]					
A 3[57]	909 Crash 2	Acoustic Crash 2	Brush Crash 2	Dupstep1 Crash 2	Dupstep2 Crash 2
Bb3[58]					
B 3[59]					
C 4[60]					
C#4[61]					
D 4[62]					
Eb4[63]					
E 4[64]					
F 4[65]					
F#4[66]					
G 4[67]					
G#4[68]					
A 4[69]					
Bb4[70]					
B 4[71]					
C 5[72]					
C#5[73]					
D 5[74]					
Eb5[75]					
E 5[76]					
F 5[77]					
F#5[78]					
G 5[79]					
G#5[80]					
A 5[81]					
Bb5[82]					
B 5[83]					
C 6[84]					
C#6[85]					
D 6[86]					
Eb6[87]					

# GM Backing Voice List

PIANO		BASS		BRASS		PAD	
1	Acoustic Grand Piano	33	Acoustic Bass	57	Trumpet	89	Pad1 (newage)
2	Bright Acoustic Piano	34	Finger Bass	58	Trombone	90	Pad2 (warm)
3	Electric Grand Piano	35	Pick Bass	59	Tuba	91	Pad3 (polysynth)
4	Honky-Tonk Piano	36	Fretless Bass	60	Muted Trumpet	92	Pad4 (choir)
5	E.Piano 1	37	Slap Bass 1	61	French Horn	93	Pad5 (bowed)
6	E.Piano 2	38	Slap Bass 2	62	Brass Section	94	Pad6 (metallic)
7	Harpsichord	39	Synth Bass 1	63	Synth Brass 1	95	Pad7 (halo)
8	Clavi	40	Synth Bass 2	64	Synth Brass 2	96	Pad8 (sweep)
MALLET		SOUNDEFFECTS		REED		EFFECTS	
9	Celesta	121	Guitar Fret Noise	65	Soprano Sax	97	FX1 (rain)
10	Glockenspiel	122	Breath Noise	66	Alto Sax	98	FX2 (soundtrack)
11	Music Box	123	Seashore	67	Tenor Sax	99	FX3 (crystal)
12	Vibraphone	124	Bird Tweet	68	Baritone Sax	100	FX4 (atmosphere)
13	Marimba	125	Telephone Ring	69	Oboe	101	FX5 (brightness)
14	Xylophone	126	Helicopter	70	English Horn	102	FX6 (goblins)
15	Tubular Bells	127	Applause	71	Bassoon	103	FX7 (echoes)
16	Dulcimer	128	Gunshot	72	Clarinet	104	FX8 (sci-fi)
ORGAN		STRINGS		PIPE		ETHNIC	
17	Drawbar Organ	41	Violin	73	Piccolo	105	Sitar
18	Percussive Organ	42	Viola	74	Flute	106	Banjo
19	Rock Organ	43	Cello	75	Recorder	107	Shamisen
20	Church Organ	44	Contrabass	76	Pan Flute	108	Koto
21	Reed Organ	45	Tremolo Strings	77	Blown Bottle	109	Kalimba
22	Accordion	46	Pizzicato Strings	78	Shakuhachi	110	Bagpipe
23	Harmonica	47	Orchestral Harp	79	Whistle	111	Fiddle
24	Tango Accordion	48	Timpani	80	Ocarina	112	Shanai
GUITAR		STRINGSENSEMBLE		LEAD		PERCUSSIVE	
25	Nylon Guitar	49	Strings Ensemble 1	81	Lead1 (square)	113	Tinkle Bell
26	Steel Guitar	50	Strings Ensemble 2	82	Lead2 (sawtooth)	114	Agogo
27	Jazz Guitar	51	Synth Strings 1	83	Lead3 (calliope)	115	Steel Drums
28	Clean Guitar	52	Synth Strings 2	84	Lead4 (cliff)	116	Wood Block
29	Muted Guitar	53	Choir Aahs	85	Lead5 (charang)	117	Taiko Drum
30	Overdriven Guitar	54	Voice Oohs	86	Lead6 (voice)	118	Melodic Tom
31	Distortion Guitar	55	Synth Voice	87	Lead7 (fifths)	119	Synth Drum
32	Guitar Harmonics	56	Orchestra Hit	88	Lead8 (bass & lead)	120	Reverse Cymbal

# MIDI Implementation Chart

Function...		Transmitted	Recognized	Remarks
Basic	Default	10ch	1 – 16	
Channel	Changed	x	x	
Mode	Default	x	x	
	Messages Altered	x *****	x *****	
Note		0 – 127	0 – 127	
Number:	True voice	*****	0 – 127	
Velocity	Note on	<input type="radio"/> 99H, V=1-127	<input type="radio"/>	
	Note off	<input type="radio"/> (99H, V=0)	<input type="radio"/>	
After	Key's	x	<input type="radio"/>	
	Touch Channel's	x	x	
Pitch Bend		x	<input type="radio"/>	
Control Change	0	x	<input type="radio"/>	Bank Select
	1	x	<input type="radio"/>	Modulation
	5	x	<input type="radio"/>	Portamento Time
	6	x	<input type="radio"/>	Data Entry
	7	x	<input type="radio"/>	Volume
	10	x	<input type="radio"/>	Pan
	11	x	<input type="radio"/>	Expression
	64	x	<input type="radio"/>	Sustain Pedal
	65	x	<input type="radio"/>	Portamento ON/OFF
	66	x	<input type="radio"/>	Sostenuto Pedal
	67	x	<input type="radio"/>	Soft Pedal
	80	x	<input type="radio"/>	Reverb Program
	81	x	<input type="radio"/>	Chorus Program
	91	x	<input type="radio"/>	Reverb Level
93	x	<input type="radio"/>	Chorus Level	
120	x	<input type="radio"/>	All Sound Off	
121	x	<input type="radio"/>	Reset All Controllers	
123	x	<input type="radio"/>	All Notes Off	
Program		<input type="radio"/>	<input type="radio"/>	
Change	: True #	xxxxxxx	0 – 127	
System	Exclusive	x	<input type="radio"/>	
System Common	: Song Position	x	x	
	: Song Select	x	x	
	: Tune	x	x	
System Real Time	: Clock Commands	<input type="radio"/>	x	
	: Commands	<input type="radio"/>	x	START and STOP only
Aux	: Local ON/OFF	x	x	
	: All Notes OFF	x	x	
Messages	: Active Sense	x	x	
	: Reset	x	x	

O : YES X : NO



# Prompt Messages

No.	LCD Message	Description
<b>Notification/Warning</b>		
1	Name invalid!	(Rename) File name is invalid. Input at least one character for file name.
2	Characters too long!	(Rename) The number of characters exceeds the limit. Decrease the number.
3	The 1st character can't be a SPACE!	(Rename) Make sure the 1st character is not a blank space.
4	Duplicate name!	(Rename) File name already exists. Input a different name.
5	Save ok!	Saving is successful.
6	Save failed!	Saving is failed.
7	Load ok!	Loading user voice is successful.
8	Load failed!	Loading user voice is failed.
9	Reset ok!	Factory reset is successful.
10	Format ok!	Formatting USB flash drive is successful.
11	Waiting	Please wait patiently.
12	Processing	(USB flash drive) Data is under processing.
13	No file!	There are no files in the current folder on USB flash drive.
14	Unsupported file!	The file format is not supported.
15	Unsupported USB!	Cannot recognize the connected USB flash drive.
16	USB ERROR!	There is abnormal operation of USB flash drive.
17	Record number exceeds the limit!	The file number of MP3 recording exceeds the limit.
18	Record time's up!	The time length of MP3 recording exceeds the limit.
19	USB disk is full!	USB flash drive is full. Delete unnecessary files on USB flash drive.
20	Record memory full!	The memory of MIDI recording is full.
21	User voice memory full!	The memory of user voice is full.
22	Can't edit in iKit mode!	Parameters are not editable in iKit mode.
23	Unsupported record under iKit mode!	MIDI recording is not supported in iKit mode.
<b>Inquiry/Confirmation</b>		
24	Reset user kit data?	Confirm to delete all user kit data.
25	Reset user song data?	Confirm to delete all user song data.
26	Reset user voice data?	Confirm to delete all user voice data.
27	Reset user trigger data?	Confirm to reset user trigger to factory default.
28	Reset user all data?	Confirm to reset all user data and settings to factory default.
29	Load to user voice?	Confirm to load the selected sample to the module as a user voice.
30	Format the USB memory?	Confirm to format the USB flash drive.

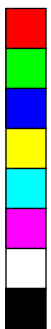

DD638\_G02