

# DIGITAL PIANO

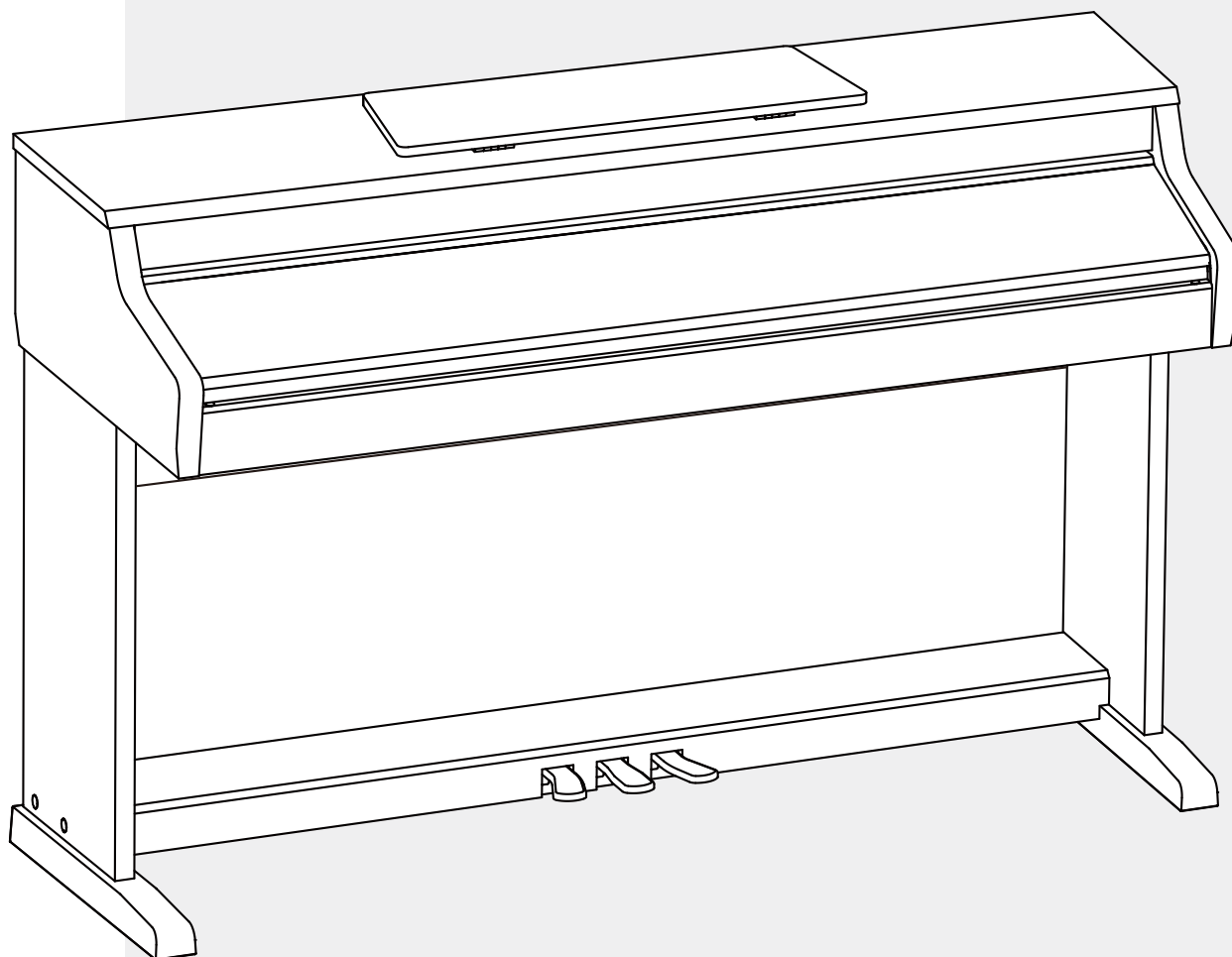

## Owner's Manual

# INFORMATION FOR YOUR SAFETY!

## THE FCC REGULATION WARNING (for USA)

This equipment has been tested and found to comply with the limits for a Class B digital device, pursuant to Part 15 of the FCC Rules.

These limits are designed to provide reasonable protection against harmful interference in a residential installation. This equipment generates, uses, and can radiate radio frequency energy and, if not installed and used in accordance with the instructions, may cause harmful interference to radio communications. However, there is no guarantee that interference will not occur in a particular installation. If this equipment does cause harmful interference to radio or television reception, which can be determined by turning the equipment off and on, the user is encouraged to try to correct the interference by one or more of the following measures:

- Reorient or relocate the receiving antenna.
- Increase the separation between the equipment and receiver.
- Connect the equipment into an outlet on a circuit different from that to which the receiver is connected.
- Consult the dealer or an experienced radio/TV technician for help.

Unauthorized changes or modification to this system can void the user's authority to operate this equipment.

### CAUTION

The normal function of the product may be disturbed by Strong Electro Magnetic Interference. If so, simply reset the product to resume normal operation by following the owner's manual. In case the function could not resume, please use the product in other location.

## PRECAUTIONS

### PLEASE READ CAREFULLY BEFORE PROCEEDING

Please keep this manual in a safe place for future reference.

#### Power Supply

When removing the electric plug from an outlet, always hold the plug itself and not the cord.

Do not connect the instrument to an electrical outlet using a multiple-connector or an AC outlet of voltage other than that for which your instrument is intended.

Remove the electric plug from the outlet when the instrument is not to be used for extended periods of time, or during electrical storms.

#### Connections

Before connecting the instrument to other devices, turn off the power to all units. This will help prevent malfunction and / or damage to other devices.

#### Location

Do not expose the instrument to the following conditions to avoid deformation, discoloration, or more serious damage:

- Direct sunlight
- Extreme temperature or humidity
- Excessive dusty or dirty location
- Strong vibrations or shocks
- Close to magnetic fields

#### Interference with other electrical devices

Radios and televisions placed nearby may experience reception interference. Operate this unit at a suitable distance from radios and televisions.

#### Cleaning

Clean only with a soft, dry cloth.

Do not use paint thinners, solvents, cleaning fluids, or chemical-impregnated wiping cloths.

#### Handling

Do not apply excessive force to the switches or controls. Do not let paper, metallic, or other objects into the instrument. If this happens, remove the electric plug from the outlet. Then have the instrument inspected by qualified service personnel.

Disconnect all cables before moving the instrument.

# Contents

## Panel & Display Description

Front Panel.....	4
LCD Display.....	4
Rear Panel.....	5

## Setup

Setup Guide.....	6
------------------	---

## Connections

Power Jack.....	9
Connecting a pair of Headphones.....	9
Connecting an Audio Equipment.....	9
Connecting an MP3/CD Player.....	9
Connecting a Computer.....	10
Connecting external MIDI devices.....	10

Adjusting the Master Volume.....	11
----------------------------------	----

Adjusting the Voice Brilliance.....	11
-------------------------------------	----

Playing the Demo Song.....	11
----------------------------	----

## Playing Voices

Playing Voices.....	12
Playing two voices simultaneously-DUAL.....	12
Playing Different Voices with Both hands-LOWER.....	12

Twinova.....	13
--------------	----

## Auto Accompaniment

Play Auto Accompaniment(rhythm track only).....	13
Play Auto Accompaniment(all tracks).....	13
Accompaniment Sections.....	14
Playing Different Accompaniment Sections.....	14
Accompaniment Volume.....	15
Chord Fingering.....	15
Tempo.....	16
One Touch Setting.....	16
Metronome.....	16

Mixer.....	17
------------	----

## Other Functions

Tune.....	18
Transpose.....	18
Split Point.....	19
Beat Type.....	19
Beat Volume.....	19
Harmony Switch.....	19
Harmony Type.....	19
Scale Switch.....	21
Scale Type.....	21
Scale Root.....	21
EQ Type.....	21

DSP Effect.....	21
Reverb Type.....	21
Reverb Level.....	21
Chorus Type.....	21
Chorus Level.....	21
MIDI IN.....	21
MIDI OUT.....	22
Touch.....	22
Language.....	22
PowerOff.....	22

## Register Memory

Registering the Panel Setting.....	23
Recalling the Registered Panel Settings.....	23
Selecting a Registration Bank.....	23

## Song Recording

Start Recording.....	24
Stop Recording.....	25
Playback Recording.....	25
Delete User Song.....	25

## Song

Listening to the songs.....	26
Song Control.....	26
Practice the song.....	26

Restore Factory Setting.....	26
------------------------------	----

## Connecting USB Flash Drive

USB Flash Drive Operation.....	27
Play.....	27
Save.....	28
Load.....	28
Delete.....	29
Format.....	29
Keyboard and ASCII Character Relative Table.....	29

## MIDI

What's MIDI?.....	30
MIDI Terminals.....	30
Downloading Data from the Computer.....	30

Troubleshooting.....	31
----------------------	----

Specifications.....	31
---------------------	----

## Appendices

Voice List.....	32
Style List.....	37
Song List.....	39
Chord List.....	41
MIDI Implementation Chart.....	42
Scale Tuning System.....	43

# Panel & Display Description

## Front Panel

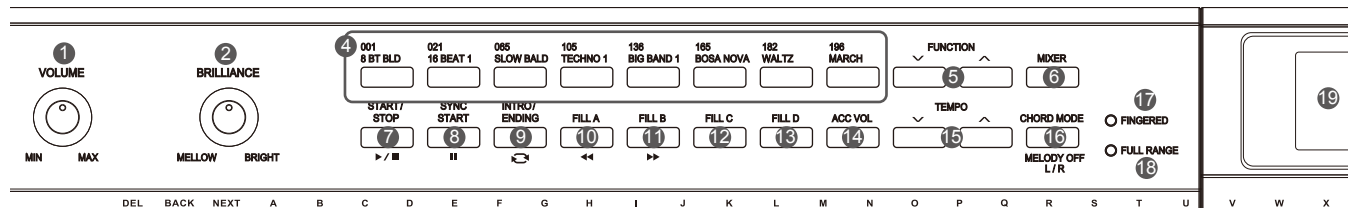

**1. [VOLUME] Knob**  
Adjust master volume

**2. [BRILLIANCE] Knob**  
Adjust voice brilliance

**3. USB device socket**  
Insert a USB flash drive

**12. [FILL C] button**  
A Fill-in C plays

**13. [FILL D] button**  
A Fill-in D plays

**14. [ACC VOL] button**  
Adjust ACCOMP volume

**15. [TEMPO +/-] button**  
Adjust the current tempo

**17. A.B.C. MODE lamp**  
Indicate A.B.C. mode status:  
on or off

**18. FULL RANGE MODE lamp**  
Show if the full range mode is  
on or off

**19. LCD**  
Show all the parameters related  
to the current operation

**39. [POWER] button**  
Turn the power on or off

**When [SHIFT] key pressed**  
**4. Style button**  
Enter the style mode

**When [SHIFT] key released**  
**4. Style direct button**  
Select a direct style

**5. [FUNCTION +/-] button**  
Enter function menu

**6. [MIXER] button**  
Enter mixer menu

**SONG MODE:**  
**7. [START/STOP] button**  
Start or stop playing the song

**8. [PAUSE] button**  
Pause the playing song  
or start it

**9. [REPEAT A/B] button**  
Set the beginning and the  
end for a loop section of a  
selected song

**10. [REW] button**  
Rewind the song

**11. [FF] button**  
Fast forward the song

**16. [MELODY OFF L/R] button**  
Use to mute/activate left or  
right-hand part, allowing each  
part to be practiced separately

**STYLE MODE:**  
**7. [START/STOP] button**  
Start or stop playing the  
style

**8. [SYNC START] button**  
Turn the Sync Start on  
and off

**9. [INTRO/ENDING] button**  
Play the Intro or Ending

**10. [FILL A] button**  
A Fill-in A plays

**11. [FILL B] button**  
A Fill-in B plays

**16. [CHORD MODE] button**  
Choose chord mode

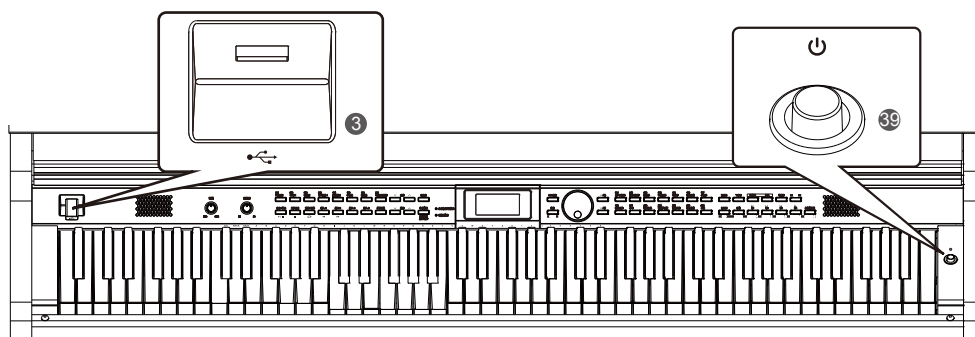

## LCD

**1. Chord display area**  
Display chord information.

**2. Instant message area**  
Display the current tempo, measure, memory/O.T.S setting.

**3. Status display area**  
Display the status of function, USB drive, USB, etc.

**4. System message display area**  
Display important messages related to the current operation.  
I.e. in voice mode, it displays the voice name and number.

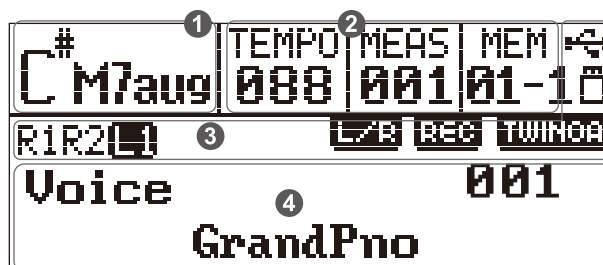

# Panel & Display Description

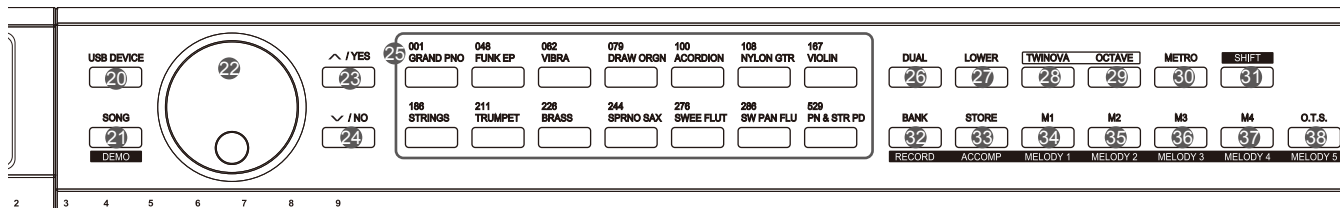

- 20. [USB DEVICE] button**  
Enter USB DEVICE menu
- 22. Data dial**  
Increase and decrease the value
- 23. [+ / YES] button**  
Increase the value
- 24. [- / NO] button**  
Decrease the value
- 26. [DUAL] button**  
Turn the Voice R2 on and off
- 27. [LOWER] button**  
Turn the Voice L1 on and off
- 28. [TWINOVA] button**  
Turn the TWINOVA on and off
- 29. [OCTAVE] button**  
Set octave in TWINOVA mode
- 30. [METRO] button**  
Turn the metronome on and off

**When [SHIFT] key pressed**

- 21. [DEMO] button**  
Enter demo mode and play demo songs
- 25. [VOICE] button**  
Enter the voice mode
- 32. [RECORD] button**  
Enter record mode
- 33. [ACCOMP] button**  
Select the accomp track to record
- 34~38. MELODY 1-5 button**  
Select the melody1-5 track to record

**When [SHIFT] key released**

- 21. [SONG] button**  
Enter song mode and play songs
- 25. Voice direct button**  
Select a direct voice
- 32. [BANK] button**  
Select a bank to store settings
- 33. [STORE] button**  
Register the current panel settings
- 34~37. M1~M4 button**  
Recall the registered panel settings
- 38. [O.T.S.] button**  
Turn one touch setting on and off

- 31. [SHIFT] button**  
Press and hold it to access secondary functions of other buttons

## Pedal

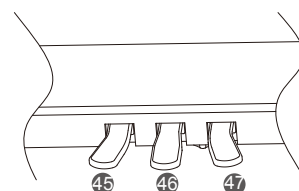

- 45. Soft Pedal**  
When you step on the soft pedal, all notes played on the keyboard will have a softer effect.
- 46. Sostenuto Pedal**  
When you step on the sostenuto pedal, the notes played before you step on the pedal would have a sustain effect.
- 47. Sustain Pedal**  
When you step on the sustain pedal, all notes played on the keyboard will have a longer sustain. It also supports the half-pedal operation. Performing with the sustain pedal will achieve a smoothly effect.

## Rear Panel

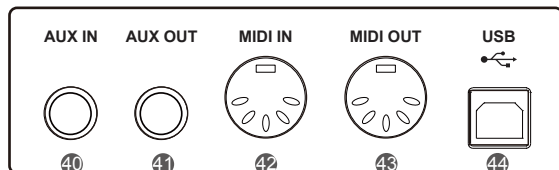

- 40. AUX IN jack**
- 41. AUX OUT jack**
- 42. MIDI IN jack**
- 43. MIDI OUT jack**
- 44. USB jack**

# Setup

This section contains information about setting up your instrument and preparing to play. Please go through this section carefully before turning the power on.

## Setup Guide

Before you proceeding to assemble the stand, get a Philip's screwdriver (not supplied).

Make sure you have the following parts, which are supplied into package.

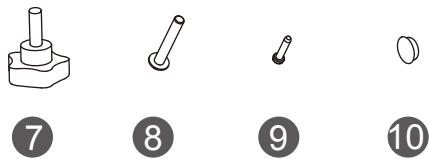
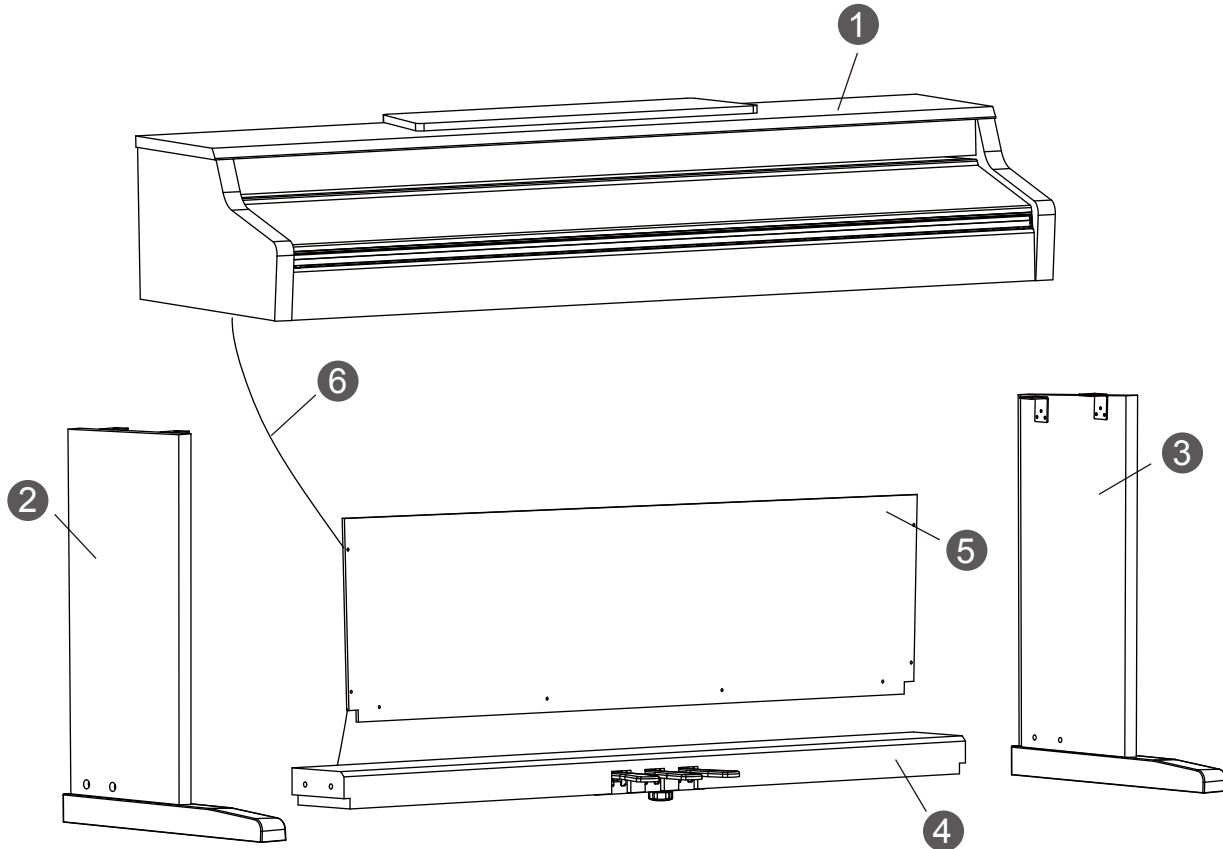

1	Piano body
2	Left leg component
3	Right leg component
4	Foot pedal
5	Rear board
6	Foot pedal cable
7	Hand screws (4pcs)
8	Screws M6x45 (4pcs)
9	Tapping screw 4x15 (8pcs)
10	Screw caps (4pcs)

# Setup

- A.** Put the foot pedal unit (4) in between the left and right leg components (2&3) use 4 pieces of screws (8) (2 on each side) to stable the legs onto the foot pedal unit. (Make sure the direction of the placement is correct before screwing)

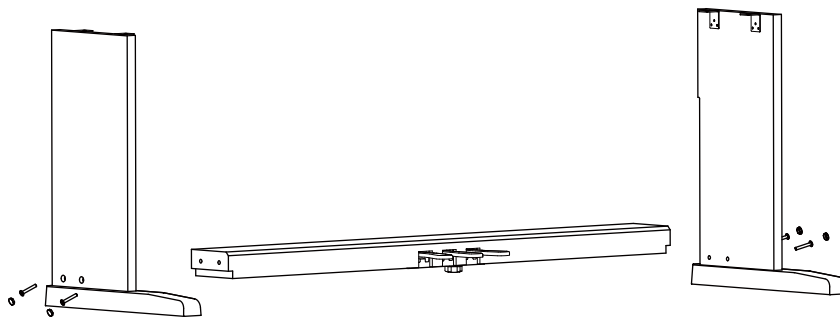

- B.** Use 8 pieces screw (9), make the rear board fixed on the footpedal unit (4) and right leg component (3), the left leg component (2) finished in part B on the previous page.

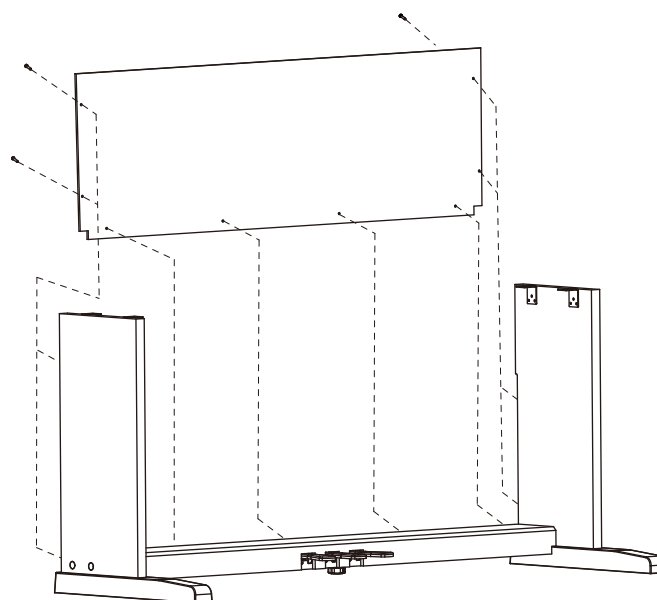

- C.** Put the piano body (1) on the top of the assembly finished in part B, use 4 pieces of hand screws (7) to stable afterward.

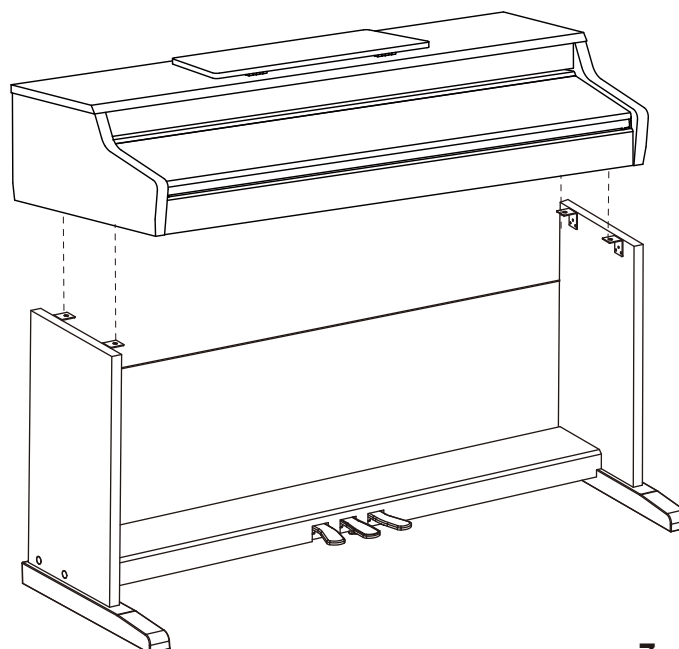

# Setup

D. After the initial set-up, connect pedal cable (6) with the foot pedal to the bottom-panel pedal jack.

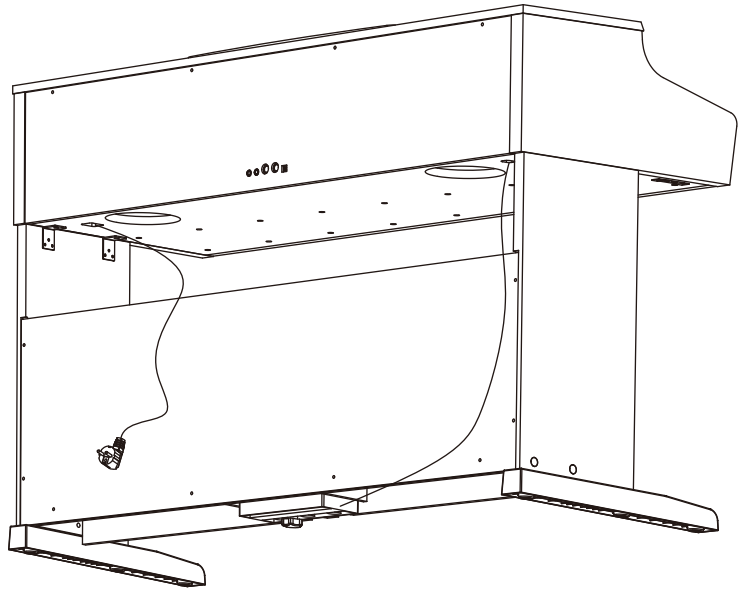

E. Installation is completed now.  
Play the piano and enjoy the perfect performance.

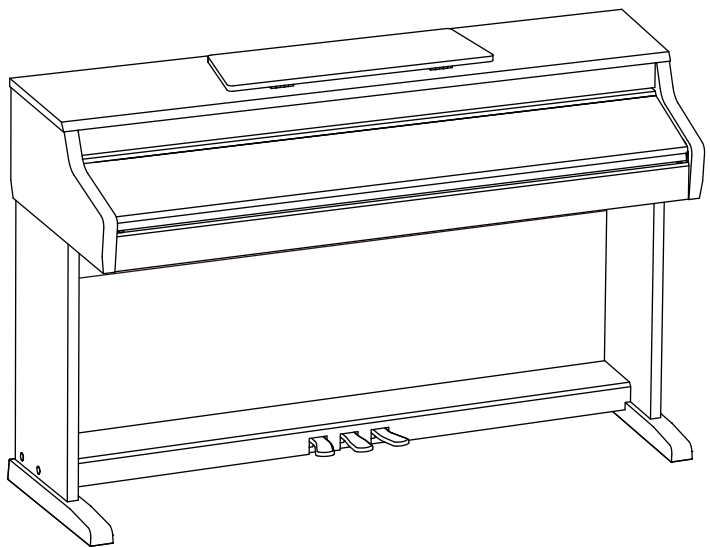



# Connections

## Power Jack

### Power Supply

1. Make sure that the piano is turned off. Before you switch the piano on or off, turn down the volume of piano and any connected audio equipments first.
2. Connect the power cable to the AC outlet.
3. Press the [POWER] button, the LCD will display "LOADING...", which indicates the piano has powered on.
4. If you are ready to turn off the piano, press the [POWER] button again.

### Notes:

1. The piano will be automatically shut down in about 30 minutes if it is not used.
2. When the keyboard is not in use or during thunderstorm, please disconnect the power for safety purpose.

## Connecting a pair of Headphones

A standard pair of stereo headphones can be plugged in here for private practice or late-night playing.

Jack1: when a pair of headphones is plugged into the jack 1, the sound can be heard from both headphones and speakers of the instrument.

Jack2: when a pair of headphones is plugged into the jack 2, the internal stereo speaker system is automatically shut off. The sound can only be heard from headphones.

### Note:

To avoid the risk of hearing loss when using headphones, please do not play the piano with a high volume level for a long time.

## Connecting an Audio Equipment

The rear-panel AUX.OUT jack delivers the output of the instrument for connection to a keyboard amplifier, a mixing console, or tape recorder. Use an audio cord to plug into the AUX.OUT jack located on the rear panel then plug the other end of the cord into AUX.IN of the amplifier.

### Note:

To avoid damaging the speakers, please ensure that the volume has been set to the minimum level before connecting the power and other devices.

## Connecting an MP3/CD Player

Connect the audio output of an MP3/CD player or other audio source to the stereo AUX.IN jack on the rear panel.

The input signal is mixed with the piano signal, allowing you to play along.

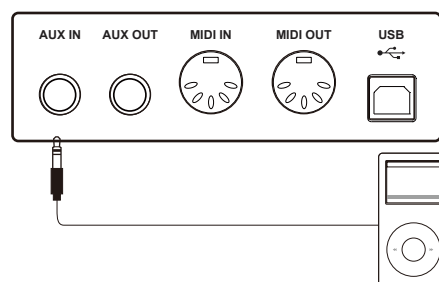
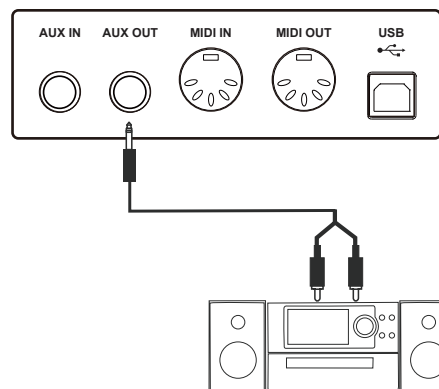
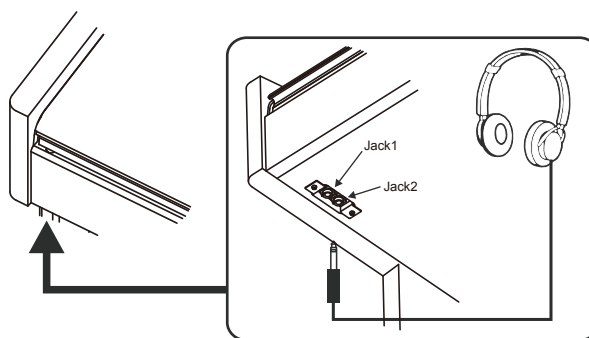
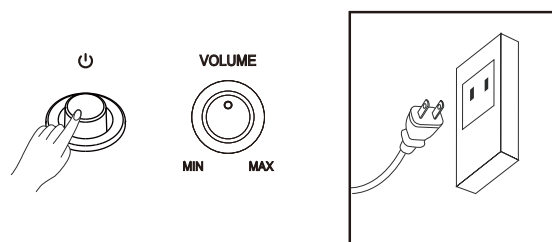

## Connections

### Connecting a Computer

You can use the USB Connector to receive MIDI messages from computer or transmit MIDI messages to computer.

You can use a commercially available MIDI interface to connect the piano to the computer via the MIDI connectors.

**Note:**

Do not set the USB device to be input and output simultaneously when setting the software on PC. Otherwise the sound will be overlapped when playing the keyboard.

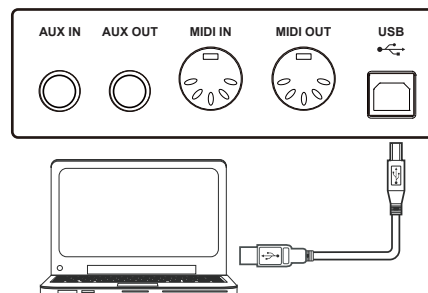

### Connecting external MIDI devices

You can use standard MIDI cables to connect external MIDI devices.

MIDI IN: Receive MIDI message from an external MIDI device.  
 MIDI OUT: Transmits MIDI message generated by the instrument.  
 MIDI THRU: Simply relays the MIDI message received at MIDI IN.

**Note:**

To avoid damages, please be sure to turn off the power switches before you disconnect the related devices from the keyboard.

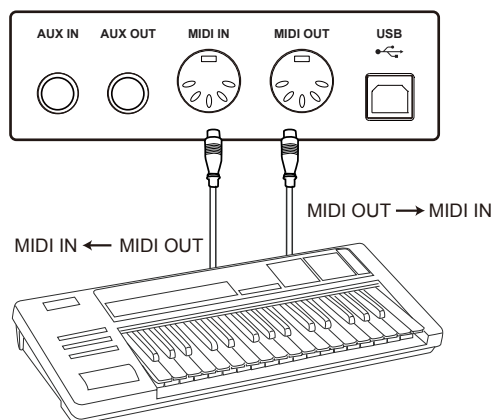

## Adjusting the Master Volume

Rotate the [VOLUME] knob to right, the volume increases and vice versa.



## Adjusting the Voice Brilliance

Slide the [BRILLIANCE] knob to right, the voice sounds brighter and vice versa. You can change the piano brilliance as you wish.

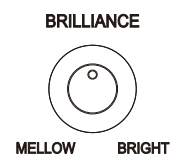

## Playing the Demo Song

The instrument features 5 wonderful demos. Please refer to Demo List.

- Holding down the [SHIFT] button, then press the [DEMO] button to start the demo song playing, and the LCD will display the number and name of the demo.
- Beats Flashing**  
During demo playback, the LED indicator of [START/STOP] will flash with the current tempo, red for strong beat and green for weak beat.
- You can use the data dial, [+ / YES] / [- / NO] button to select a demo song.
- Holding down the [SHIFT] button, then press the [demo] button or press the [START/STOP] button directly to stop playing and exit the demo mode.

### Note:

- In demo mode, only the following button functions will be available: [DEMO], [START/STOP], [TEMPO+/-], [+ / YES], [- / NO], Data dial, [VOLUME], [BRILLIANCE], and [POWER]. All other buttons and the keyboard function will become invalid.
- In recording, style or song mode, the LED indicator of [START/STOP] will flash with the current tempo.

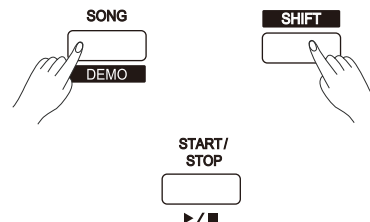

	TEMPO	MEAS	MEM
	130	001	01-1
<b>DEMO</b>			<b>001</b>
	<b>Demo1</b>		

# Playing Voices

The instrument features 600 exceptionally realistic voices. Please refer to Voices List.

## Playing Voices

1. In idle status, holding down the [SHIFT] button, then press one of the voice direct button to enter the voice mode. LCD will display the name and number of the current voice and highlights "R1".
2. Use the data dial, [+ / YES] / [- / NO] button to select the voice you want to play. You can also use the voice direct button to select a voice.
3. You can play the keyboard and listen to the wonderful voice.

### Note:

When the Dual and Lower functions are on, hold down [SHIFT] button, then press one of the voice select buttons to shift the voice source between R1, R2 and L1. The selected one will be highlighted on LCD.

## Playing two voices simultaneously-DUAL

1. In idle mode, press [DUAL] button to turn on dual voice. LCD displays current voice name and number, and highlights "R2".
2. When "R2" is highlighted, use the data dial, the [+ / YES], [- / NO] button or voice direct button to select the dual voice you want to play.
3. Play the keyboard, you will hear two different voices sounded simultaneously in a layer. It seems like two instruments playing at the same time.

### Note:

When the keyboard has been split, only the right hand area will play the dual voice.

## Play Different Voices with Both hands-LOWER

1. In idle mode, press [LOWER] button to turn on lower voice. The keyboard is split into two independent areas, which have different voices. LCD displays the left hand voice name and number, and highlights "L1".
2. When "L1" is highlighted, use the data dial, the [+ / YES], [- / NO] button or voice direct button to select the lower voice you want to play.
3. Play the keyboard with both hands, and you will hear two different voices from the two areas.

### Note:

The right hand voice does not change when you change lower voice.

### Split Point

The Point on the keyboard that separates voice L1 and voice R1/R2 is called the "split point". The split point is set to F#3/G3 at the factory setting. However you can set this to any key you want. Please refer to KeySplit setting for split point.

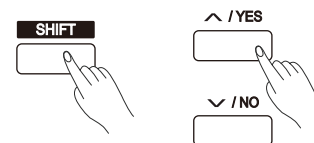
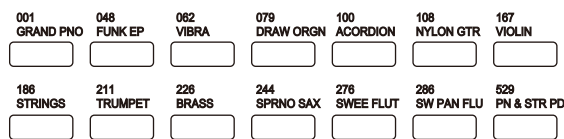

	TEMPO	MEAS	MEM
	096	001	01-1
<b>R1</b>	<b>Voice</b>		<b>001</b>
	<b>GrandPno</b>		

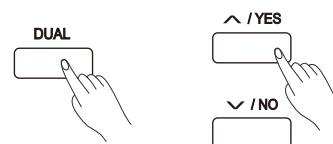

	TEMPO	MEAS	MEM
	096	001	01-1
<b>R1</b> <b>R2</b>	<b>Voice</b>		<b>186</b>
	<b>Strings</b>		

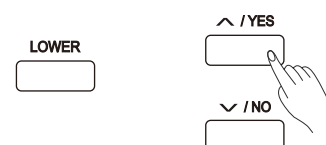

	TEMPO	MEAS	MEM
	096	001	01-1
<b>R1</b> <b>R2</b> <b>L1</b>	<b>Voice</b>		<b>186</b>
	<b>Strings</b>		

# Twinova

The twinova mode splits the keyboard into two independent areas, which have the same pitch and voice, for the convenience of one-to-one teaching.

1. In idle mode, press [TWINOVA] button to turn on twinova. LCD highlights "TWINOVA". In twinova mode, dual voice and lower voice are unavailable. The default split point is E3 (32). Press [TWINOVA] button again you can exit twinova.
2. In twinova mode, the default voice of right hand and left hand is the upper voice you select before entering twinova mode. Use the data dial, the [+ / YES], [- / NO] button or the voice direct button to choose voice.
3. In twinova mode, press [OCTAVE] button, LCD temporarily displays the octave value of twinova. Now you can use the data dial, the [+ / YES], [- / NO] button to set octave value of twinova. The range of octave is -1 to 1.

### Note:

1. In the song playing mode, the twinova is invalid.
2. Please refer to Split Point setting to set the split point.

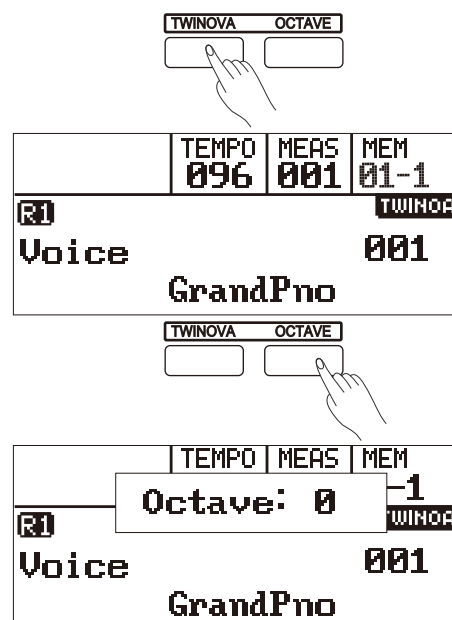

# Auto Accompaniment

The auto accompaniment feature puts a full backing band at your fingertips. To use it, all you have to do is to play the chords with your left hand using your selected accompaniment style, and then the accompaniment will automatically play along, instantly following the chords you play. With auto accompaniment, even a solo performer can enjoy playing with the backing of an entire band or orchestra. This keyboard features 240 (including 10 user styles: 231-240) styles in a variety of musical genres. Try to select some of the different styles (refer to Style List) and enjoy the auto accompaniment.

## Play Auto Accompaniment(rhythm track only)

1. In idle mode, when pressing [SHIFT] button, press any of the style direct button to enter the style mode. LCD displays the name and number of the current style.
2. Use the data dial, the [+ / YES], [- / NO] button or the style direct button to choose style.
3. Press the [START/STOP] button to start the rhythm tracks of the auto accompaniment. Also you can press [SYNC START] and then play any key to start the rhythm tracks of the auto accompaniment.

## Play Auto Accompaniment(all tracks)

1. In style mode, press [CHORD MODE] button to enter "auto bass chord" (A.B.C.) mode. The "FINGERED" LED on the panel will light up. The keyboard is split into two areas. Play chords in the left hand area. Press [CHORD MODE] button again to enter "full range" mode. The "FULL RANGE" LED on the panel will light up. You can play chords over the entire keyboard in normal fingering.

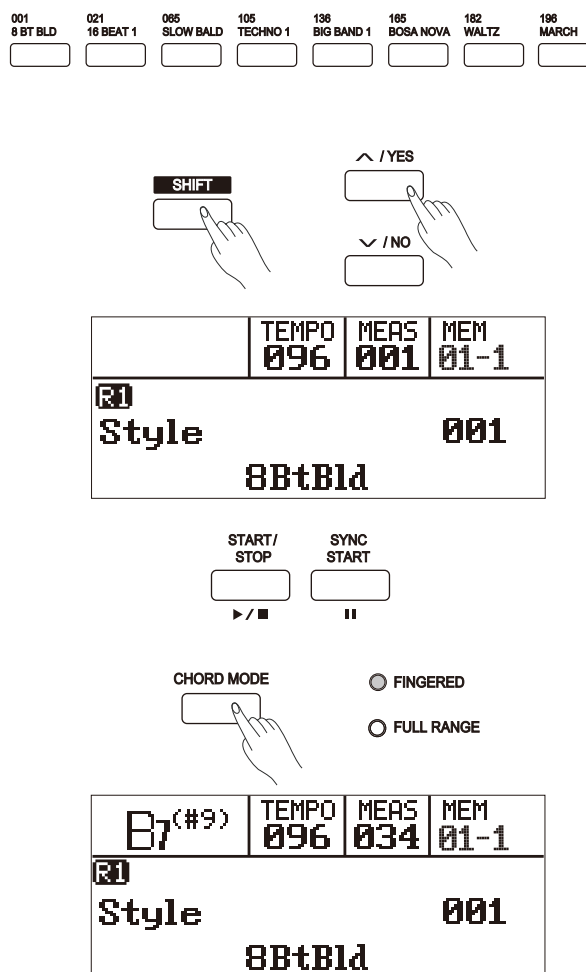

## Auto Accompaniment

2. Press [SYNC START] button, and then play a chord in the chord area to start auto accompaniment of all tracks. When you change a chord, the accompaniment automatically changes.  
Alternatively, press [START/STOP] button to start auto accompaniment of rhythm track, then play a chord in the chord area. It will start auto accompaniment of all tracks

### Accompaniment Sections

There are various types of Auto Accompaniment sections that allow you to vary the arrangement of the accompaniment to match the song you are playing.

They are: Intro, Main (A,B,C,D), Fill (A, B,C,D), and Ending.

By switching among them during your performance you can easily produce the dynamic elements of a professional sounding arrangement in your performance.

#### INTRO Section

The intro is an opening section of the song. When the intro pattern finished, the system will automatically shift to the main section.

#### MAIN Section

The main is an important section of the song. And it plays an accompaniment pattern and repeat infinitely until another section's button is pressed.

#### FILL IN Section

Auto fill in function automatically adds a fill to your performance. When the fill-in is finished, accompaniment shifts to the Main section (A,B,C,D).

#### ENDING Section

Ending is used for the ending of the song. When the ending is finished, accompaniment automatically stops. The length of the ending differs depending on the selected style.

#### Note:

During style playback, hold down one of the FILL [A]-[D] buttons, and the selected fill-in pattern will play continuously until the button is released.

When style stops, press one of the FILL [A]-[D] buttons to select a main section. The corresponding LED will light up.

### Playing Different Accompaniment Sections

1. Press style direct button or use the data dial, [+ / YES] / [- / NO] button to choose style.
2. Press [CHORD MODE] button to enter A.B.C. (auto bass chord) mode.
3. Press [SYNC START] button.
4. Press [FILL A] button.
5. Press the [INTRO/ENDING] button. Now "A" LED flashes on panel, the style is ready to play.
6. It will start the accompaniment as soon as you start playing in Chord section. When the playback of the intro is finished, it automatically leads into Main A section.

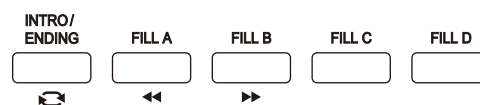
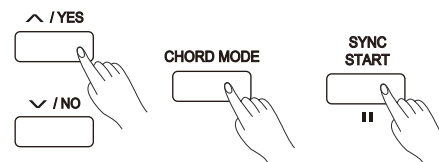
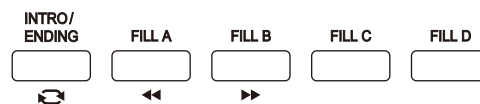

## Auto Accompaniment

- Press the [FILL B] / [FILLDC] / [FILL D] button. A fill-in plays, automatically followed by the Main B/C/D section.
- Press the [INTRO/ENDING] again will lead it into the Ending Section. When the ending is finished, the auto accompaniment automatically stops.

### Accompaniment Volume

This function is used to change the volume of all tracks of accompaniment.

Press [ACC VOL] button, the LCD will display ACCOMP volume (from 0 to 127). At this time, you can use the data dial, or [+ / YES] / [- / NO] button to adjust accomp volume.

### Chord Fingering

How the chords are played or indicated with your left hand (in the auto accompaniment section of the keyboard) is referred to as "fingering". There are 2 types of fingerings as described below.

#### Chord Basics

A chord, in music, is any harmonic set of three or more notes that is heard as if sounding simultaneously. The most frequently encountered chords are triads. A triad is a set of three notes that can be stacked in thirds. When stacked in thirds, the triad's members, from lowest pitched tone to highest, are called: the Root, the Third, and the Fifth.

#### Triad Type

There are following basic triad types:

Major Triad	A root with a major third added above and a perfect fifth will consist as a "Major Triad".
Minor Triad	A root with a minor third added above and a perfect fifth will consist as a "Minor Triad".
Augmented Triad	A root with a major third added above and an augmented fifth will consist as an "Augmented Triad".
Diminished Triad	A root with a minor third added above and a diminished fifth will consist as a "Diminished Triad".

#### Chord Inversion

We define this chord its root is not in the bass (i.e., is not the lowest note) as an inversion chord. When the root is in the bass, we call the chord: root-position chord. If we put the Third and Fifth in the root position, then it forms "Inversion", we call this chord "Inversion Chord". See the following major triad and its inverted chord.

#### Chord Name

The chord name contains two parts content: Chord root and Chord type.

#### Single Finger

Single-finger makes it simple to produce major, seventh, minor and minor seventh chords by pressing a minimum number of keys on the auto accompaniment section.

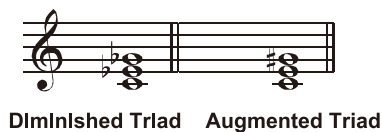
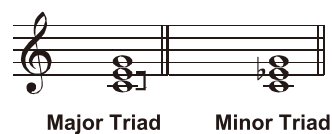
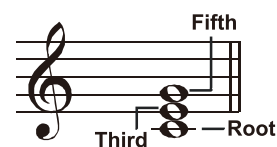

Root Position First Inversion Second Inversion

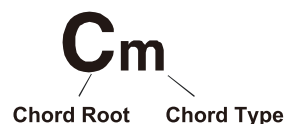

C		<b>★ Major Triad</b> Only press the root note on the keyboard.
C <sub>m</sub>		<b>★ Minor Triad</b> Press the root note and the nearest left black key simultaneously.
C <sub>7</sub>		<b>★ Seventh chord</b> Press the root note and the nearest left white key simultaneously.
C <sub>m7</sub>		<b>★ Minor seventh chord</b> Press the root note and the nearest left white and black keys simultaneously.



# Auto Accompaniment

## Multi-finger

Multi-finger allows you to play chords in normal fingering. Try playing the 32 chord types in C scale as listed on the right.

### Note:

In full range mode, the entire keyboard will only recognize chords played in normal fingering.

## Tempo

Each style of the instrument has been set with a default or standard tempo, however, this can be changed by using the [TEMPO+]/[TEMPO-] buttons.

1. Use the [TEMPO+] or [TEMPO-] button to change the tempo. While the tempo data is flashing, use the data dial also can change the tempo.
2. Press the [TEMPO+]/[TEMPO-] buttons simultaneously to restore the default tempo setting.

## One Touch Setting

When One Touch Setting is switched on, you can instantly recall all auto accompaniment related settings including voices selection and digital effects simply with a single touch of a button.

1. Press the [O.T.S.] button to turn on the One Touch Setting for current style.
2. Press one of the one touch setting buttons [M1]-[M4]. Various panel settings (such as voice, effect, etc.) that match the selected style can be instantly recalled with just a single button press. Auto accompaniment is automatically turned on during O.T.S. mode.
3. Play the keyboard.
  - One Touch Setting parameter list:
  - Part ON/OFF (VOICER1, R2, L1)
  - Voice Change (VOICER1, R2, L1)
  - Voice Volume (VOICER1, R2, L1)
  - Voice Reverb Level (VOICER1, R2, L1)
  - Voice Chorus Level (VOICER1, R2, L1)

## Metronome

Using metronome helps you with beat that guides your playing by preset tempo.

1. Turn on the metronome  
Press the [METRO] button to turn the metronome on.
2. Turn off the metronome  
Press the [METRO] button again to turn the metronome off.
3. Metronome beat type setting  
Please refer to beat type setting.

### Note:

The metronome will respond in the next beat if it is turn on when the accompaniment is playing.

When recording, metronome beats cannot be recorded.

0 C	1 C <sub>6</sub>	2 C <sub>M7</sub>	3 C <sub>M7</sub> (#11)	4 C <sub>M</sub> (9)	5 C <sub>M7</sub> ( <sup>9</sup> )
6 C <sub>6</sub> ( <sup>9</sup> )	7 C <sub>aug</sub>	8 C <sub>m</sub>	9 C <sub>m6</sub>	10 C <sub>m7</sub>	11 C <sub>m7</sub> ( <sup>b5</sup> )
12 C <sub>m</sub> (9)	13 C <sub>m7</sub> ( <sup>9</sup> )	14 C <sub>m7</sub> ( <sup>11</sup> )	15 C <sub>mM7</sub>	16 C <sub>mM7</sub> ( <sup>9</sup> )	17 C <sub>dim</sub>
18 C <sub>dim7</sub>	19 C <sub>7</sub>	20 C <sub>7sus4</sub>	21 C <sub>7</sub> ( <sup>b5</sup> )	22 C <sub>7</sub> ( <sup>9</sup> )	23 C <sub>7</sub> ( <sup>#11</sup> )
24 C <sub>7</sub> ( <sup>13</sup> )	25 C <sub>7</sub> ( <sup>b9</sup> )	26 C <sub>7</sub> ( <sup>b13</sup> )	27 C <sub>7</sub> ( <sup>#9</sup> )	28 C <sub>M7aug</sub>	29 C <sub>7aug</sub>
30 C <sub>sus4</sub>	31 C <sub>1+2+5</sub>	Notes enclosed in parentheses are optional; the chords could be recognized without them.			

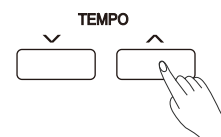

	TEMPO	MEAS	MEM
	096	001	01-1
[M1]	Style		001
	8BtB1d		



	TEMPO	MEAS	O.T.S.
	096	001	1
[M2]	Voice		030
	DetunEP		





# Mixer

Mixer function adjusts separately the volume of different tracks.

1. Press the [MIXER] button.

Now you have entered the menu of mixer. Press the [MIXER] button repeatedly to select a track to change its volume.

2. To adjust the selected volume setting, please use the data dial or the [+ / YES] / [- / NO] button.

Press [+ / YES] and [- / NO] button simultaneously to turn off a track volume.

Press [+ / YES] and [- / NO] button simultaneously again to turn on a track volume.

The option and parameters are as follows:

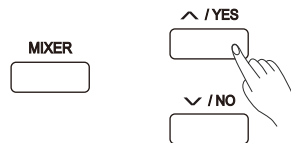

	TEMPO	MEAS	MEM
	096	001	01-1
<b>MixerSet</b> Rhythm_m Vol: 108			

Option	LCD display	Range
Rhythm slave volume	Slave Rhythm: xxx	0 - 127
Rhythm master volume	Master Rhythm: xxx	0 - 127
Bass volume	Bass: xxx	0 - 127
Chord 1 volume	Chord1: xxx	0 - 127
Chord 2 volume	Chord2: xxx	0 - 127
Chord 3 volume	Chord3: xxx	0 - 127
Phrase 1 volume	Phrase1: xxx	0 - 127
Phrase 2 volume	Phrase2: xxx	0 - 127
Voice R1 volume	Upper1: xxx	0 - 127
Voice R2 volume	Upper2: xxx	0 - 127
Voice L volume	Lower: xxx	0 - 127
Disk volume	Disk Vol: xxx	0 - 127

# Other Functions

Press [FUNCTION+/-] button to enter function menu. The default option of the menu is "Tune". When you enter the menu next time, you will find the option is the same as last time. Use [FUNCTION+/-] button to select the option to set. Use [+YES]/[-NO] or data dial to set parameter of the current menu.

The option and parameters are as follows:

No.	Option	Range	Default
1	Tune	-50~+50	+00
2	Transpose	-12~+12	+00
3	Split Point	1~88	034
4	Beat Type	0, 2~9	004
5	Beat Volume	0~127	090
6	Harmony Switch	OFF, ON	OFF
7	Harmony Type	Duet, 1+5, Octave, CtryDuet, Trio, Block, 4Close1, 4Close2, 4Open	Duet
8	Scale Switch	OFF, ON	OFF
9	Scale type	Pythagor, Major, Minor, MeanTone, Werckmei, Kirnberg	Pythagor
10	Scale Root	C, C#, D, D#, E, F, F#, G, G#, A, A#, B	C
11	EQ type	Reset, Pop, Rock, Class, Jazz, Dance	Reset
12	DSP Effect	OFF, ON	ON
13	Reverb Type	Room1, Room2, Room3, Hall1, Hall2, Church, Delay, PanDelay	Hall2
14	Reverb Level	0~127	070
15	Chorus Type	Chorus1, Chorus2, GM Chrs1, GM Chrs2, Flanger1, Flanger2, Rotary1, Rotary2	Chorus1
16	Chorus Level	0~127	000
17	MIDI IN	1~16, ALL	ALL
18	MIDI OUT	1~16	001
19	Touch	OFF, 1, 2, 3	002
20	Language	中文, English	English
21	Power Off	OFF, 30, 60	030

## Tune

This function sets the pitch of entire keyboard in 2-cent increments.

1. Press [FUNCTION+/-] button to select tune menu. LCD displays "Tune: xxx". Use [+YES]/[-NO] or data dial to change tune value. Its range is from -50 to 50.

2. Press [+YES] and [-NO] simultaneously will set the tune value to its default setting:000.

## Transpose

Transpose function allows the overall pitch of the instrument to be transposed up or down by a maximum of one octave in semitone steps.

1. Press [FUNCTION+/-] button to select transpose menu. LCD displays "Transpose: xxx". Use [+YES]/[-NO] or data dial to change transpose value. The max transpose is  $\pm 12$  semitones.

2. Press [+YES]/[-NO] simultaneously will set the transpose value to its default setting:000.

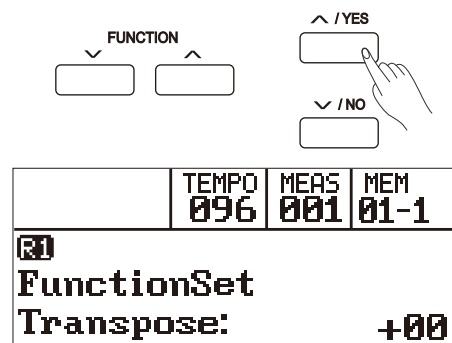
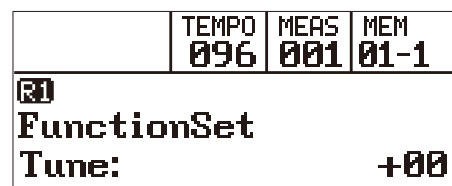
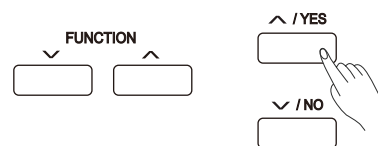
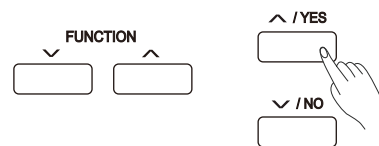

## Other Functions

### SplitPoint

This function sets the point that separates the entire keyboard to two sections.

1. Press [FUNCTION+/-] button to select SplitPoint menu. LCD displays "SplitPt: xxx". Use [+ /YES] / [- /NO] or data dial to change SplitPoint value. The range of keysplit: 1~88.
2. Press [+ /YES] and [- /NO] simultaneously will set the SplitPoint value to its default setting: F#3(34).

#### Note:

When twinova is on, the range of keysplit is C3~C6(28~64). Press [+ /YES] and [- /NO] simultaneously will set the SplitPoint value to its default setting: E3(32).

### Beat Type

1. Press [FUNCTION+/-] button to select BeatType menu. LCD displays "BeatType: xxx". Use [+ /YES] / [- /NO] or data dial to change beat type. The range of beat type: 0, 2~9.
2. Press [+ /YES] and [- /NO] simultaneously will set the beat type value to its default setting: 4.

### Beat Volume

1. Press [FUNCTION+/-] button to select beat volume menu. LCD displays "BeatVol: xxx". Use [+ /YES] / [- /NO] or data dial to change beat volume. The range of beat volume: 0~127.
2. Press [+ /YES] and [- /NO] simultaneously will set the beat volume value to its default setting: 090.

### Harmony Switch

1. Press [FUNCTION+/-] button to select harmony switch menu. LCD displays "HarmonySw: xxx". Use [+ /YES] / [- /NO] or data dial to change harmony switch status: OFF, ON.
2. Press [+ /YES] and [- /NO] simultaneously will set harmony switch to default setting: OFF.

#### Playing with harmony:

Turn on the A.B.C function, then play a chord in the left hand area. When you play in the right hand area, it will automatically add a harmony effect to the notes.

Harmony types "1+5" and "octave" are always available, while the rest are effective only when A.B.C is on.

### Harmony Type

You can add a variety of harmony notes to the keys you played in the right-hand section.

1. Press [FUNCTION+/-] button to select harmony type menu. LCD displays "HarmonyTp: xxx". Use [+ /YES] / [- /NO] or data dial to change harmony type.

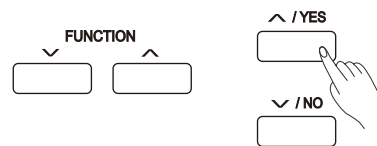

	TEMPO	MEAS	MEM
	096	001	01-1
<b>FunctionSet</b>			
<b>SplitPt:</b>			<b>034</b>

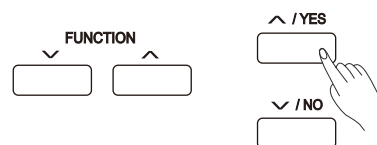

	TEMPO	MEAS	MEM
	096	001	01-1
<b>FunctionSet</b>			
<b>BeatType:</b>			<b>004</b>

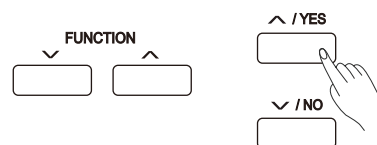

	TEMPO	MEAS	MEM
	096	001	01-1
<b>FunctionSet</b>			
<b>BeatVol:</b>			<b>090</b>

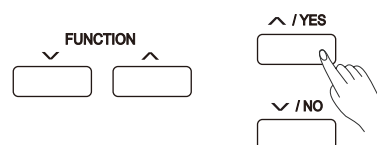

	TEMPO	MEAS	MEM
	096	001	01-1
<b>FunctionSet</b>			
<b>HarmonySw:</b>			<b>OFF</b>

	TEMPO	MEAS	MEM
	096	001	01-1
<b>FunctionSet</b>			
<b>HarmonyTp:</b>			<b>Duet</b>

## Other Functions

There are 9 harmony types built into this instrument.

Parameter	LCD Display
Duet	Duet
1+5	1+5
Octave	Octave
Country Duet	CtryDuet
Trio	Trio
Block	Block
4 Close 1	4Close1
4 Close 2	4Close2
4 Open	4Open

- Press [+ / YES] and [- / NO] simultaneously will set harmony type to default setting: Duet.

### Scale Switch

The equal temperament (has only one tuning method, and is suitable for keyboard instrument) is commonly used in modern music, based on this temperament method to make your own composition and performance. Especially for piano, equal temperament is widely used and taken for granted. But people used several other scales to compose and perform before adopting the equal temperament.

- Press [FUNCTION+/-] button to select scale switch menu. LCD displays "ScaleSw: xxx". Use [+ / YES] / [- / NO] or data dial to change Scale switch status: OFF, ON.
- Press [+ / YES] and [- / NO] simultaneously will set scale switch to default setting: OFF.

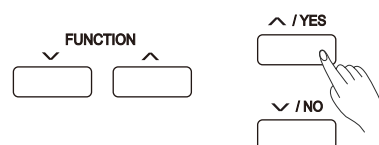

	TEMPO	MEAS	MEM
	096	001	01-1
<b>[F]</b>	<b>FunctionSet</b>		
	<b>ScaleSu:</b>		<b>OFF</b>

### Scale Type

- Press [FUNCTION+/-] button to select scale type menu. LCD displays "ScaleType: xxx". Use [+ / YES] / [- / NO] or data dial to change scale type. There are 6 scale types built into this instrument.

Parameter	LCD Display
Pythagorean	Pythagor
Pure Major	Major
Pure Minor	Minor
Meantone	MeanTone
Werkmeister	Werckmei
Kirnberger	Kirnberg

- Press [+ / YES] and [- / NO] simultaneously will set scale type to default setting: Pythagor.

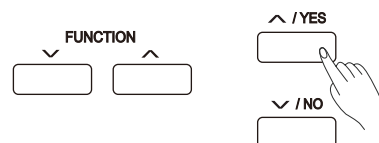

	TEMPO	MEAS	MEM
	096	001	01-1
<b>[F]</b>	<b>FunctionSet</b>		
	<b>ScaleType:</b>		<b>Pythagor</b>

### Scale Root

- Press [FUNCTION+/-] button to select scale root menu. LCD displays "ScaleRoot: xxx". Use [+ / YES] / [- / NO] or data dial to change scale root: C, C#, D, D#, E, F, F#, G, G#, A, A#, B.
- Press [+ / YES] and [- / NO] simultaneously will set scale root to default setting: C.

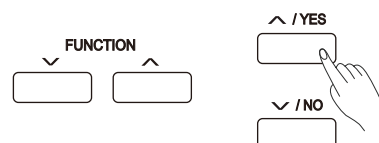

	TEMPO	MEAS	MEM
	096	001	01-1
<b>[F]</b>	<b>FunctionSet</b>		
	<b>ScaleRoot</b>		<b>C</b>

## Other Functions

### EQ Type

EQ function can control the gain of different frequency band. And different gain settings produce different sound field effects.

1. Press [FUNCTION+/-] button to select EQ type menu.  
LCD displays "EqType: xxx". Use [+ /YES] / [- /NO] or data dial to change EQ type.  
There are 6 EQ types built into this instrument.

Parameter	LCD Display
Reset	Reset
Pop	Pop
Rock	Rock
Class	Class
Jazz	Jazz
Dance	Dance

2. Press [+ /YES] and [- /NO] simultaneously will set EQ type to default setting: Reset.

### DSP Effect

1. Press [FUNCTION+/-] button to select DSP effect menu. LCD displays "DspEffect: xxx". Use [+ /YES] / [- /NO] or data dial to change DSP switch status: OFF, ON.
2. Press [+ /YES] and [- /NO] simultaneously will set DSP switch to default setting: ON.

### Reverb Type

1. Press [FUNCTION+/-] button to select reverb type menu.  
LCD displays "ReverbType: xxx". Use [+ /YES] / [- /NO] or data dial to change reverb type.  
There are 8 reverb types built into this instrument.

Parameter	LCD Display
Room 1	Room1
Room 2	Room2
Room 3	Room3
Hall 1	Hall1
Hall 2	Hall2
Church	Church
Delay	Delay
Pan Delay	PanDelay

2. Press [+ /YES] and [- /NO] simultaneously will set reverb type to default setting: Hall2.

### Reverb Level

1. Press [FUNCTION+/-] button to select reverb level menu.  
LCD displays "ReverbLev: xxx". Use [+ /YES] / [- /NO] or data dial to change reverb level.  
The range of reverb level: 0~127.

2. Press [+ /YES] and [- /NO] simultaneously will set reverb level to default: 070.

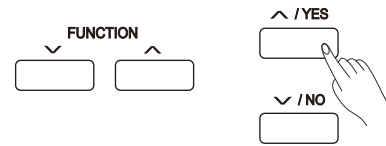

	TEMPO	MEAS	MEM
	096	001	01-1
<b>[F1]</b>	<b>FunctionSet</b>		
	<b>EqType:</b>		<b>Reset</b>

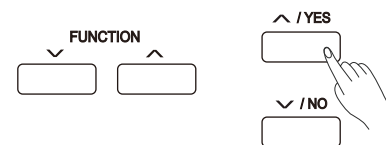

	TEMPO	MEAS	MEM
	096	001	01-1
<b>[F1]</b>	<b>FunctionSet</b>		
	<b>DspEffect:</b>		<b>ON</b>

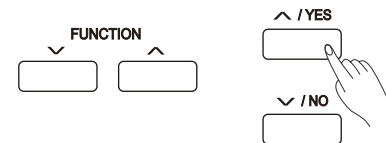

	TEMPO	MEAS	MEM
	096	001	01-1
<b>[F1]</b>	<b>FunctionSet</b>		
	<b>ReverbType:</b>		<b>Hall2</b>

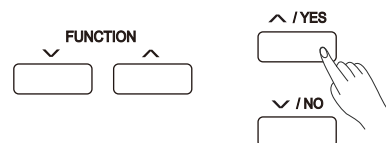

	TEMPO	MEAS	MEM
	096	001	01-1
<b>[F1]</b>	<b>FunctionSet</b>		
	<b>ReverbLev:</b>		<b>070</b>

## Other Functions

### Chorus Type

- Press [FUNCTION+/-] button to select chorus type menu. LCD displays "ChorusType: xxx". Use [+ /YES] / [- /NO] or data dial to change chorus type. There are 8 chorus types built into this instrument.

Parameter	LCD Display
Chorus 1	Chorus1
Chorus 2	Chorus2
GM Chorus 1	GM Chrs1
GM Chorus 2	GM Chrs2
Flanger 1	Flanger1
Flanger 2	Flanger2
Rotary 1	Rotary1
Rotary 2	Rotary2

- Press [+ /YES] and [- /NO] simultaneously will set chorus type to default setting: Chorus1.

### Chorus Level

- Press [FUNCTION+/-] button to select chorus level menu. LCD displays "ChorusLev: xxx". Use [+ /YES] / [- /NO] or data dial to change chorus level. The range of chorus level: 0~127.

- Press [+ /YES] and [- /NO] simultaneously will set chorus level to default: 000.

### MIDI IN

- Press [FUNCTION+/-] button to select MIDI IN menu. LCD displays "MidiIn: xxx". Use [+ /YES] / [- /NO] or data dial to change MIDI IN channel: 1~16, ALL.

- Press [+ /YES] and [- /NO] simultaneously will set MIDI IN channel to default setting: ALL.

### MIDI OUT

- Press [FUNCTION+/-] button to select MIDI OUT menu. LCD displays "MidiOut: xxx". Use [+ /YES] / [- /NO] or data dial to change MIDI OUT channel: 1~16.

- Press [+ /YES] and [- /NO] simultaneously will set MIDI OUT channel to default setting: 001.

### Touch

The keyboard is equipped with a touch response feature that lets you dynamically and expressively controls the level of the voice with your playing strength just as on an acoustic instrument.

- Press [FUNCTION+/-] button to select touch menu. LCD displays "Touch: xxx". Use [+ /YES] / [- /NO] or data dial to change touch type: OFF, 1(soft), 2(normal), 3(hard).
- Press [+ /YES] and [- /NO] simultaneously will set touch value to default setting: 2(normal).

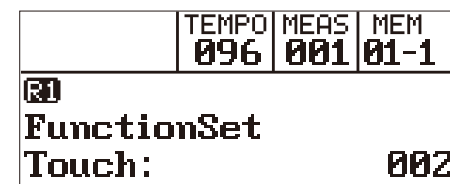
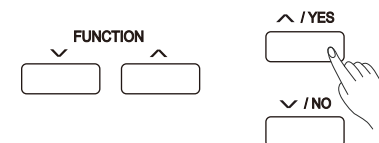
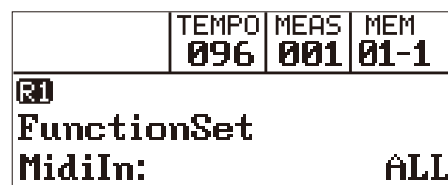
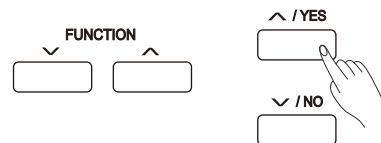
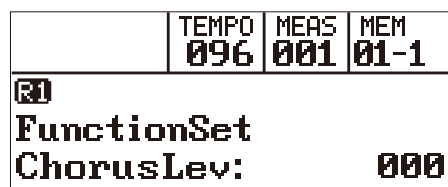
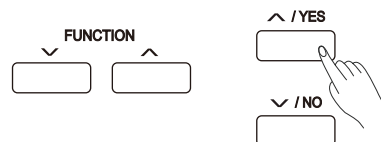
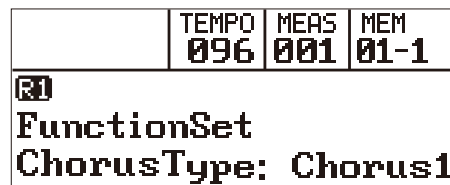
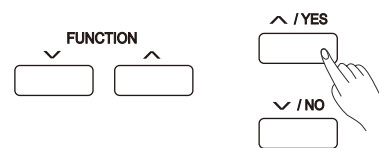

## Other Functions

### Language

This function is used to set the system language.

1. Press [FUNCTION+/-] button to select language menu. LCD displays "Language: xxx". Use [+ /YES] / [- /NO] or data dial to change language: 中文, English
2. The language setting will not be lost after power off.

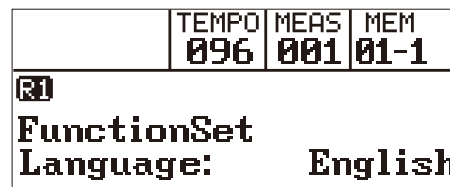
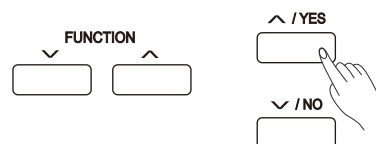

### PowerOff

This function is used to set the time of automatic shutdown.

1. Press [FUNCTION+/-] button to select power off menu. LCD displays "PowerOff: xxx". Use [+ /YES] / [- /NO] or data dial to change time value: OFF, 030, 060
2. Press [+ /YES] and [- /NO] simultaneously, the time will be restore default: 030 minutes

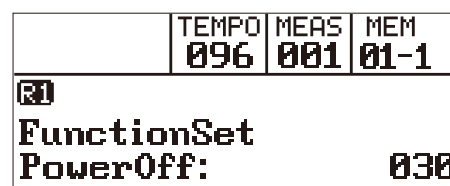
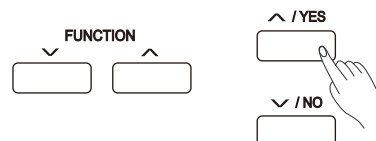

## Register Memory

The keyboard is an instrument with a variety of controls and functions, the Registration Memory feature can make your performance more easily and efficiently. It allows you to save virtually all panel settings to a Registration Memory setting, and you can instantly recall custom panel settings by pressing a single button.

### Registering the Panel Setting

1. There are 24 memory banks, each bank has 4 memories (M1-M4).
2. While holding the [STORE] button, press one of the REGISTRATION MEMORY buttons: [M1] - [M4]. Notice that the new settings will replace the previous memory data.

### Recalling the Registered Panel Settings

Press one of the MEMORY buttons [M1] - [M4] to recall a panel setting.

For example, press [M3] and LCD shows "01-3". It will recall a setting from memory 3 of bank 1.

#### Note:

Registration data cannot be recalled when the One Touch Setting function is on.

### Selecting a Registration Bank

1. Press the [BANK] button. There are 24 banks at all and each bank has 4 memories(M1-M4). Press the [BANK] button, the LCD displays "MemBank".
2. Select a bank. Use the data Dial, [+ /YES] or [- /NO] button to select a bank from 1 to 24.



# Song Recording

With the easy-to-use song recording features, you can record your own keyboard performances as a user song. 10 user songs can be recorded with 6 tracks (1 ACCOMP track, 5 MELODY tracks) each. The accomp track records the accompaniment for a user song, while the melody tracks record melodies for a user song.

An accomp track and a melody track can be recorded independently or together, however, you can not record two melody tracks at the same time.

You can play back the accomp track and melody tracks together. The saved data will not be lost after power off.

## Start Recording

Before recording starts, you will need to select a user song to which your recording will be saved.

1. Holding down [SHIFT] button, then press [RECORD] button to enter the user song selection interface. The LCD displays "RecSong1" and sequence number. 10 user songs can be recorded. Press [+ / YES] / [- / NO] button to select the user song you want.
2. Hold down [SHIFT] button, then press [RECORD] button again to enter the recording standby mode. "REC" appears on LCD, and the [START/STOP] LED on the panel lights up. It will automatically select an empty track to record your performance. LED of the selected track (ACCOMP, MELODY1 - MELODY 5) will flash on the panel.
3. In recording standby mode, you can select your desired voice, style and tempo. Hold down [SHIFT] button, then Press [Accomp] or [Melody1] - [Melody 5] to select a different track. LED of the selected track will light up on the panel. An accomp track and a MELODY track can be recorded together, but it cannot record two melody tracks simultaneously.
4. Press [START/STOP] button or play the keyboard to start recording. The [RECORD] LED will light up. When the accomp track is selected and A.B.C is on, recording will start as soon as you play a chord in the left hand area.

### Note:

Style can only be recorded in "Accomp" track.

Track indicators on the left of LCD usually shows one of three states: blinking, light up, light off. Press the track buttons repeatedly to shift between different states.

**Blinking:** the track is selected for recording. All existing data will be over-written.

**Light up:** the track has data and will play back the data during recording.

**Light off:** the track either has no data or is under recording and cannot play back.

In recording standby mode, the keyboard will automatically select the empty track next to the occupied track. For example, if "Melody 1" is occupied, "Melody 2" will be selected as the record track. When all 6 tracks have been recorded and a specific track needs to be revised, press the button of that track and start recording. The original data will be replaced.

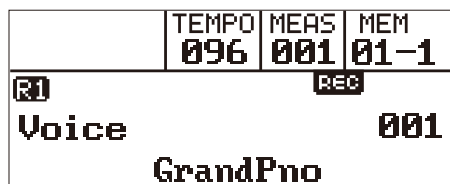
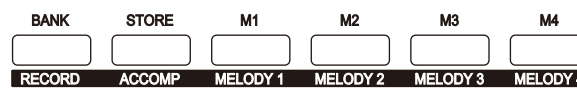
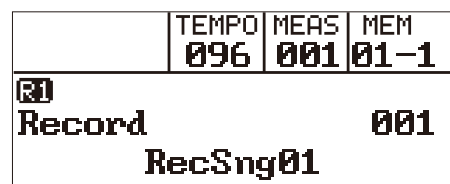



## Song Recording

### Stop Recording

1. When recording is in process, holding down [SHIFT] button then press the [RECORD] button to stop recording.
2. When recording is in process, if the memory is full, the recording will stop and save automatically, the LCD displays "RecFull".
3. If you are recording a style, the recording will stop automatically when the ending of the rhythm finishes.

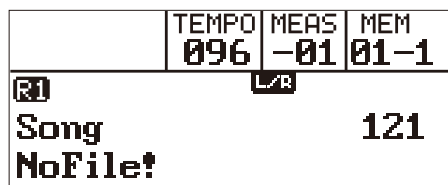

### Playback Recording

1. When recording is in process, holding down [STORE] button then press the [RECORD] button, it will stop recording and enter the song mode, and the current recorded song will play automatically in circle.
2. Press the [SONG] button to enter the song mode and it will play all songs circularly. Use the data dial, [+ / YES] or [- / NO] button to select a song, there are 130 songs in all, including 10 user songs (121-130). If there is no data in the selected user song, it will display "Nofile" and stop playing. Alternatively, when the playback stops, you can select a user song and then press [PLAY/STOP] button to play the song in a loop.

### Delete User Song

1. Pressing and holding [RECORD] and [STORE] button together and turn power on simultaneously, all user songs will be erased.
2. In the recording standby mode, holding down [SHIFT] button then press the [RECORD] button for two second, the LCD will display "Delete?". And holding down [SHIFT] button then press the [Accomp] (or [Melody1] to [Melody 5]) button to select the track you want to delete. The track selected will light up. If all tracks light up, it will delete the user song after confirmation.
3. Press [+ / YES] to confirm and the recorded data in this track will be erased. Press [- / NO] to quit this step, and go back to recording standby mode.



# Song

The piano has 130 songs in all, including 10 user songs.

## Listening to the songs

1. Press the [SONG] button to enter the song mode and it will play all songs circularly.
2. Use the data dial, [+ /YES] or [- /NO] button to select a song.
3. Once you start playing a song by pressing [START/STOP] button, it will play current song repeatedly.
4. When playback stops, press [STYLE] or [VOICE] button to exit song mode.

## Song Control

1. Introductory beat  
Before song starts playing, it has the introductory beat, the measure starts from negative value. It begins to play song when the measure goes to 1.
2. REW, FF and PAUSE  
When the song is playing:  
Press the [FF] button to fast forward the song.  
Press the [REW] button to rewind the song (base on the measure).  
Press the [PAUSE] button to pause the playing song.
3. Song Repeat  
During song playback, press [REPEAT A/B] button to set the beginning for a loop section of the current song, then press it again to set the loop end. During loop playback, press [REPEAT A/B] button to quit the loop and go back to song playback.

## Practice the song

In song mode, press [MELODY OFF L/R] button to turn on/off the left or right hand part, so as to practise each part separately. A lit "L" on LCD indicates only the left hand melody will play and the right hand part will be muted, so you can practise the right hand melody.

In the same way, a lit "R" on LCD means you can practise the left hand part along with the right hand melody.

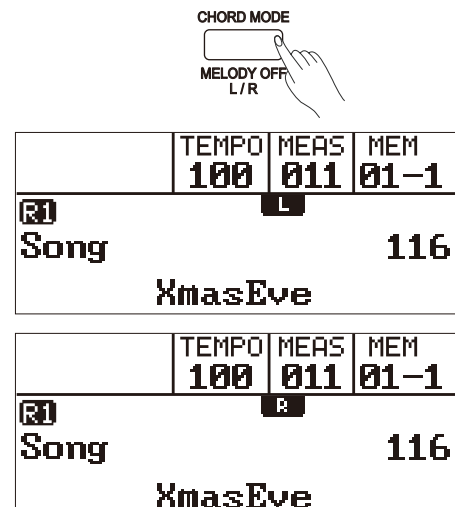
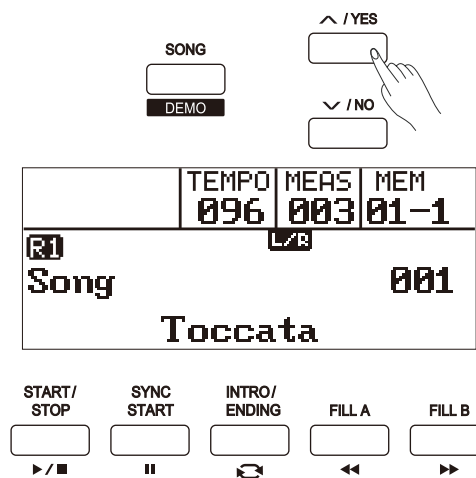

# Restore Factory Setting

Pressing and holding [+ /YES] and [- /NO] button together and then turn the power on, the piano would be restored to factory setting. It will delete all the user data: user styles, user songs, registered memory. The process will last about 8 seconds, after which the piano will start up normally.







# Connecting USB Flash Drive

The piano recognizes USB flash drives, sizing from 16M to 32G in the format of FAT16 or FAT32.

We recommend to format the USB flash drive on the piano before using. Do not edit the backup files saved in the USB flash drive.

## USB Flash Drive Operation

- The function buttons related to USB Flash Drive are: [USB DEVICE], [+ / YES], [- / NO], [START / STOP] and the data dial.
- Press [USB DEVICE] button to enter USB mode, and press it again can quit that mode.
- If the USB Flash Drive has been inserted before pressing [USB DEVICE] button, the LCD displays a waiting notice, the upper right corner of LCD displays icon . If initialization succeeds, LCD displays "Play", the icon becomes . If initialization failed, the LCD displays "DiskErr", and the icon remains . If USB Flash Drive is not inserted, the LCD displays "NoDisk", the upper right corner of LCD does not display USB Flash Drive icon.
- In USB mode, use data dial to select menu, press [+ / YES] button to proceed, press [- / NO] to go back.
- In USB mode, it can read a maximum of 512 files in one folder. Icon  represents folder, icon  represents file.
- In USB mode, press [USB DEVICE], voice direct button, style direct button can exit USB device mode.
- Press [MIXER] button can change the volume when playing MIDI file.
- Loading, Save and Delete operating are intended for the file in "MMKD" folder.

### Note:

The "MMKD" folder will be generated automatically when user data is saved to the USB flash drive.

## Play

- Press [USB DEVICE] button to enter USB mode. Then use data dial to select "Play" menu.
- Press [+ / YES] button, LCD will display the name of MIDI files and sub directories in the root of the USB Flash Drive.
- If you choose a sub-directory, press [+ / YES] button to open the folder, press [- / NO] to return to the root directory. If LCD displays "..", pressing [+ / YES] button will return to the previous directory.
- Use data dial to select a midi MIDI file, press [START / STOP] button to play it repeatedly. Press [+ / YES] button to play all files in the current directory circularly. Press [START / STOP] button again to stop playing,

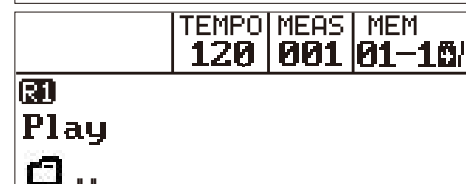
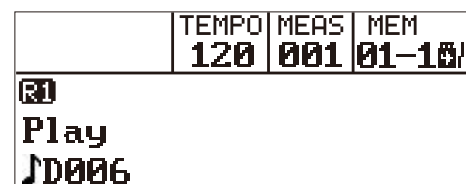
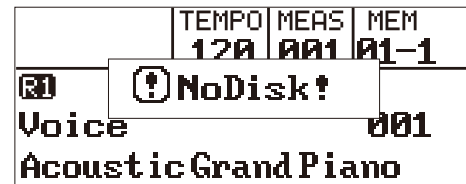
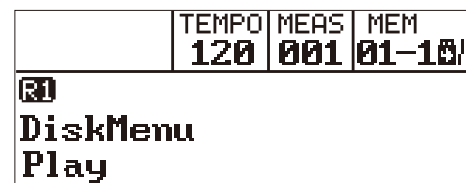
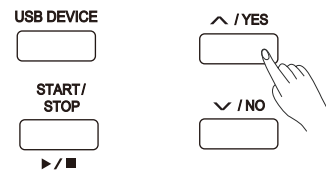

## Connecting USB Flash Drive

### Save

1. Press [USB DEVICE] button to enter USB mode. Then use data dial to select "Save".
2. Press [+ / YES] to enter "Save" sub menu. It includes "SaveSong", "SaveSty", "SaveMem". Use [+ / YES], [- / NO] button or data dial to select one.

#### Save user song:

1. Select the menu "SaveSong" sub menu and press [+ / YES] button, LCD displays the user song name and number. Use the data dial to select the file to save.
2. After selected the user song, press [+ / YES]. The LCD prompts to enter file name "SNG\_". Now use keyboard to enter 8 character file name.
3. After entering the file name, press [+ / YES]. The LCD prompts to confirm the operation: "Sure?". Press [+ / YES] again to save the file. Press [- / NO] to cancel the operation.
4. If the name you enter is the same with the song name in USB Flash Drive, the LCD prompts "SameName!". You need to enter a different name to save file.  
Follow the steps above to save a user style or a user memory.

### Load

1. Press [USB DEVICE] button to enter USB mode. Then use data dial to select "Load" menu.
2. Press [+ / YES] to enter "load" submenu. Load submenu are displayed on LCD, it includes "LoadSong", "LoadSty", "LoadMem". Use [+ / YES], [- / NO] button or data dial to select one.

#### Load Song:

1. Select the menu "LoadSong" and press [+ / YES] button, LCD displays the MIDI files (\*.midi) in the MMKD\SONG directory of USB Flash Drive. Use the data dial to select the file to load.
2. After selected the midi file, press [+ / YES] button, and then use the data dial to select user song number.
3. After selected the song number, press [+ / YES] button, and the LCD displays "Sure?". Press [+ / YES] again to confirm the loading operation. Press [- / NO] to cancel the that operation.

#### Load Style

1. Select the menu "LoadSty" and press [+ / YES] button, LCD displays the style files (\*.sty) in the MMKD\STYLE directory of USB Flash Drive. Use the data dial to select the file to load.
2. After selected the style file, press [+ / YES] button, and then use the data dial to select user style number.
3. After selected the user style number, press [+ / YES] button, and the LCD displays "Sure?". Press [+ / YES] again to confirm the loading operation. Press [- / NO] to cancel the that operation.

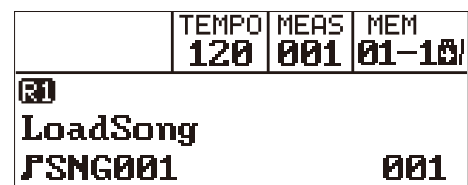
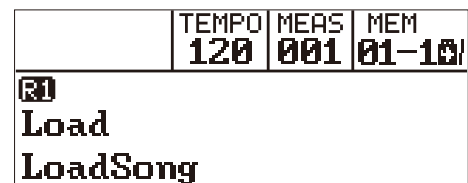
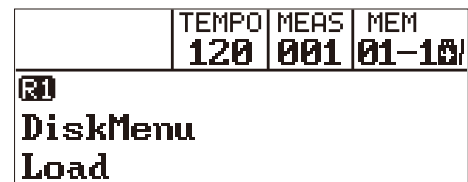
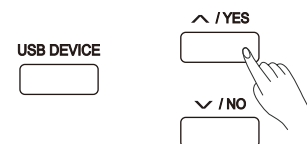
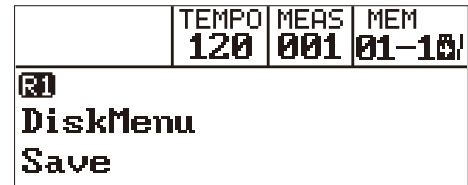
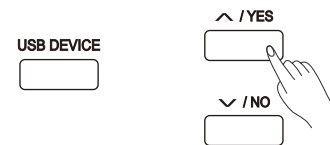

## Connecting USB Flash Drive

### Load Memory

1. Select the menu "LoadMem" and press [+ / YES] button, LCD displays the memory files (\*.mem) in the MMKDMEMORY directory of USB Flash Drive. Use the data dial to select the file to load.
2. After selected the memory file, press [+ / YES] button, and then use the data dial to select user memory number.
3. After selected the user memory number, press [+ / YES] button, and the LCD displays "Sure?". Press [+ / YES] again to confirm the loading operation. Press [- / NO] to cancel the that operation.

### Delete

1. Press [USB DEVICE] button to enter USB mode. Then use data dial to select "Delete".
2. Press [+ / YES] to enter "Delete" sub menu. It includes "UserSong", "UserSty", "UserMem". Use [+ / YES], [- / NO] button or data dial to select one.
3. After selected file type to delete, press [+ / YES] to enter the corresponding menu.
4. After selected the file to delete, press [+ / YES], and the LCD displays "Sure?". Press [+ / YES] to confirm, and press [- / NO] to cancel the operation.

### Format

1. Press [USB DEVICE] button to enter USB mode. Then use data dial to select "Format".
2. Press [+ / YES] to confirm. LCD displays "Sure?", then press [+ / YES] to format, press [- / NO] to cancel operation.

**Note:**

Formation will delete all data in USB Flash Drive!

### Keyboard and ASCII Character Relative Table

NOTE	C#2	D2	Eb2	E2	F2	F#2	G2	Ab2	A2	Bb2	B2
LETTER	DEL	BACK	NEXT	A	B	C	D	E	F	G	H

NOTE	C3	C#3	D3	Eb3	E3	F3	F#3	G3	Ab3	A3	Bb3
LETTER	I	J	K	L	M	N	O	P	Q	R	S

NOTE	B3	C4	C#4	D4	Eb4	E4	F4	F#4	G4	Ab4	A4
LETTER	T	U	V	W	X	Y	Z	0	1	2	3

NOTE	Bb4	B4	C5	C#5	D5	Eb5
LETTER	4	5	6	7	8	9

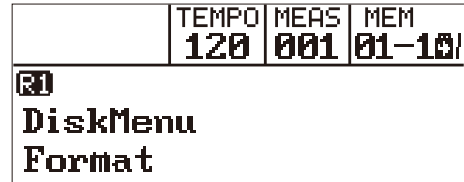
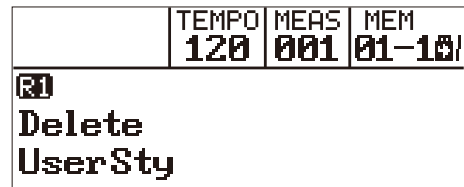
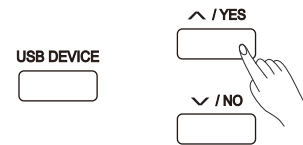
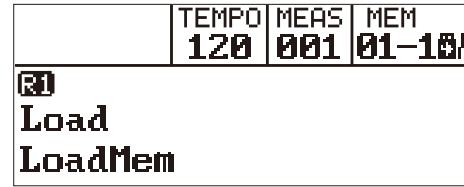

# MIDI

By using the MIDI functions you can expand your musical possibilities. This section explains what MIDI is, and what it can do, as well as how you can use MIDI on your instrument.

## What's MIDI?

MIDI (short for Musical Instrument Digital Interface) allows a wide variety of electronic musical instruments, computers and other related devices to connect and communicate with one another. MIDI carries event messages that specify notation, pitch and velocity, control signals for parameters such as volume, vibrato, audio panning, and program change information to change the voice selections.

The instrument can output the real-time playback information via MIDI messages and control external MIDI devices. The instrument can also accept incoming MIDI messages and generate sound accordingly.

## MIDI Terminals

Connect the piano with external MIDI devices with a standard MIDI cable for the exchange of MIDI data.

**MIDI IN:** Receives MIDI data from a computer.

**MIDI OUT:** Transmits MIDI data from the piano to an external MIDI device.

**MIDI THRU PORT:** You can use MIDI cable to link the MIDI THRU port to other MIDI instrument MIDI IN port. The message that the MIDI IN port receives will be auto sent to the MIDI THRU port, so that one MIDI instrument can control many MIDI instrument at the same time.

Connect the MIDI OUT of other Device to the MIDI IN jack on the rear panel, this instrument will work as a sound module.

Connect the MIDI IN of other Device to the MIDI OUT jack on the rear panel. this instrument will work as a MIDI controller.

## Downloading Data from the Computer

Connect a standard USB cable between the rear-panel of the USB jack of the instrument and the USB jack on your computer.

Power on the instrument first, and then open the PCSUITE software in your computer, the "CONNECTING" will be displayed on LCD. The PCSUITE will connect successfully with the instrument.

You can download 10 SMF MIDI files to the keyboard as user songs or upload the user songs.

You can upload user styles to the computer as a backup or download them to the keyboard.

You can upload memory files to the computer as a backup or download them to the keyboard.

Please refer to software operation instructions for detail operating methods.

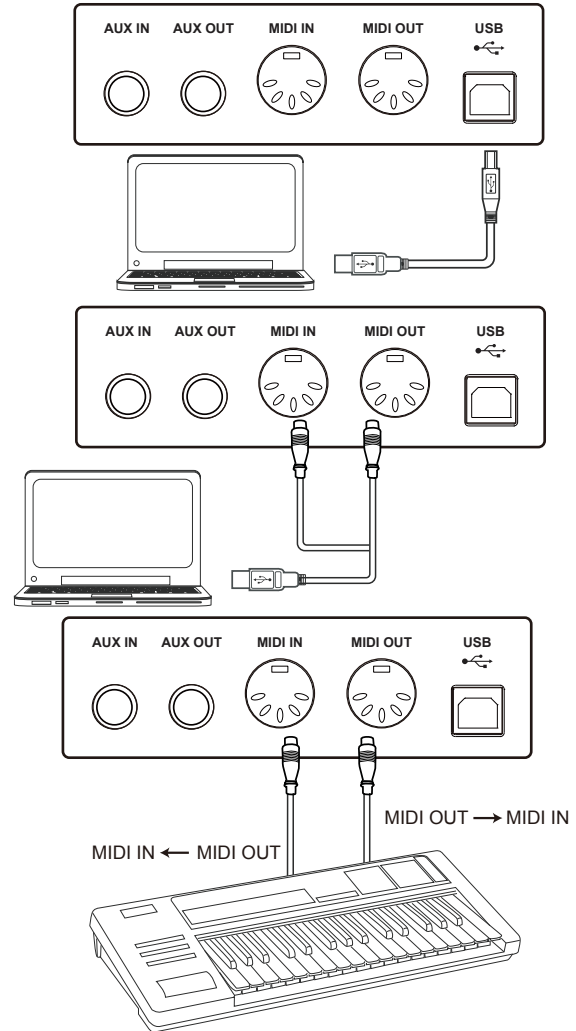

# Troubleshooting

Problem	Possible Cause and Solution
The speakers produce a pop sound whenever the power is turned ON or OFF.	This is normal and is no cause for alarm.
No sound when the keyboard is played.	Make sure the master volume is set to an appropriate level. Check if headphones are plugged into Jack 2. The R1/R2/L voice volume (Mixer) settings could be set too low. Make sure the voice volumes are set at appropriate levels.
When using a mobile phone, noise is produced.	Using a mobile phone in close proximity to the instrument may produce interference. To prevent this, turn off the mobile phone or use it further away from the instrument.
The auto accompaniment does not play back even Sync is in standby condition and a key is pressed.	You may be trying to start accompaniment by playing a key in the right-hand range of the keyboard. To start the accompaniment with Sync Start, make sure to play a key in the left-hand range of the keyboard.
Certain notes sound at wrong pitch.	Make sure that the tuning value is set to 0. Press and hold the [+ / YES] and [- / NO] buttons at the same time, then turning the power on will set INSTRUMENT to default.
The Harmony function does not operate.	Please make sure the Harmony function is on. And Harmony cannot be turned on when a drum kit is selected for the voice R1.
After connecting with the computer, the piano is not recognized.	Please check if the USB cable is being connected firmly, or try connecting another USB port of the computer, without the need to install another driver on the PC.

# Specifications

## LCD Display

Multi-functional LCD

## Keyboard

88 Hammer-Action Keys

## Polyphony

128

## Voice

600

## Song

120 preset songs, 10 user songs

## Style

230 preset styles, 10 user styles

## Demo

5

## Control button

Power Switch, Volume knob, Brilliance knob, Styles, Tempo+/-, Acc Vol, Mixer, Function+/-, Start/Stop, Sync Start, Intro/Ending, Fill A, Fill B, Fill C Fill D, Chord Mode, Voices, Dual, Lower, USB Device, Metro, Twinova, Octave, Song, Bank, Store, M1-M4, O.T.S., Shift, Demo, +/Yes, -/No, Data dial, Melody off L/R

## Record Function

Record, Accomp, Melody 1-5

## Memory

96

## Connectors

PHONES (2 standard. 1/4" phone), AUX IN, AUX OUT  
USB-MIDI, MIDI IN/OUT, USB Device Jack  
Pedals (Sustain, Soft, Sostenuto)

## Power Supply

AC 220~240V, 50Hz

## Speaker

HIGH 8Ω 10W X2  
LOW 6Ω 40W X2

## Dimensions

1375(L) x 543(W) x 905(H)

## Weight

52kg

\* All specifications and appearances are subject to change without notice.



# Voice List

No.	Full Name
<b>Piano</b>	
1	Acoustic Grand Piano
2	Acoustic Grand Piano 2
3	Acoustic Grand Piano 3
4	Acoustic Grand Piano (wide)
5	Acoustic Grand Piano (dark)
6	Bright Acoustic Piano
7	Bright Acoustic Piano 2
8	Bright Acoustic Piano 3
9	Bright Acoustic Piano (wide)
10	Electric Grand Piano
11	Electric Grand Piano 2
12	Electric Grand Piano (wide)
13	Electric Grand Piano (dark)
14	Honky Tonk Piano
15	Honky Tonk Piano 2
16	Honky Tonk Piano (wide)
17	Honky Tonk Piano (dark)
18	Harpsichord
19	Harpsichord 2
20	Harpsichord (octave mix)
21	Harpsichord (wide)
22	Harpsichord (with key off)
23	Octave Grand Piano
24	Octave Grand Piano 2
25	Piano & Strings
26	Piano & Pad
27	Piano & Choir
28	Piano & EP
29	Piano & Vibraphone
30	Detuned Electric Piano
31	Detuned Electric Piano 2
32	Electric Piano
33	Electric Piano 2
34	Electric Piano 3
35	Electric Piano 4
36	Electric Piano 1 (velocity mix)
37	Electric Piano 2 (velocity mix)
38	60's Electric Piano
39	EP Legend
40	Phase EP
41	Clavi
42	Clavi 2
43	Phase Clavi
44	Wah Clavi
45	Pulse Clavi
46	Dream EP
47	Tremolo EP
48	Funk EP
49	Warm EP
50	Choir EP
51	Wah EP
52	Modern EP
53	EP Pad
<b>Chromatic Percussion</b>	
54	Celesta
55	Celesta 2

56	Celesta 3
57	Glockenspiel
58	Glockenspiel 2
59	Music Box
60	Music Box 2
61	Music Box 3
62	Vibraphone
63	Vibraphone 2
64	Vibraphone (wide)
65	Marimba
66	Marimba 2
67	Marimba (wide)
68	Xylophone
69	Xylophone 2
70	Xylophone 3
71	Tubular Bells
72	Tubular Bells 2
73	Church Bell
74	Carillon
75	Dulcimer
76	Dulcimer 2
77	Santur
<b>Organ</b>	
78	Italian 60's Organ
79	Drawbar Organ
80	Drawbar Organ 2
81	Detuned Drawbar Organ
82	Drawbar Organ 3
83	Detuned Percussive Organ
84	Percussive Organ
85	Percussive Organ 2
86	70's Percussive Organ
87	Percussive Organ 3
88	Rock Organ
89	Rock Organ 2
90	Rock Organ 3
91	Church Organ
92	Church Organ 2
93	Church Organ 3
94	Church Organ (octave mix)
95	Detuned Church Organ
96	Reed Organ
97	Reed Organ 2
98	Rotary Organ
99	Puff Organ
100	Accordion
101	Accordion 2
102	Accordion 3
103	Harmonica
104	Harmonica 2
105	Harmonica 3
106	Tango Accordion
107	Tango Accordion 2
<b>Guitar</b>	
108	Acoustic Guitar (nylon)
109	Acoustic Guitar (nylon) 2
110	Acoustic Guitar (nylon) 3
111	Acoustic Guitar (nylon + key off)



## Voice List

112	Ukulele
113	Acoustic Guitar (steel)
114	Acoustic Guitar (steel) 2
115	12-Strings Guitar
116	Mandolin
117	Mandolin 2
118	Steel Guitar with Body Sound
119	Electric Guitar (jazz)
120	Electric Guitar (jazz) 2
121	Electric Guitar (pedal steel)
122	Electric Guitar (clean)
123	Electric Guitar (clean) 2
124	Electric Guitar (detuned clean)
125	Mid Tone Guitar
126	Electric Guitar (muted)
127	Electric Guitar (muted) 2
128	Electric Guitar (funky cutting)
129	Electric Guitar (muted velo-sw)
130	Jazz Man
131	Overdriven Guitar
132	Overdriven Guitar 2
133	Guitar Pinch
134	Distortion Guitar
135	Distortion Guitar 2
136	Distortion Guitar (with feedback)
137	Guitar Feedback
138	Distorted Rhythm Guitar
139	Guitar Harmonics
140	Guitar Harmonics 2
141	Velocity Nylon Guitar
<b>Bass</b>	
142	Acoustic Bass
143	Acoustic Bass 2
144	Wah Bass
145	Electric Bass (finger)
146	Finger Slap Bass
147	Electric Bass (pick)
148	Electric Bass (pick) 2
149	Fretless Bass
150	Fretless Bass 2
151	Slap Bass
152	Slap Bass 2
153	Slap Bass 3
154	Slap Bass 4
155	Synth Bass
156	Synth Bass 2
157	Synth Bass 3
158	Synth Bass 4
159	Warm Synth Bass
160	Rsonance SynBass
161	Clavi Bass
162	Hammer
163	Attack Bass
164	Synth Bass (rubber)
165	Synth Bass (rubber) 2
166	Attack Pulse
<b>Strings &amp; Orchestral</b>	
167	Violin
168	Violin 2

169	Violin (slow attack)
170	Viola
171	Viola 2
172	Cello
173	Cello 2
174	Contrabass
175	Contrabass 2
176	Tremolo Strings
177	Tremolo Strings 2
178	Tremolo Strings 3
179	Pizzicato Strings
180	Pizzicato Strings 2
181	Orchestral Harp
182	Orchestral Harp 2
183	Yang Chin
184	Timpani
185	Timpani 2
186	String Ensembles
187	String Ensembles 2
188	String Ensembles 3
189	String Ensembles 4
190	Strings & Brass
191	60's Strings
192	Synth Strings
193	Synth Strings 2
194	Synth Strings 3
195	Synth Strings 4
196	Synth Strings 5
197	Choir Aahs
198	Choir Aahs 2
199	Choir Aahs 3
200	Voice Oohs
201	Voice Oohs 2
202	Humming
203	Anlong Voice
204	Synth Voice
205	Synth Voice 2
206	Orchestra Hit
207	Orchestra Hit 2
208	Bass Hit Plus
209	6th Hit
210	Euro Hit
<b>Brass</b>	
211	Trumpet
212	Trumpet 2
213	Dark Trumpet
214	Trombone
215	Trombone 2
216	Trombone 3
217	Bright Trombone
218	Tuba
219	Tuba 2
220	Muted Trumpet
221	Muted Trumpet 2
222	Muted Trumpet 3
223	French Horn
224	French Horn 2
225	French Horn 3

# Voice List

226	Brass Section
227	Brass Section 2
228	Brass Section 3
229	Synth Brass
230	Synth Brass 2
231	Synth Brass 3
232	Synth Brass 4
233	Synth Brass 5
234	Synth Brass 6
235	Synth Brass 7
236	Synth Brass 8
237	Analog Synth Brass
238	Analog Synth Brass 2
239	Analog Synth Brass 3
240	Jump Brass
241	Jump Brass 2
242	Funny
243	Funny 2
<b>Reed</b>	
244	Soprano Sax
245	Soprano Sax 2
246	Soprano Sax 3
247	Alto Sax
248	Alto Sax 2
249	Alto Sax 3
250	Tenor Sax
251	Tenor Sax 2
252	Tenor Sax 3
253	Baritone Sax
254	Baritone Sax 2
255	Baritone Sax 3
256	Oboe
257	Oboe 2
258	Oboe 3
259	2 Oboes
260	English Horn
261	English Horn 2
262	English Horn 3
263	2 English Horns
264	Bassoon
265	Bassoon 2
266	Bassoon 3
267	2 Bassoons
268	Clarinet
269	Clarinet 2
270	Clarinet 3
271	2 Clarinets
<b>Pipe</b>	
272	Piccolo
273	Piccolo 2
274	Piccolo 3
275	2 Piccolos
276	Sweet Flute
277	Flute
278	Flute 2
279	Flute 3
280	2 Flutes
281	Recorder

282	Recorder 2
283	2 Recorders
284	Pan Flute
285	Pan Flute 2
286	Sweet Pan Flute
287	Blown Bottle
288	Blown Bottle 2
289	Shakuhachi
290	Shakuhachi 2
291	Whistle
292	Whistle 2
293	Ocarina
294	Ocarina 2
<b>Synth Lead</b>	
295	Lead 1 (square)
296	Lead 1a (square) 2
297	Lead 1 (square) 3
298	Lead 1b (sine)
299	Lead 2 (sawtooth)
300	Lead 2a (sawtooth) 2
301	Lead 2 (sawtooth) 3
302	Lead 2b (saw + pulse)
303	Lead 2c (double sawtooth)
304	Lead 2d (sequenced analog)
305	Lead 2d (sequenced analog) 2
306	Wavy Sawtooth
307	Bauble Lead
308	Super Analog
309	Lead 3 (calliope)
310	Lead 3 (calliope) 2
311	Lead 4 (chiff)
312	Lead 4 (chiff) 2
313	Lead 4 (chiff) 3
314	Lead 5 (charang)
315	Lead 5 (charang) 2
316	Lead 5 (charang) 3
317	Lead 5 (charang) 4
318	Lead 5a (wire lead)
319	Lead 5a (wire lead) 2
320	Lead 6 (voice)
321	Lead 6 (voice) 2
322	Lead 7 (fifths)
323	Lead 7 (fifths) 2
324	Lead 8 (bass + lead)
325	Lead 8 (bass + lead) 2
326	Lead 8 (bass + lead) 3
327	Lead 8a (soft wrl)
328	Massiness
329	Square
330	Slow Square Lead
331	Sine Solo
332	Square Lead 4
333	Thick Square
334	2Oscillators Lead
335	Wavy Sawtooth 2
336	Analog Lead
337	Big Lead
338	Fat Lead

## Voice List

339	PWM 4th	395	Warm Air	451	Analog Cymbal
340	Delayed Lead	396	FX 5 (brightness)	452	Ride Cymbal
341	Delayed Lead 2	397	Smog	453	China Cymbal
342	Fifth Lead	398	FX 6 (goblins)	454	Ride Bell
343	Corrie	399	FX 6 (goblins) 2	455	Tambourine
344	Quint	400	Choir Bell	456	Splash Cymbal
<b>Synth Pad</b>		401	Choir Bell 2	457	Cowbell
345	Pad 1 (new age)	402	FX 7 (echoes)	458	Analog Cowbell
346	Pad 1 (new age) 2	403	FX 7 (echoes) 2	459	High Bongo
347	Pad 2 (warm)	404	FX 7b (echo pan)	460	Low Bongo
348	Pad 2 (warm) 2	405	FX 7a (echo bell)	461	Mute Hi Conga
349	Pad 2a (sine pad)	406	FX 7a (echo bell) 2	462	Open Hi Conga
350	Pad 3 (polysynth)	407	FX 7a (echo bell) 3	463	Low Conga
351	Pad 3 (polysynth) 2	408	FX 8 (sci-fi)	464	Analog Hi Conga
352	Pad 3 (polysynth) 3	409	FX 8 (sci-fi) 2	465	Analog Mid Conga
353	Pad 3 (polysynth) 4	<b>Ethnic Misc.</b>		466	Analog Low Conga
354	Pad 4 (choir)	410	Sitar	467	High Timbale
355	Pad 4 (choir) 2	411	Sitar 2	468	Low Timbale
356	Pad 4a (itopia)	412	Banjo	469	Cabasa
357	Pad 5 (bowed)	413	Banjo 2	470	Maracas
358	Pad 5 (bowed) 2	414	Shamisen	471	Analog Maracas
359	Pad 6 (metallic)	415	Shamisen 2	472	Short Guiro
360	Pad 6 (metallic) 2	416	Koto	473	Long Guiro
361	Pad 7 (halo)	417	Koto 2	474	Claves
362	Pad 7 (halo) 2	418	Taisho Koto	475	Mute Cuica
363	Pad 8 (sweep)	419	Kalimba	476	Open Cuica
364	Pad 8 (sweep) 2	420	Kalimba 2	477	Mute Triangle
365	Pad 8 (sweep) 3	421	Bag Pipe	478	Open Triangle
366	Pan Pad	422	Bag Pipe 2	479	Shaker
367	Pan Pad 2	423	Fiddle	480	Mute Surdo
368	Dipolar Pad	424	Fiddle 2	481	Open Surdo
369	PWM Pad	425	Fiddle 3	482	Melodic Tom
370	Warmly Pad	426	Shanai	483	Melodic Tom 2
371	Horn Pad	427	Shanai 2	484	Synth Drum
372	Click Pad	<b>Percussive</b>		485	Rhythm Box Tom
373	Analog Pad	428	Tinkle Bell	486	Electric Drum
374	80's Poly Pad	429	Agogo	487	Reverse Cymbal
375	PWM 4th Soft	430	Steel Drums	<b>SFX</b>	
376	Synth Calliope Soft	431	Woodblock	488	Guitar Fret Noise
377	Soft Vox	432	Castanets	489	Guitar Cutting Noise
378	5th SawWave	433	Taiko Drum	490	Acoustic Bass String Slap
379	5th Lead Soft	434	Concert Bass Drum	491	Breath Noise
380	Slow Square	435	Acoustic Bass Drum	492	Flute Key Click
381	New Year Pad	436	Jazz Kick	493	Seashore
382	Space Voice	437	Side Stick	494	Rain
383	Rising	438	Analog Rim Shot	495	Thunder
384	Congregate	439	Acoustic Snare	496	Wind
<b>Synth SFX</b>		440	Jazz Snare	497	Stream
385	FX 1 (rain)	441	Brush Tap	498	Bubble
386	FX 1 (rain) 2	442	Concert SD	499	Bird Tweet
387	FX 2 (soundtrack)	443	Hand Clap	500	Bird Tweet 2
388	FX 2 (soundtrack) 2	444	Tom	501	Dog
389	Prelude	445	Brush Tom	502	Horse Gallop
390	FX 3 (crystal)	446	Closed Hi-hat	503	Telephone Ring
391	FX 3 (crystal) 2	447	Analog Closed Hi-hat	504	Telephone Ring 2
392	FX 3a (synth mallet)	448	Pedal Hi-hat	505	Door Creaking
393	FX 4 (atmosphere)	449	Open Hi-hat	506	Door
394	FX 4 (atmosphere) 2	450	Crash Cymbal	507	Scratch

# Voice List

508	Wind Chime
509	Helicopter
510	Car Engine
511	Car Stop
512	Car Pass
513	Car Crash
514	Siren
515	Train
516	Jetplane
517	Starship
518	Burst Noise
519	Applause
520	Laughing
521	Screaming
522	Punch
523	Heart Beat
524	Footsteps
525	Gunshot
526	Machine Gun
527	Lasergun
528	Explosion
<b>Combined Voice</b>	
529	Stereo Piano & Strings Pad
530	Stereo Piano & Choir
531	Stereo Piano & Synth Strings
532	Stereo Piano & Warm Pad
533	Stereo Piano & Soft EP
534	FM Electric Piano
535	Digital Piano
536	E.Piano & Strings
537	E.Piano & Acoustic Guitar
538	E.Piano & Vibraphone
539	E.Piano 2 & Pad
540	E.Piano 2 & Strings
541	Harpichord & Stereo Strings
542	Music Box & Stereo Strings
543	Vibraphone & Stereo Strings
544	Vibraphone Octave
545	Vibraphone & Marimba & Kalimba
546	Marimba & Kalimba
547	Marimba Delay
548	Xylophone Octave
549	Organ & Stereo Strings
550	Stereo Organ & Piano
551	Rock Organ & Strings
552	Church Organ & Choir
553	Church Organ & Strings
554	Acoustic Guitar & Flute
555	Acoustic Guitar & Clavi
556	24 String Guitar
557	Steel Guitar & Warm Pad
558	Stereo Strings & Horn
559	Orchestra
560	Full Strings
561	Full Strings 2
562	Symphonic
563	Stereo Choir & Strings
564	Stereo Choir & Steel Guitar

565	3 Trumpet Loose
566	Trombone & Stereo Strings
567	3 Trombones Loose
568	3 Muted Trumpets Loose
569	Club Brass
570	Brass & Woodwinds
571	Woodwinds & Strings
572	Section Woods Small
573	Pan Flute & Strings Pad
574	Koto & Shamisen
575	Flute & Clarinet
576	Flute & Oboe
577	Flute & Bassoon
578	Flute & Oboe & Clarinet
579	Flute & Clarinet & Bassoon
580	Flute & Oboe & Bassoon
581	Flute Octave
582	Flute & Oboe Octave
583	Flute & Clarinet Octave
584	Oboe & Bassoon
585	Oboe & Clarinet
586	Oboe & Clarinet & Bassoon
587	Oboe Octave
588	Oboe & Clarinet Octave
589	Oboe & Bassoon Octave
590	Clarinet & Bassoon
591	Clarinet & Oboe Octave
<b>Drums</b>	
592	Standard Set
593	Room Set
594	Power Set
595	Electronic Set
596	Analog Set
597	Jazz Set
598	Brush Set
599	Orchestra Set
600	SFX Set

# Style List

NO.	Name
<b>8 BEAT</b>	
1	8Beat Ballad
2	8Beat Piano
3	8Beat 1
4	Guitar Pop 1
5	8Beat Hip Hop
6	8Beat Blues Rock
7	8Beat Pop
8	Pop Funk 1
9	Rhythm&Beat 1
10	8Beat Disco 1
11	8Beat Rock
12	Guitar Pop 2
13	8Beat 2
14	Sweet Beat
15	8Beat Dance
16	8Beat Disco 2
17	Pop Funk 2
18	8Beat 3
19	60's 8Beat
20	Rhythm&Beat 2
<b>16 BEAT</b>	
21	16Beat 1
22	16Beat Funk 1
23	16Beat Ballad 1
24	16Beat R&B
25	Pop 16Beat 1
26	16Beat Funk 2
27	16Beat Dance
28	Pop 16Beat 2
29	16Beat 2
30	Pop 16Beat 3
31	Pop 16Beat 4
32	Modern 16Beat
33	16Beat Hot
34	16Beat Modern
35	16Beat Funk 3
36	16Beat 3
37	Cool Beat
38	16Beat Ballad 2
39	16Beat 4
40	Pop Shuffle
<b>POP &amp; BALLAD</b>	
41	Pop Rock 1
42	Pop Dance 1
43	Pop Fusion
44	Analog Night 1
45	6/8 Pop
46	Brit. Pop 1
47	Brit. Pop 2
48	Pop Hit
49	Fusion Shuffle
50	Analog Night 2
51	Guitar Pop 3
52	Pop Beat
53	Soft Beat
54	60's Pop

55	Sting Latin
56	R&B Ballad 1
57	Guitar Ballad
58	Ballad Rock
59	Piano Pop
60	Soft Ballad
61	Natural Ballad
62	Love Ballad
63	Easy Ballad
64	Miami Folk
65	Slow Ballad
66	Folk Ballad
67	Pop Ballad 1
68	Pop Ballad 2
69	EP Ballad
70	New R&B Ballad
<b>ROCK</b>	
71	Rock
72	New Wave
73	Ska
74	Pop Rock 2
75	Slow Rock
76	70's Rock&Roll
77	Folk Rock
78	Soft Rock
79	Old Rock
80	Easy Rock
81	New Shuffle
82	Rock Hip Hop
83	Rock&Roll 1
84	Rock Shuffle
85	Rock&Roll 2
<b>BALLROOM</b>	
86	Tango 1
87	Spain Matador
88	Twist 1
89	Twist 2
90	Big Band Fox
91	Tango 2
92	Slow Fox
93	Slow Waltz 1
94	Swing Fox
95	Salsa 1
96	Cha Cha 1
97	Cha Cha 2
98	Beguine 1
99	Beguine 2
100	Rumba 1
101	Samba 1
102	Samba 2
103	Jive
104	Fox Trot
<b>DANCE</b>	
105	Techno 1
106	Hip Hop 1
107	House 1
108	Down Beat
109	Progressive

110	Rap 1
111	Disco
112	Soft Disco
113	70's Disco
114	Club Dance
115	Euro Dance
116	Garage
<b>SOUL &amp; FUNK</b>	
117	Funk 1
118	Classic Funk
119	Jay R&B
120	Gospel Swing
121	Gospel
122	Funk 2
123	Electric Funk
124	Groove Funk
125	Rubber Funk
126	Cool Funky
127	Jazz Funk
128	Groove
129	Soul
130	Hip Hop Soul
131	Hip Hop Beat
132	R&B
133	Soul Beat
134	British Soul Pop
135	Latin Jazz 1
136	Big Band 1
137	Dixieland 1
138	Guitar Swing 1
139	Broadway Big Band
140	Swing
141	Latin Jazz 2
142	Fusion
143	Acid Jazz
144	Cool Jazz Ballad
145	Swing Shuffle
146	Big Band Medium
147	Dixieland 2
148	Acoustic Jazz
149	Guitar Swing 2
150	Ragtime
151	Modern Jazz Ballad
152	Swing Ballad
153	Orchestra Swing
<b>COUNTRY</b>	
154	Country Pop 1
155	Bluegrass 1
156	8Beat Country
157	Modern Country
158	Country Pop 2
159	Bluegrass 2
160	2/4 Country
161	Country Quick Steps
162	Country Folk
163	Country Shuffle
<b>LATIN&amp;LATIN DANCE</b>	
164	Samba 3

# Style List

165	Bossa Nova
166	Latin
167	New Reggae
168	Reggae Dance
169	Paso Doble
170	Lite Bossa
171	Latin Rock
172	Beguine 3
173	Slow Bolero
174	Disco Samba
175	Mambo
176	Meneito
177	Rumba 2
178	Rumba 3
179	Tikitikita
180	Lambada
181	Pop Cha Cha 1
<b>WALTZ&amp;TRADITIONAL</b>	
182	Waltz
183	Old Waltz
184	English Waltz
185	German Waltz
186	Italian Mazurka
187	Mexico Waltz
188	Vienna Waltz
189	Slow Waltz 2
190	Jazz Waltz
191	Polka
192	6/8 March
193	German Polka
194	Party Polka
195	Army March
196	March
197	US March
198	Musette
199	French Musette
200	Mazurka
<b>WORLD</b>	
201	Enka Ballad
202	Laendler
203	Hawaiian
204	Sirtake
205	Dangdut
206	6/8 Flipper
207	New Age
208	Tarantella
209	Scottish
210	Norteno
<b>PIANIST</b>	
211	Pianist 1
212	Pianist 2
213	Pianist 3
214	March 1
215	March 2
216	Pop Waltz
217	Slow Waltz
218	Pop Bossa
219	Jazz Pub

220	Jazz 1
221	Jazz 2
222	Piano Rock
223	Blues 1
224	Piano Beat
225	Piano Bar
226	Pop 1
227	Pop 2
228	Ballad 1
229	Ballad 2
230	6/8 Ballad

# Song List

No.	Name	LCD Name
<b>FOLK &amp; COUNTRY</b>		
1	Toccata	Toccata
2	Carry Me Back To Old Virginny	Virginny
3	El Condor Pasa	ElCondor
4	Traumerei	Traumere
5	Aloha Oe	AlohaOe
6	Greensleeves	Sleeves
7	Home Sweet Home	SwetHome
8	Heidenroslein	Heidenro
9	Long Long Ago	LongAgo
10	Die Lorelei	Lorelei
11	Over The Waves	OverWave
12	My Darling Clementine	Clemtine
13	Gwine To Run All Night	Gwine
14	Symphony No.6 "Pathetic"	Sympony6
15	Oh! Susanna	Susanna
16	Prelude Op.28 No.15	Prelude
17	The House Of The Rising Sun	RiseSun
18	Menuet	Menuet
<b>GOLDEN &amp; POP</b>		
19	Valse Des Fleurs	Fleurs
20	Fruhlingsstimmen	Fruhling
21	Frohlicher Landmann	Landmann
22	Are You Lonesome Tonight?	Lonesome
23	Toy Symphony	ToySymph
24	Auld Lang Syne	LangSyne
25	Ave Maria	AveMaria
26	Tales Of Hoffman	Hoffman
27	La Donne Mobile	DoneMble
28	Serenata	Serenata
29	Bridal March	Bridal
30	Can't Help Fallin' In Love	InLove
31	Chanson Du Toreador	Toreador
32	Danny Boy	DannyBoy
33	Ich Liebe Dich	LieDich
34	Wiegenlied 2	Wieglied2
35	Spanish Serenade	Serenade
36	Piano Concerto	Concerto
37	Piano Concerto 2	Concrto2
38	Madame Butterfly	Madame
39	Invitation To The Dance	ToDance
40	Wiegenlied 3	Wieglied3
41	Jingle Bells	JingBell
42	Joy To The World	JoyWorld
43	La Paloma	LaPaloma
44	My Bonnie	MyBonnie
45	La Reine De Saba	Saba
46	La Cucaracha	Cucarach
47	Little Brown Jug	BrownJug
48	Battle Hymne Of The Republic	BatlHyme
49	Yellow Rose Of Texas	YellRose
50	The Wabash Cannon Ball	CannBall
51	Annie Laurie	AnnieLa
52	Turkish March	Turkish
53	An Die Musik	Musik
54	Lieder Ohne Worte Op.62 No.6	Lieder

55	Red River Valley	RedRiver
56	Die Forelle	Forelle
57	Symphony No. 94 "Suprise"	No. 94
58	Polonaise	Polonais
59	Rondeau	Rondeau
60	Moments Musicaux	Musicaux
61	Silent Night	SltNight
62	Moldau	Moldau
63	Summertime	Summer
64	Dreaming Of Home And Mother	Dreaming
65	Ring Ring De Banjo	DeBanjo
66	Der Lindenbaum	DerLinde
67	Zigeunerweisen	Zigeuner
68	The Maiden's Prayer	Prayer
69	Fur Elise	FurElise
70	Der Freischutz	DerFreis
71	Maria! Mari!	Maria!
<b>CLASSICAL</b>		
72	Waves Of The Danube	Danube
73	Santa Lucia	SantaLuc
74	Solveig's Song	Solveig
75	Piano Sonatan No. 8 In C Minor (Pathetique)	Patheque
76	Brahms Waltz	BrmsWltz
77	Aida	Aida
78	Carmen-Prelude	Carmen
79	L'Arlesienne	L'Arlesi
80	Ungarische Tanz	Ungaris
81	Mazurka	Mazurka
82	Pizzicato Polka	Polka
83	Menuett	Menuett
84	Rigoletto	Rigoletto
85	Serenade	Serenade
86	Song Without Words	SongNoWd
87	Swan	Swan
88	The Dying Swan	DyingSwn
89	Swan Lake Valse	SwnWalse
90	The Happy Farmer	HpFarmer
91	The Sleeping Beauty	SleepBty
92	La Traviata	LaTravia
93	Wiegenlied	Wiegenli
94	Mov. 2 Adagio Non Troppo Piano Sonata No. 9 In D	Sonata9
95	Piano Sonata No. 11 In A	Sonata11
96	Prelude In C	Prelude
97	Chinese Dance	ChDance
98	Emperor Waltz	Emperor
99	March Militaire	Militair
100	Symphony No. 40	Symphony
<b>PIANO</b>		
101	Hanon Piano Fingering 1	Hanon1
102	Hanon Piano Fingering 2	Hanon2
103	Hanon Piano Fingering 3	Hanon3
104	Hanon Piano Fingering 4	Hanon4
105	Hanon Piano Fingering 5	Hanon5
106	Basic Tutorial Beyer Piano 12	Beyer12
107	Basic Tutorial Beyer Piano 13	Beyer13
108	Basic Tutorial Beyer Piano 14	Beyer14



# Song List

109	Basic Tutorial Beyer Piano 15	Beyer15
110	Basic Tutorial Beyer Piano 18	Beyer18
111	Cuckoo	Cuckoo
112	Basic Tutorial Beyer Piano 21	Beyer21
113	Basic Tutorial Beyer Piano 29	Beyer29
114	Butterfly	Buterfly
115	Basic Tutorial Beyer Piano 45	Beyer45
116	Christmas Eve	XmasEve
117	Basic Tutorial Beyer Piano 50	Beyer50
118	Basic Tutorial Beyer Piano 52	Beyer52
119	Basic Tutorial Beyer Piano 55	Beyer55
120	Basic Tutorial Beyer Piano 59	Beyer59
<b>DEMO</b>		
1	Demo1	Demo1
2	Demo2	Demo2
3	Bossa Nova	Bossa Nova
4	Fusion	Fusion
5	Jazz	Jazz



# Chord List

Chord name [abbreviation]	Normal Voicing (For root C)	Chord	Display
Major [M]	1+3+5	C	C
Sixth [6]	1+(3)+5+6	C6	C6
Major seventh [M7]	1+3+(5)+7	CM7	CM7
Major seventh add sharp eleventh [M7(#11)]	1+(2)+3+#4+(5)+7	CM7(#11)	CM7(#11)
Major seventh add sharp eleventh (9)	1+2+3+5	C(9)	CM(9)
Major seventh ninth [M7(9)]	1+2+3+(5)+7	CM7(9)	CM7(9)
Sixth ninth [6(9)]	1+2+3+(5)+6	C6(9)	C6(9)
Augmented [aug]	1+3+#5	Caug	Caug
Minor [m]	1+b3+5	Cm	Cm
Minor sixth [m6]	1+b3+5+6	Cm6	Cm6
Minor seventh [m7]	1+b3+(5)+b7	Cm7	Cm7
Minor seventh flatted fifth [m7b5]	1+b3+b5+b7	Cm7b5	Cm7(b5)
Minor add ninth [m(9)]	1+2+b3+5	Cm(9)	Cm(9)
Minor seventh ninth [m7(9)]	1+2+b3+(5)+b7	Cm7(9)	Cm7(9)
Minor seventh eleventh [m7(11)]	1+(2)+b3+4+5+(b7)	Cm7(11)	Cm7(11)
Minor major seventh [mM7]	1+b3+(5)+7	CmM7	CmM7
Minor major seventh ninth [mM7(9)]	1+2+b3+(5)+7	CmM7(9)	CmM7(9)
Diminished [dim]	1+b3+b5	Cdim	Cdim
Diminished seventh [dim7]	1+b3+b5+6	Cdim7	Cdim7
Seventh [7]	1+3+(5)+b7	C7	C7
Seventh suspended fourth [7sus4]	1+4+5+b7	C7sus4	C7sus4
Seventh flatted fifth [7b5]	1+3+b5+b7	C7b5	C7(b5)
Seventh ninth [7(9)]	1+2+3+(5)+b7	C7(9)	C7(9)
Seventh add sharp eleventh [7(#11)]	1+2+3+#4+(5)+b7 or 1+(2)+3+#4+5+b7	C7(#11)	C7(#11)
Seventh add thirteenth [7(13)]	1+ 3+(5)+6+b7 or 2+ 3+5+6+b7	C7(13)	C7(13)
Seventh flatted ninth [7(b9)]	1+b2+3+(5)+b7	C7(b9)	C7(b9)
Seventh add flatted thirteenth [7(b13)]	1+3+5+b6+b7	C7(b13)	C7(b13)
Seventh sharp ninth [7(#9)]	(1)+#2+3+(5)+b7	C7(#9)	C7(#9)
Major seventh augmented [M7aug]	1+3+#5+7	CM7aug	CM7aug
Seventh augmented [7aug]	(1)+3+#5+b7	C7aug	C7aug
Suspended fourth [sus4]	1+4+5	Csus4	Csus4
One plus two plus five [sus2]	1+2+5	C/Csus2	C

# MIDI Implementation Chart

Function		Transmitted	Recognized	Remarks
Basic Channel	Default Changed	1ch 1-16ch	ALL 1-16ch	
Mode	Default Messages Altered	× × *****	3 3 ×	
Note Number	Note :True voice	0—127 *****	0—127 0—127	
Velocity	Note on Note off	○ 9nH,V=1-127 × (9nH,V=0)	○ 9nH,V=1-127 ○(9nH,V=0; 8nH,V=0-127)	
After Touch	key's Ch's	× ×	× ×	
Pitch Bend		○	○	
Control Change	0 1 5 6 7 10 11 64 65 66 67 80 81 91 93 120 121 123	○ × × ○ ○ × × ○ ○ ○ ○ × × ○ ○ ○ ○ × × ×	○ ○ ○ ○ ○ ○ ○ ○ ○ ○ ○ ○ ○ ○ ○ ○ ○ ○ ○ ○	Bank Select Modulation Portamento Time Data Entry Volume Pan Expression Sustain Pedal Portamento ON/OFF Sostenuto Pedal Soft Pedal Reverb Program Chorus Program Reverb Level Chorus Level All Sound Off Reset All Controllers All Notes Off
Program Change	:true	○ *****	○ 0—127	
System Exclusive		×	○	
System Common	:SongPosition :Song Select :Tune	× × ×	× × ×	
System Real Time	:Clock :Commands	× × *1	× ×	
Aux Messages	:LOCAL ON/OFF :Active sense :Reset	× × ×	× ○ ○	
Notes:	*1 When the accompaniment is started, an FAH message is transmitted. When accompaniment is stopped, an FCH message is transmitted.			

- Mode 1: OMNI ON, POLY
- Mode 2: OMNI ON, MONO

- Mode 3: OMNI OFF, POLY
- Mode 4: OMNI OFF, MONO

- : YES
- ×: NO

# Scale tuning system

A tuning system is the system used to define which tones, or pitches, to use when playing music. In other words, it is the choice of number and spacing of frequency values used. The equal temperament (has only one tuning method, and is suitable for keyboard) is the common musical scale used at present, used for the tuning of pianos and other instruments of relatively fixed scale. One of the advantages of the equal tempered scale is that it is the same in any musical "key", so that compositions may be freely transposed up or down without changing the musical intervals.

Especially for piano, equal temperament is widely used and taken for granted. But people used several other scales to compose and perform before adopting the equal temperament. This piano has been equipped with 6 scale tuning systems, you can select one to reappearing its matched chord of the melody at that time.

## Characteristics of Different Scale Tuning Systems

### Pythagorean

The Pythagorean tuning, named after the ancient mathematician and philosopher Pythagoras, is based on a stack of intervals called perfect fifths. It is particularly well suited to music which treats fifths as consonances, and thirds as dissonances.

### Pure Major & Pure Minor

In music, just intonation (sometimes abbreviated as JI) or pure intonation is any musical tuning in which the frequencies of notes are related by ratios of small whole numbers. Any interval tuned in this way is called a pure or just interval. And the major scale which consisted of just intonations especially for this triad chords: Root, Third, Fifth are sounded extremely harmony. The just intonation must be the most natural temperament.

### Meantone

The Meantone System is a musical temperament which is close to just intonation. Used to tuning pipe organ in 16th century Europe. These musical scales which based on the Pythagorean System, minus quarter of common comma for once, are extremely approaching just intonation. So, use this system to create musical scales are sound beautiful and pure, just like a perfect triad chord.

### Werckmeister

The Werkmeister was named after Andreas Werckmeister, and this scale was created as an improvement on the Pythagorean scale. This tuning collapse comma maxima, created by Pythagorean, into four perfect fifths, the rest fifths still remain their Pythagorean scale characteristics. Werkmeister Tuning can tune scale from harmonic to melodic by increasing tone number, making each tonality sound distinct, this is the important gist for classicists and romanticism tonality music to name the tone name.

### Kirnberger

Kirnberger temperament is an irregular temperament developed in the second half of the 18th century by Johann Kirnberger and regarded as an improved version of Meantone temperament. It makes possible to switch different tunes freely when performing.

### Twelve-tone equal temperament

In twelve-tone equal temperament, which divides the octave into 12 equal parts, the width of a semitone, i.e. the frequency ratio of the interval between two adjacent notes, is the twelfth root of two. There is minute difference of the same amount between each two intervals.

